

HUGO GERNSBACK, Editor

# RADIO CRAFT

250-300 MC  
DIRECTIONAL  
RADIOPHONE  
SEE PAGE 20

*In this issue—*

Television Sound Receiver  
Instability in Apparatus  
A Small Recording Studio

RADIO-ELECTRONICS IN ALL ITS PHASES

FEB  
1947

25¢  
CANADA 30¢



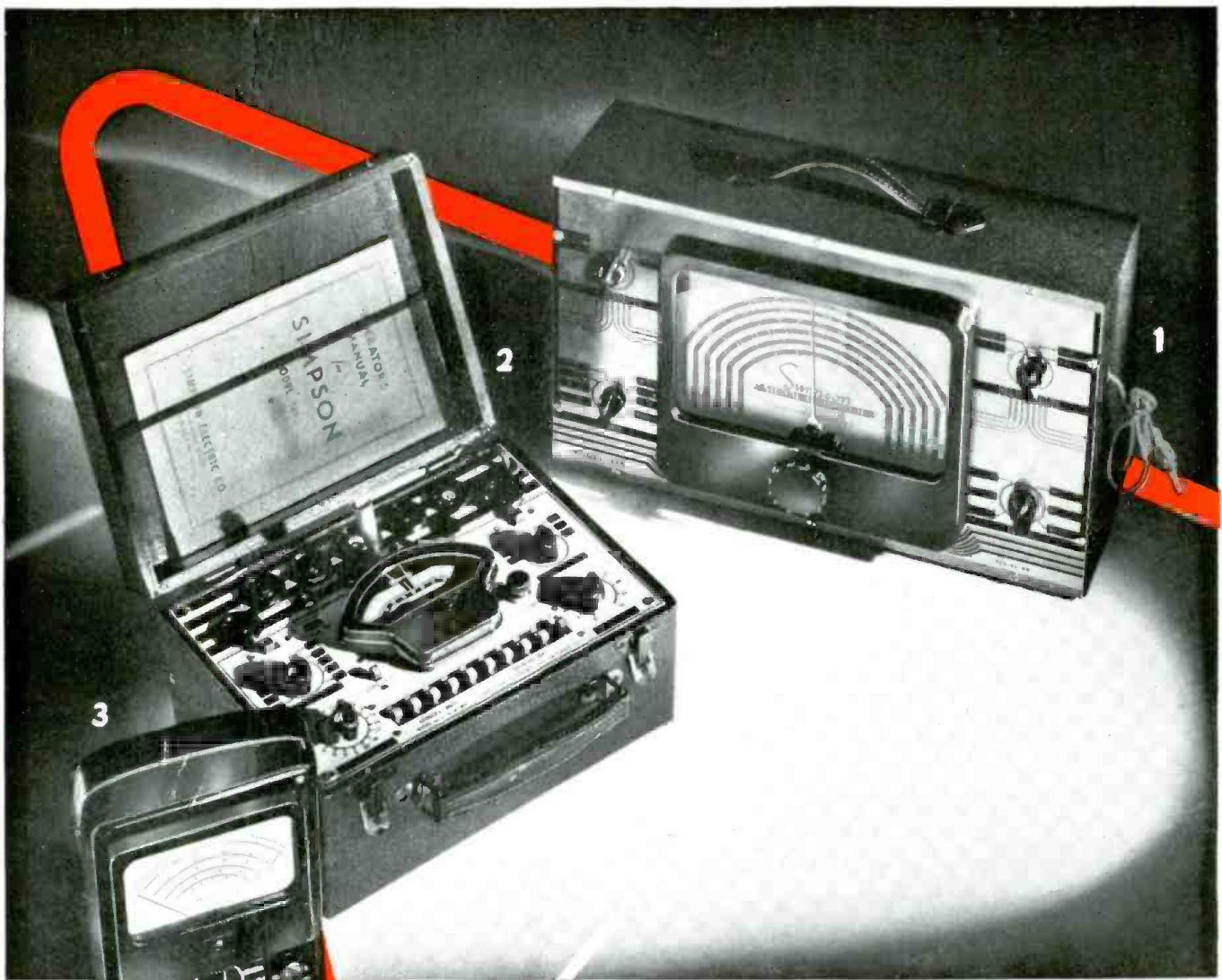

Model 315 Signal Generator. Designed down to the most minute detail for highest accuracy, greatest stability, minimum leakage, and good wave form .....\$67.35

Model 305 Tube Tester. Tests all tubes. Provides for filament voltages from .5 volts to and including 120 volts. Spare sockets for future tube developments....\$49.50

Model 260 High Sensitivity Set Tester. 20,000 ohms per volt. D.C. Voltage ranges to 5,000 volts A.C. and D.C. Resistance ranges to 20 megohms. Current ranges to 500 milliamperes.....\$38.95

## *This Simpson "Big 3"*

**... gives servicemen a real profit-making set-up**

- The successful radio serviceman today must have the finest in test instruments for a very practical reason—that's his only hope of present and continued profits. To meet the tremendous volume of business available he must be able to "trouble-shoot" fast and *accurately* every time. Only thus can he correct trouble speedily, with satisfaction to the customers.

Simpson offers you, in three basic test instruments, the accuracy and advanced electronic engineering which have given Simpson the proudest name in the industry. They are tried-and-tested examples of the kind of instruments Simpson has always built. Their use will demonstrate that from Simpson alone can you expect "instruments that stay accurate" with construction and design that lead the field.

To dealer and to serviceman alike, Simpson offers today the assurance of continued profits that only quality can give. No Simpson instrument is ever marketed, or ever will be, unless its makers feel that, of its kind, nothing finer can be produced.

# Simpson

INSTRUMENTS THAT STAY ACCURATE

SIMPSON ELECTRIC COMPANY  
5200-5218 West Kinzie Street, Chicago 44



# I WILL TRAIN YOU TO START A SPARE TIME OR FULL TIME RADIO SERVICE BUSINESS WITHOUT CAPITAL

J. E. SMITH,  
PRESIDENT  
National Radio  
Institute  
33rd Year of  
Training Men  
for success  
in Radio

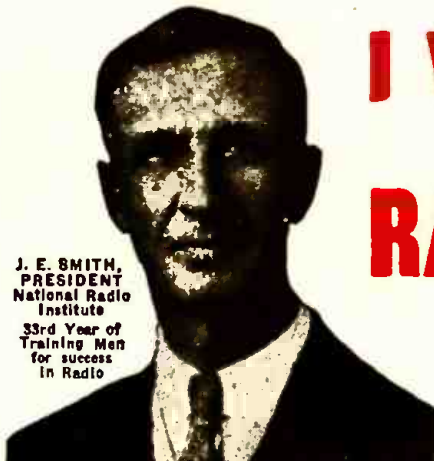

## You Build These and Many Other Radio Circuits with Big Kits of Parts I Supply

By the time you've conducted 60 sets of Experiments with Radio Parts I supply, made hundreds of measurements and adjustments, you'll have valuable PRACTICAL Radio experience for a good full or part-time Radio job!

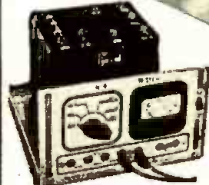

You build MEASURING INSTRUMENT above early in Course, useful for Radio work to pick up EXTRA spare time money. It is a vacuum tube multimeter, measures A.C., D.C., R.F. volts, D.C. currents, resistance, receiver output.

Building the A. M. SIGNAL GENERATOR at right will give you valuable experience. Provides amplitude-modulated signals for test and experimental purposes.



You build the SUPERHETERODYNE CIRCUIT above containing a preselector oscillator-mixer-first detector, i.f. stage, diode-detector-a.v.c. stage and audio stage. It will bring in local and distant stations. Get the thrill of learning at home evenings in spare time while you put the set through fascinating tests!

APPROVED  
for training  
under  
G.I.BILL

The men at the right are just a few of many I have trained, at home in their spare time, to be Radio Technicians. They are now operating their own successful spare-time or full-time Radio businesses. Hundreds of other men I trained hold good jobs in practically every branch of Radio. Doesn't this PROVE my "50-50 method" of home training can give you BOTH a thorough knowledge of Radio principles and the PRACTICAL experience you need to help you make more money in the fast-growing Radio industry?

Let me send you facts about opportunities in the busy Radio field. See how knowing Radio can give you security, a prosperous future... lead to jobs coming in Television, Electronics. Send coupon NOW for FREE Sample Lesson and 64-page, illustrated book. Read how NRI trains you at home in spare time. Read how you practice building, testing, repairing Radios with BIG KITS of Radio parts I send you.

### Many Beginners Soon Make Extra Money in Spare Time While Learning

The day you enroll I start sending EXTRA MONEY JOB SHEETS. You LEARN Radio principles from my easy-to-understand, illustrated lessons—PRACTICE what you learn by building, testing and experimenting with parts I send—USE your knowledge to make EXTRA money fixing neighbors' Radios in spare time while still learning! From here it's a short step to your own full-time Radio Shop or a good Radio job!

### Future for Trained Men is Bright in Radio, Television, Electronics

It's probably easier to get started in Radio now than ever before, because the Radio Repair Business is booming. Trained Radio Technicians also find profitable opportunities in Police, Aviation, Marine Radio, Broadcasting, Radio Manufacturing, Public Address work. Think of even greater opportunities as Television, FM, and many new, war-developed Electronic devices become available to the public! Soon, there will be more Radio equipment to install, operate, maintain and repair than ever before in all history! Get the facts on all these opportunities. Send for FREE books now!

### Find Out What NRI Can Do for You

Mail Coupon for Sample Lesson, "Getting Acquainted with Receiver Servicing," and my FREE 64-page book. It's packed with facts about Radio's opportunities for you. Read the details about my Course. Read letters from men I trained, telling what they are doing, earning. See how quickly, easily you can get started. No obligation! Just MAIL COUPON NOW in an envelope or paste it on a penny postal. J. E. SMITH, President, Dept. 7BX, National Radio Institute, Pioneer Home Study Radio School, Washington 9, D. C.

### I Trained These Men

### SPARE TIME RADIO BUSINESS



"I have a spare time Radio and Electrical business of my own which has been very profitable, due to the efficient training I received from your Course. Last year I averaged over \$50 a month."  
—FRED H. GRIFFIE, Route 3, Newville, Pa.

"I am doing radio work in my spare time, and find it a profitable hobby. My extra earnings run about \$10 a week. I certainly am glad I took your N.R.I. Course."  
—FERDINAND ZIRBEL, Chasoley, North Dakota.



"About six months after I enrolled I started making extra money in radio. I am a farmer and just work on radios evenings and stormy days. That brought me a profit of \$600 in the last year."  
—BENNIE L. ARENDS, RFD 2, Alexander, Iowa.

### I Trained These Men

### FULL TIME RADIO BUSINESS



"Not long ago I was working 16 hours a day in a filling station at \$10 a week. Now I have my own radio business and average over \$60 a week. The N.R.I. course is fine."  
—ALBERT C. CHRISTENSEN, 118 10th Avenue, Sidney, Neb.

"Previous to enrolling for your radio training I made \$12 per week in a hardware store. Now I operate my own repair shop, and often clear \$35 to \$45 a week."  
—FREDERICK BELL, 76 Golf Ave., St. Johns, Newfoundland.



"Am making over \$50 a week profit from my own shop. Have another N.R.I. graduate working for me. I like to hire N.R.I. men because they know radio."  
—NOB MILLER, Hebron, Neb.

## SAMPLE LESSON FREE

I will send you a FREE Lesson, "Getting Acquainted with Receiver Servicing," to show you how practical it is to train for Radio at home in spare time. It's a valuable lesson. Study it—keep it—use it—without obligation! Tells how Superheterodyne Circuits work, gives hints on Receiver Servicing, Locating Defects, Repair of Loudspeaker, I. F. Transformer, Gang Tuning, Condenser, etc. 31 illustrations.



My Radio Course Includes  
**TELEVISION • ELECTRONICS  
FREQUENCY MODULATION**

## GOOD FOR BOTH 64 PAGE BOOK SAMPLE LESSON FREE

J. E. SMITH, President, Dept. 7BX  
National Radio Institute, Washington 9, D. C.

Without obligating me, mail your Sample Lesson and 64-page book, FREE. I am particularly interested in the branch of Radio checked below. (No salesman will call. Please write plainly.)

- |   |  |
|---|--|
| <input type="checkbox"/> My own Radio Service Business                  | <input type="checkbox"/> Operating Broadcasting Station      |
| <input type="checkbox"/> Spare Time Radio Servicing                     | <input type="checkbox"/> Industrial Electronics              |
| <input type="checkbox"/> Service Technician for Radio Stores or Factory | <input type="checkbox"/> Public Address Systems              |
| <input type="checkbox"/> Aviation Radio                                 | <input type="checkbox"/> Ship, Harbor, Gov't. Military Radio |
- (If you have not decided which branch you prefer—mail coupon for facts to help you decide.)

Name..... Age.....

Address.....

City..... Zone..... State.....

**Approved for Training Under GI Bill**





National Union Announces an  
**EXCLUSIVE RADIO  
 MERCHANDISING  
 PLAN** for Service Engineers



HERE IT IS AT LAST! The radio line thousands of service engineers have been waiting for—yes, the radio that has *everything* the service trade needs to cash-in on today's big pent-up new set demand.

And who else but National Union could provide a merchandising plan for radio sets—so perfectly fitted to the service engineer's special needs?

For over 15 years National Union products, plans and policies have been shaped for the exclusive benefit of service dealers.

And now N.U. RADIO SETS are here—for the same service men who have so long known and used other N.U. products—and have found the N.U. way-of doing business a better, more profitable one for their special type of operations.

**THE LINE**—5 models, of which one 5-tube and one 6-tube model are now ready; three others available in 90 days.

**THE PRODUCT**—Top quality throughout; precision-built chassis; beautiful cabinets in modern designs.

**PERFORMANCE**—Thoroughly up-to-the-minute; N.U. sets compare with the best in their class.

**PRICES**—Competitive with established brands.

**VOLUME REQUIREMENTS**—None! N.U. sets are not sold on a franchise basis. Order whatever quantity you need.

**DISTRIBUTION**—Sold only through N.U. Distributors and Service Dealers.



**PRESENTATION MODEL No. G619.** 6 Tubes. AC-DC. Tuned R.F. Stage. Superheterodyne Circuit. Loop Aerial. Automatic Volume Control. Illuminated Slide-Rule Dial. Standard American Broadcasts. Mahogany Veneer All-Wood Table Cabinet, 13" x 8 $\frac{3}{4}$ " x 6 $\frac{1}{2}$ ".



**COMPANION MODEL No. 571.** 5 Tubes. AC-DC. Superheterodyne Circuit. Built-in Antenna. Automatic Volume Control. 2-Gang Air Condenser Tuning. Illuminated Slide-Rule Dial. Standard American Broadcasts. Walnut Veneer All-Wood Table Cabinet, 13 $\frac{1}{2}$ " x 7 $\frac{1}{8}$ " x 8 $\frac{1}{4}$ ".

**OTHER MODELS NOW BEING PLANNED**

- A 3-Way (AC-DC-Battery) Portable Model.
- A Combination Table Model Radio-Phonograph with Automatic Record Changer.
- A 6-Tube Battery-Powered Farm Radio Table Model.

Here, for the first time, is a practical post-war radio line for the service engineer to handle—a group of fine modern radio sets—but *above all* a proven merchandising plan which *fits*. Ask your N.U. Distributor for the complete facts today!

NATIONAL UNION RADIO CORPORATION, NEWARK 2, N. J.

**NATIONAL UNION  
 RADIOS, TUBES AND PARTS**

Transmitting, Cathode Ray, Receiving, Special Purpose Tubes • Condensers • Volume Controls • Phototubes  
 Panel Lamps • Flashlight Bulbs • Radio Sets • Auto Vibrators • Ballasts • Batteries



# New! Exclusive!

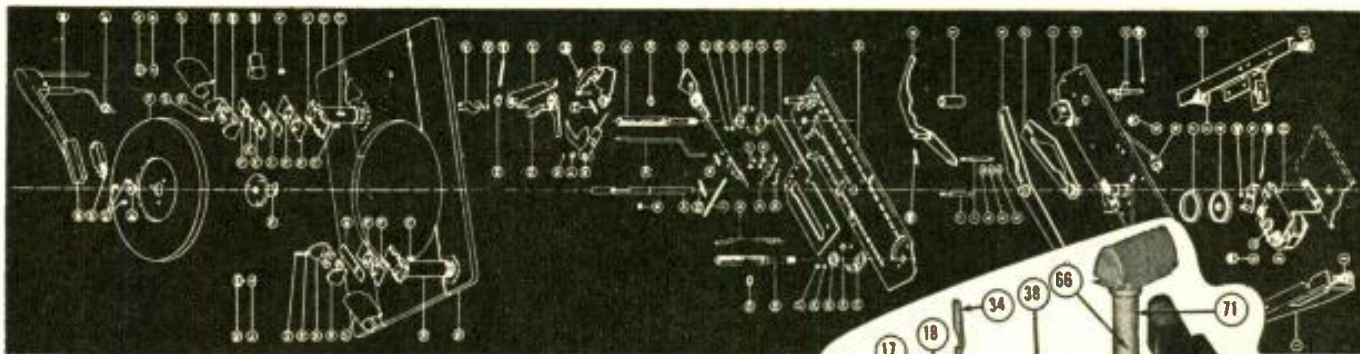

## PHOTOFACT<sup>\*</sup> FOLDERS analyze all post-war RECORD CHANGERS!

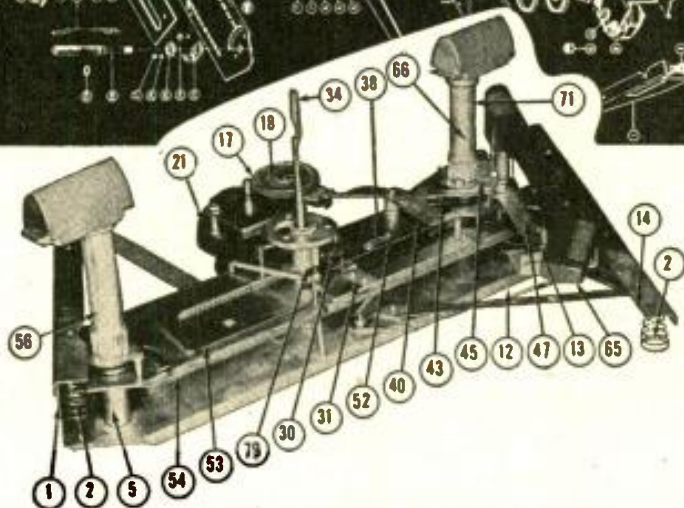

Post-war radio is barely a year old, but already there are 40 different record changers on the market. Do you know who makes them? How they operate? How to service them in case of breakdown? Do you know where you can get up-to-the-minute results of life tests that are now being run?

This vital information now becomes a regular PHOTOFACT FOLDER Service at no Extra Cost to You! Clear-cut photographs, exclusive big line drawings, parts lists, operation details, trouble-cause-and-remedy charts, tell you everything you need to know to do a workmanlike job—help you do twice as many repair jobs a day.

PHOTOFACT FOLDERS save valuable time in many other ways. They make it easy to

\*Trade Mark Reg.

diagnose trouble, hunt defective parts, make adequate replacements in all the latest radios, phonographs, record changers, recorders, communication systems and power amplifiers. Data and photographs are made from actual examinations of instruments—not from reprinted or copied information.

The cost? Only \$1.50 for each set of 40 folders. Actually they cost you nothing, for they pay for themselves over and over again in time saved. **Over 25,000 radio service engineers now use and depend upon PHOTOFACT FOLDERS.** Why let service problems stump you? PHOTOFACT FOLDERS help you lick every one of them! See your nearest distributor or use the convenient coupon.

### PUBLICATION DATES:

Set No. 11 . . . . . January 10  
Set No. 12 . . . . . January 25

Cut this out and MAIL IT TO YOUR DISTRIBUTOR. If you do not know his name and address, send it directly to Howard W. Sams & Co., Inc., 2924 East Washington Street, Indianapolis 6, Indiana, and we will see that your nearest distributor gets it. In Canada, write to A. C. SIMMONDS & SONS, 301 King Street East, Toronto, Ontario. Canadian Price, \$1.75.

#### PLEASE PRINT

Send Vol. 2, Set No. 12       Send Vol. 2, Set No. 11

Send me Volume I (including Sets Nos. 1 to 10) with De Luxe Binder, \$18.39. Individual Sets Nos. 1 to 10, \$1.50 each.

Send me a De Luxe Binder (at \$3.39)

My (check) (money order) (cash) for \_\_\_\_\_ is enclosed.  
(If you send cash, be sure to use registered mail.)

Name \_\_\_\_\_

Address \_\_\_\_\_

City \_\_\_\_\_ Zone \_\_\_\_\_ State \_\_\_\_\_

Company Name \_\_\_\_\_

My Distributor's Name \_\_\_\_\_

City \_\_\_\_\_

HOWARD W. **Sams & CO., INC.** RADIO PHOTOFACT SERVICE

In Canada—write to A. C. SIMMONDS & SONS, 301 King Street East, Toronto, Ontario



# I'LL HELP YOU TO EQUIPMENT EVER

**ALFRED A. GHIRARDI**  
the man who has started thousands of students on successful careers by making Radio-Electronics easy to learn.



A FEW NIGHTS OF **THIS** CAN PAVE THE WAY TO A PROSPEROUS FUTURE OF **THIS**

## Ghirardi's COMPLETE BASIC RADIO-ELECTRONIC TRAINING for beginners

for only \$5 (\$5.50 foreign).

No matter what part of **ELECTRONICS-RADIO-TELEVISION** work you plan to enter, a knowledge of basic fundamentals is absolutely essential. Ghirardi's world-famous 972-page **RADIO PHYSICS COURSE** gives exactly the training you need—at a price you can afford to pay! If broken into "course" form and sent as monthly lessons, you'd regard it as a bargain at \$50 or more! Instead, you buy it for only \$5—and you progress as fast as spare reading time permits. Many have completed it in only a few weeks! Actually, this big, 4 lb. book has given more beginners their start in Radio-Electronics than any other book or course!

Ghirardi's **RADIO PHYSICS COURSE** starts your training at the very beginning—with Basic Electricity. Then it takes you step by step through the entire field of **RADIO-ELECTRONICS-TELEVISION** to the most modern developments. Nothing is omitted or condensed. Everything is explained as simply as A-B-C. You can understand every word of it without previous radio training of any kind. Ask any Radio-Electronic man. He'll know the book—because he probably trained from it himself! Get started now in Radio! Get started right! Our

**5-DAY, MONEY-BACK GUARANTEE** is your absolute protection. If you don't like **RADIO PHYSICS COURSE** you don't need to keep it. You cannot lose!

### NO PREVIOUS TRAINING NEEDED

36 Big Courses in One

Here are a few of the things about which **RADIO PHYSICS COURSE** teaches you:

- |                       |                        |
|-----------------------|------------------------|
| Sound, Speech, Music  | Detector & Amplifier   |
| Electron Theory       | Tube Action            |
| Electric Current      | Radio-Frequency        |
| Electric Circuits     | Amplifiers             |
| Resistance            | Superheterodynes       |
| Batteries             | Audio Amplifiers       |
| Electromagnetism      | Power Supplies         |
| Electromag-Induction  | Loud Speakers          |
| Condensers, Coils     | Auto & Aircraft Radio  |
| Alternating Currents  | Aviation Radio         |
| Transformers          | Public Address Systems |
| Filters               | Phototubes, Cathode    |
| Measuring Instruments | Ray Tubes              |
| Radio Waves           | Sound Pictures         |
| Vacuum Tubes          | Television, etc., etc. |

**RADIO PHYSICS COURSE** is more widely used for home study and was more widely used for Signal Corps and Navy wartime training than any other book of its kind.

The Book That Makes It Easy to Learn at Home

### The Fascinating Story of HOW RADIO GREW UP

and of the men who helped it grow.

**NEW!**  
**JUST!**  
**OUT!**

No story of scientific progress is more exciting than this one. None has ever been told in a more interesting way than Donald McNicol's **RADIO'S CONQUEST OF SPACE** now being offered for the first time. It is the story of men—amateurs, tinkerers and famous scientists—who wrenched from the Universe one of its greatest secrets. It tells what they did and how they did it in piecing the gigantic Radio jigsaw puzzle together. **RADIO'S CONQUEST OF SPACE** is not only a book to be read for fun. Equally important, you'll find in it a wealth of background knowledge invaluable to all radio men and experimenters. Contains 347 pages and dozens of illustrations. Only \$4 complete. Use coupon.

## LEARN ELECTRIC MOTOR REPAIR!

Train for Big Pay in Field That Isn't Crowded  
—Just the Thing for Radio Men

There's big money in motor repair work! Prices are good. The field is not crowded. The home appliance repair business is a vast one and motor service is a highly important part of it. **ELECTRIC MOTOR REPAIR** by Robert Rosenberg is the book that will train you easily and quickly—for only \$5 complete!

**ELECTRIC MOTOR REPAIR** explains every detail of motor trouble diagnosing, repair and rewinding. Covers a-c and d-c motors, synchronous motors and generators and BOTH mechanical and electrical control systems. Quick reference guides show exactly how to handle specific jobs.

Based on what can be learned from

this big book alone, you can train yourself quickly for **PROFITABLE** motor repair service. Ideal for beginners. Unexcelled for actual bench use in busy shops. Every type of work is demonstrated **VISUALLY** by more than 900 easily-understood diagrams. Unique Duo-Spiral Binding arrangement divides book into two sections. BOTH text and related pictures can be seen **AT THE SAME TIME**. Lies open flat on the bench while you work. Contains 580 pages. Only \$5 complete.

Send coupon now. Practice from **ELECTRIC MOTOR REPAIR** for 5 full days. Then, if not more than satisfied, return book to us and your money will be cheerfully refunded.

**NEW - DIFFERENT - EASY TO UNDERSTAND**

# GHIRARDI TRAINING TO SAVE YOU LEARN EASIER, BETTER, FASTER...



# REPAIR ANY RADIO-ELECTRONIC

**MADE . . . AND GUARANTEE TO REFUND EVERY CENT OF YOUR MONEY IN FIVE DAYS IF YOU'RE NOT SATISFIED!**

## THIS 4½ LB. HANDBOOK SHOWS EXACTLY HOW TO REPAIR OVER 4,800 RECEIVER MODELS

*A Definite, Dependable Guide for Diagnosing, Locating and Repairing the Common Troubles in Almost Every Receiver Ever Made*  
**GHIRARDI TELLS YOU WHAT TO DO—EXACTLY HOW TO DO IT**

Whether you repair radios for a living or work with them only occasionally, Ghirardi's **RADIO TROUBLESHOOTER'S HANDBOOK** will help you do the jobs better AND TWICE AS FAST. Eliminates useless testing! Saves time—helps you make more money! When a receiver comes in for repairs, simply turn to the 404-page Case History section. Look up the notes on that make and model. Chances are you'll find EXACTLY the information you require. The Handbook tells what the trouble is—how to remedy it. Ideal for training and speeding up the work of new service helpers—handling tough jobs in half the usual time—repairing cheap sets rapidly.

### NOT A "STUDY" BOOK

The tabulations on hundreds of additional pages give you invaluable data on Color Codes, Tubes, I-F alignment and transformer troubles, tube substitutions, etc., and the literally dozens of charts, graphs, diagrams, data and helpful hints will save you money every day you use them!

"Thanks to Ghirardi's Handbook, I repaired my

radio in one hour after it had been returned as 'unrepairable' from a local shop," writes J. L. Fizzell, Kansas City, Mo.

"I would not take ten times the price my Handbook cost me," says C. E. Daniels of Florida.

"Started to work for me the first day I bought it. The Case Histories take you right to the trouble and save headaches and hours of testing," says Julius Siske, Jr., Curtis Bay, Maryland.

Ghirardi's big Handbook weighs 4½ lbs., contains 744 big manual-size pages. Only \$5 complete—on our 5-Day Money-Back Guarantee offer!

### STOP GUESSING MISTER!

Don't guess! Don't waste time! Turn to Ghirardi's big Radio Troubleshooter's Handbook—let it tell you in a jiffy WHAT to do and HOW to do it.



Only \$5 complete (see money-saving offer in coupon)

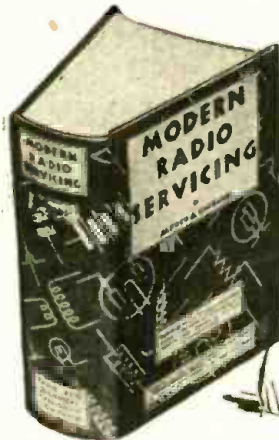

## GET A COMPLETE MODERN Professional SERVICE TRAINING . . . at Home Without an Instructor

Now, as never before, the call is for PROFESSIONALLY TRAINED men who really KNOW radio repair work.

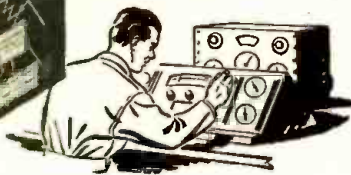

Only \$5 complete (See money-saving offer in coupon)

A. A. Ghirardi's MODERN RADIO SERVICING is the finest, most complete instruction book on Radio-Electronic service work for either the novice or the professional serviceman—bar none! Actually, it gives a COMPLETE MODERN EDUCATION in truly professional service work of the kind that will be your "Open Sesame!" to the real opportunities in Radio-Electronic servicing springing up on every side. Remember! The call is now for HIGHLY TRAINED men having a broad knowledge of modern test equipment and testing techniques—NOT for "screw-driver" mechanics of limited technical understanding!

Read from the beginning, MODERN

RADIO SERVICING is a complete servicing course from A to Z. Used for reference, it is an invaluable refresher course on any type of work that puzzles you. Explains all types of test instruments used in Radio-Electronic service work—also how, when, why and where to use each one; how to make preliminary trouble checks and perform circuit analysis; how to repair or replace parts or make substitutions—and literally hundreds of additional subjects, including How to Start and Operate a Successful Service Business of Your Own. 1300 pages, 706 clear illustrations, 720 self-test review questions.

## START A SERVICE BUSINESS . . . OR, GET A BETTER-PAYING JOB!

There's a real future for you in servicing—and A. A. Ghirardi's MODERN RADIO SERVICING is just the book to start you on it without delay. And remember: Radio itself only represents the beginning of this big book's usefulness to you. What it teaches you about Radio Servicing, Test Instruments and Modern Scientific Technical Procedure is exactly the training you need to fit you to "grow up" with the fast-expanding Electronics profession in all of its servicing phases.

The amount of Radio and Electronic equipment that will be manufactured and sold both to industry and the public within the next few years will be tremendous. All of it must be serviced—and there'll be rich rewards for competently trained men who can fill the bill!

MODERN RADIO SERVICING gives you real Professional service training—complete in every respect—easy to understand—and priced at only \$5 complete!

## FIVE DAY UNRESTRICTED MONEY BACK GUARANTEE

**MURRAY HILL BOOKS, Inc., Dept. RC-27**  
**232 Madison Ave., New York 16, N. Y.**

Enclosed find \$\_\_\_\_\_ for books checked; or,  send C. O. D. (in U.S.A. only) for this amount plus postage. In either event, I may return the books for refund of my money within 5 days if not fully satisfied.

RADIO PHYSICS COURSE \$5 (\$5.50 foreign)

MODERN RADIO SERVICING \$5 (\$5.50 foreign)

MONEY-SAVING COMBINATION OFFER: Modern Radio Servicing and Troubleshooter's Handbook—both big books—\$9.50 (\$10.50 foreign)

RADIO TROUBLESHOOTER'S HANDBOOK, \$5 (\$5.50 foreign)

ELECTRIC MOTOR REPAIR \$5 (\$5.50 foreign)

RADIO'S CONQUEST OF SPACE \$1 (\$1.35 foreign)

Name \_\_\_\_\_  
 Address \_\_\_\_\_  
 City & Dist. No. \_\_\_\_\_ State \_\_\_\_\_

**TIME & MONEY**  
 Mail coupon now!



## MONEY-SAVING COMBINATION

Make your servicing library complete! Get BOTH Ghirardi's RADIO TROUBLESHOOTER'S HANDBOOK and MODERN RADIO SERVICING at the special Money Saving Combination price of only \$9.50 for the two (\$10.50 foreign). Use coupon today!



**WHATEVER YOU NEED IN RADIO OR ELECTRONICS**

**PARTS...SETS...KITS  
TESTING EQUIPMENT...TOOLS  
PUBLIC ADDRESS EQUIPMENT  
TRANSMITTERS**

**YOU CAN GET IT AT NEWARK!**



**SERVICEMEN**

Three big stores, each carrying tremendous stocks, are ready to serve you with tools, replacement parts, test equipment, sets or anything else you need. Wire, write or telephone if you can't visit one of our stores. If you can visit with us you'll find our trained staff of tremendous help to you.

**SERVICE**

Mail orders are shipped the same day they are received. You don't have to wait when you buy from Newark. On special inquiries, we give you full information, prices and delivery dates promptly. Newark will give you service that will help you serve your customers better.

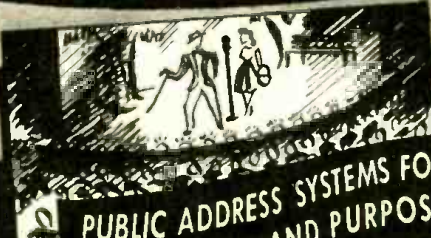

**PUBLIC ADDRESS SYSTEMS FOR EVERY NEED AND PURPOSE**

No matter what your public address needs may be, Newark has the outfit that will do the job for you. All the well known, standard makes are carried in stock. Delivery is fast and dependable . . . in New York and Chicago we maintain our own delivery system . . . for out-of-town customers we ship orders the same day they are received.

All our stores are staffed by trained men who know public address needs and can help you select the outfit that will best serve your purpose. If your needs are unusual, they know how to make up special combinations to satisfy them efficiently.

If you can, visit one of our stores. If you can't come to see us, write, phone or telegraph and your inquiry will be answered promptly and fully. Newark has the stock, Newark has the 'know how', Newark can help you.



**BUILD YOUR OWN RADIO AND ELECTRONICS DEVICES AT LOW COST**

With Newark's kits and parts you can easily build radio receivers, transmitters, amplifiers, and other exciting radio and electronics devices.

Make a good radio receiver for yourself or a fine record player with automatic changer at tremendous savings. You can construct these and many other radio and electronics devices easily. Our men know how to make them and will gladly show you if you can visit one of our stores—or will explain clearly by mail.

**FOR GOOD BUYS AND A GOOD TIME  
VISIT OUR BIG BARGAIN COUNTERS**

These big bargain counters in all our stores, are loaded down with special items available in quantities too small to advertise. Marvelous war-time sets, new small gadgets you can have fun with . . . all sorts of new parts and special things you'll want to see. Come in, look around and ask all the questions you wish. Come in often you'll have a wonderful time.

**WRITE FOR OUR BIG BARGAIN BULLETIN  
LISTING THE LATEST AVAILABLE EQUIPMENT**

MAIL ORDERS FILLED FROM EITHER N. Y. OR CHICAGO

Magazines are printed months before you read them, stocks change, new things are developed and made, so we give you the very latest news about the very newest things in radio and electronics in our Big Bargain Bulletin. Send for your copy today and know all about the latest equipment first. When writing address Dept. F-4



N.Y.C. Stores: 115 W. 45th St. & 212 Fulton St. Offices & Warehouse: 242 W. 55th St. N.Y. 19



# SYLVANIA NEWS

## RADIO SERVICE EDITION

FEB.

Prepared by SYLVANIA ELECTRIC PRODUCTS INC., Emporium, Pa.

1947

# ONE DEVICE NOW USED BY RADIO SERVICEMEN FOR GREAT VARIETY OF TESTS

## Electrical Measurements Made Easy With New Sylvania Unit!

### The SYLVANIA Poly (MULTI-PURPOSE) Meter

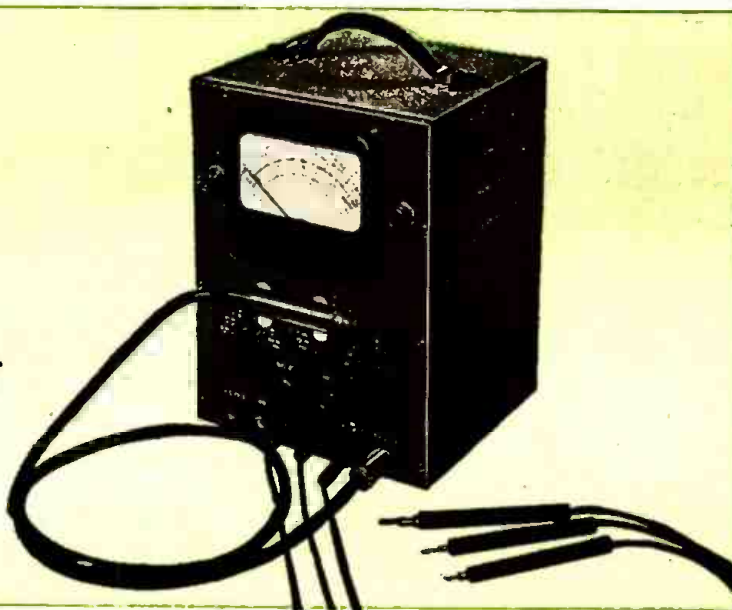

Radio servicemen now can use the new Sylvania Poly (MULTI-PURPOSE) Meter type 134 to facilitate a multitude of electronic measurements and tests.

This product of Sylvania Research is stabilized against errors due to voltage variations or gas current in tubes. All accessories included. See your Sylvania Distributor.

#### CHARACTERISTICS AND SPECIAL FEATURES

Tests audio, A.C. and R.F. voltages from 20 cps to 300 mc through use of proximity fuze-type tube built into handy probe. Full scale range of 3, 10, 30, 100, 300.

Measures D.C. from .1 to 1,000 volts in full scale ranges of 3, 10, 30, 100, 300, 1,000.

Measures D.C. current from .1 milliamperes to 10 amperes in full scale ranges of 3, 10, 30, 100, 300, 1,000 milliamperes and 10 amperes.

Measures resistance from  $\frac{1}{2}$  ohm to 1,000 megohms in full scale ranges of 1,000, 10,000, 100,000 ohms and 1, 10, 1,000 megohms.

#### ACCURACY

D.C. ranges  $\pm 3\%$  of full scale.

A.C. ranges  $\pm 5\%$  of full scale up to 30 volts and  $\pm 7\%$  above 30 volts.

R.F. ranges  $\pm 5\%$  of full scale up to 10 volts;  $\pm 7\%$  from 10-100 volts;  $\pm 10\%$  on 300 volt range.

Ohms  $\pm 6\%$  to the left of  $\frac{1}{2}$  scale;  $\pm 13\%$  to the left of  $\frac{3}{4}$  scale.

Current  $\pm 3\%$  of full scale on all but 10 ampere scale which provides  $\pm 5\%$  of full scale.

#### INPUT IMPEDANCES

R.F. ranges—2.7 megohms resistance shunted by approximately 3 mmf. capacity.

A.C. ranges—2.7 megohms resistance shunted by approximately 40 mmf. capacity.

D.C. ranges—16 megohms resistance.

Remember the Sylvania Poly (MULTI-PURPOSE) Meter type 134 is beautifully styled, compactly designed and easily read.

# SYLVANIA ELECTRIC

Emporium, Pa.

MAKERS OF RADIO TUBES, CATHODE RAY TUBES, ELECTRONIC DEVICES, FLUORESCENT LAMPS, FIXTURES, WIRING DEVICES, SECURITY LIGHT BULBS



# HERSHEL'S MONEY SAVING VALUES

on Radio and Electronic Equipment

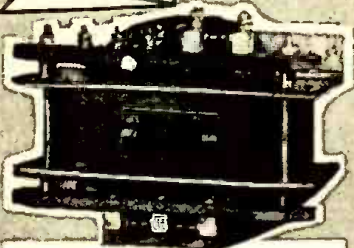

### 1 KW. MODULATION TRANS.

We have a real value in a modulation transformer. This item, made by RCA to broadcast specifications, is conservatively rated at 550 W audio to modulate that new KW rig. Primary impedance for class B tubes up to 10,000 ohms plate to plate, secondary rated at 450 MA, 1:1 Ratio. Third winding modulates screens up to 80 MA current.

Really rugged construction, with flash-over gaps on a Mycalex terminal board. Due to the fine lamination, this transformer will not talk back at 1 KW. Weight 40 lbs. **\$19.95**



Tuning unit BC 375. Approx. 65 MMFD cond., coils, RF chokes, dials, astid. mica condensers 2500 WVDC, over \$50.00 in parts. **\$3.75**

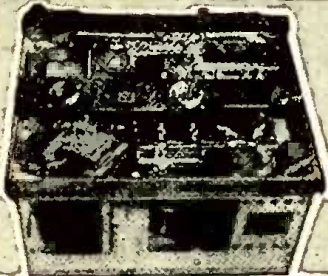

SCR 522-100-156 MC receiver and transmitter with 18 tubes.

Price New **\$59.95**  
Price Used **\$39.95**



Dynamotor power supply—inputs 6 or 12 V, output 500 VDC at 160 MA, mounted on box with circuit breakers, relays, interference filter and two 10 ft. cables. U. S. Govt. surplus. **\$9.95**



30 MC IF transformer in square aluminum can, silver slugged tuned. **29c**

Mica capacitor .002 MFD 3000 WVDC **89c**



### 1000 V PLATE SUPPLY

Thoradson plate transformer T47105. 1185 V each side of center at 300 MA. Tapped at 300 V each side of center, also 215 V at 55 MA bias. 6" x 5" x 7 1/2" in square gray, CMT two case. **\$9.95**



Thoradson T48003 2H-7H 550 MA rwing choke, size 4 1/2" x 3 1/2" x 3 1/2", square black crackle case. **\$5.95**



Hi-voltage condenser, 3 MFD, 4000 V, hermetically sealed in aluminum can. **\$4.95**

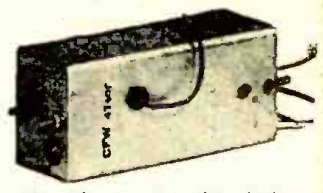

IF transformer, mounted in aluminum shield can, 1500 KC, with air trimmer, impedance coupled type. **95c**



Westinghouse meter, 0-1 MA movement, 2" round case, scale calibrated 0-140 and 0-500. Includes mounting hardware. **\$2.95**

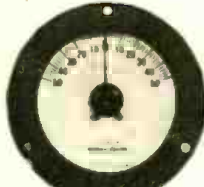

Western Electric meter, 4" round, zero center, 0-1/2 MA each side. **\$3.95**



Westinghouse meter, 0-1 RF amps, 2" round case, internal thermocouple, in original box. Includes mounting hardware. **\$2.95**

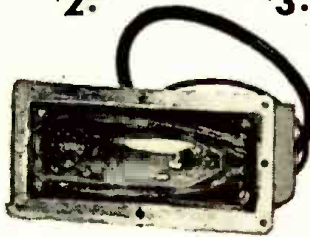

### PHOTO FLASH TUBE

High speed photo flash tube, 12,000,000 lumens light output. Stops all action. Ignition coil included on back of bulb. 10,000 flashes. Diagrams furnished on request. Your cost only. **\$8.95**

### SELSYN MOTORS

The ideal way of indicating the position of rotary beams, wind indicator, etc. Line cord and instructions for 110 VAC operation furnished.

2 for **\$3.95**



### R. L. T. TUBE TESTER

- Tests all tubes up to 117 V
- Tests shorts and leakages
- Tests individual sections
- Works on 90-125 V 60 cycle AC
- Comes in portable cabinet complete with all operating instructions.

PRICED AT ONLY

**\$49.95**

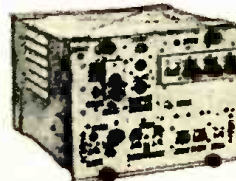

Transmitter and Receiver. Has been widely used on the 144 MC band. Shipping wt. 100 lbs. U. S. Govt. surplus. Your price, less tubes and power transformer. **\$14.95**

## Hot Spot Specials

- Thoradson fl. trans., 110 V 60 cycle pri., two 10 V 10 A sec., CMT type **\$4.95**
- Thoradson fl. trans., 110 V 60 cycle pri., sec. No. 1 2.5 V 10A CT, 3000 V int., sec. No. 2 10 V 3.25 A; two 5 V 3 A; 6.3 V 1 A. **\$1.49**
- Thoradson fl. trans., pri. 110 V 60 cycle; sec. 6.3 V 6 A, CT. **69c**
- 8-8 MFD 350 WVDC, 20 MFD 150 WVDC, round can. **49c**
- 75,000 ohm 200 W bleeder. **49c**
- 2500 ohm 100 W adj. **65c**
- 955-9004 tubes. **24c**
- Sockets for acorn tubes. **95c**
- 6JA.....\$1.50 **61c**
- Lip mike and head band. **95c**
- No. 60 A—6F6-5 General Universal A & B battery, 7.5 V 9V 90 V B. **\$1.49**



368AS-tube. A real buy in a VHF door knob tube that will take 30 W input on all frequencies up to 1500 MC. No socket required. Priced at small fraction of original cost. **\$4.95**

Write for Free Bulletin

# HERSHEL RADIO CO.

5249 GRAND RIVER

DETROIT 8, MICHIGAN

20% DEPOSIT REQUIRED ON ALL C. O. D. ORDERS



# NOW SPRAYBERRY RADIO TRAINING

## GIVES YOU 8 BIG KITS OF RADIO EQUIPMENT



WITH A **COMPLETE 6 TUBE SUPER-HETERODYNE RECEIVER**

**YOU LEARN RADIO SERVICING**  
THROUGH INTENSIVE "SHOP-BENCH" PRACTICE

### YOU DO EXPERIMENTS, CONSTRUCTION, TROUBLE-SHOOTING

I'll show you how to perform over 175 instructive Experiments—how to build countless Radio Circuits. You'll learn a new, fast way to test Radio Sets without mfg. Equipment.



I give you a fine, moving-coil type Meter Instrument on Jewel Bearings—with parts for a complete Analyzer Circuit Continuity Tester. You learn how to check and correct Receiver defects with professional accuracy and speed.

You'll get valuable experience and practice building this Signal Generator and multi-purpose Tester. Makes a breeze out of fixing Radios and you don't have to spend money on outside, ready-made equipment.



Soldering, wiring, connecting Radio parts . . . building circuits with your own hands—you can't beat this method of learning. When you construct this Rectifier and Filter, Resistor and Condenser Tester, etc., you get a really practical slant on Radio that leads to a money-making future.

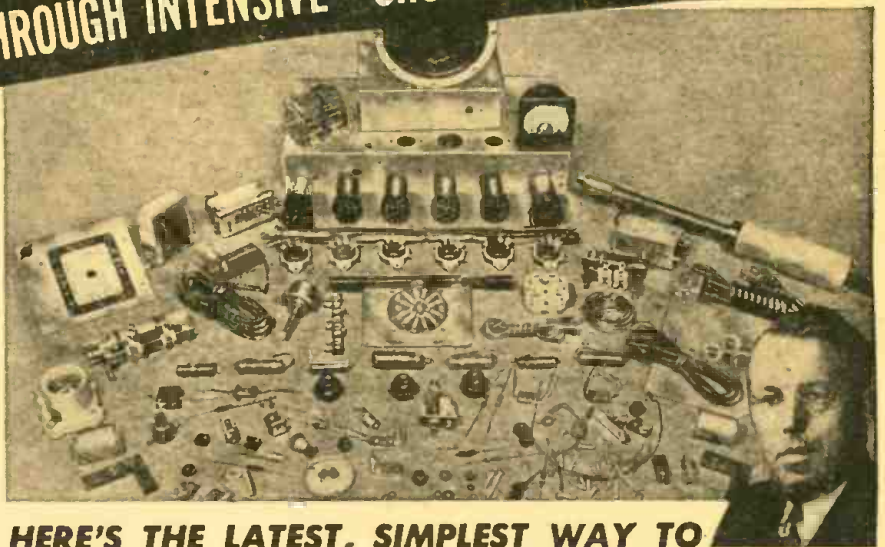

### HERE'S THE LATEST, SIMPLEST WAY TO TRAIN at HOME for a GOOD LIVING in RADIO-ELECTRONICS & TELEVISION

I train your mind by putting you to work with your hands on a big 6-Tube Superheterodyne Receiver. And, believe me, when you get busy with real Radio Parts—8 big Kits of them—you really LEARN Radio and learn it RIGHT! You get the practical stuff you need to be useful in Radio, and that's what it takes to make money. You don't have to worry about what to do with these 8 Kits of Parts. Step by step, I show you how to build circuits, test, experiment, trouble-shoot. And you don't need any previous experience. The Sprayberry Course starts right at the beginning of Radio! You can't get lost! Simplified lessons, coupled

with real "Shop" practice, makes every subject plain and easy to understand and remember.

#### A BUSINESS OF YOUR OWN . . . OR A GOOD RADIO JOB

Soon after you begin Sprayberry Training, I'll send you my sensational **BUSINESS BUILDERS**. You'll find out how to get and do neighborhood Radio repair jobs for nice profits and rich experience while learning. This sort of work can easily pave the way for a Radio Service business of your own. But with Sprayberry Training, you're not limited. You can swing into any one of the swiftly expanding branches of Radio-Electronics INCLUDING Radio, Television, FM, Radar, Industrial Electronics. Be wise! Decide now to become a fully qualified **RADIO-ELECTRONICIAN**. Get full details about my Training at once! Mail coupon below for my 2 big FREE Books.

### SEND FOR THESE FREE BOOKS



"How to Read Radio Diagrams and Symbols"

Here's a valuable and wonderfully complete new book which explains in simple English how to read and understand any Radio Set Diagram. Includes translation of all Radio symbols. Send for this volume at once! It's free! Along with it, I will send you another Big Free book describing in detail my Radio-Electronic Training.

#### SPRAYBERRY ACADEMY OF RADIO

F. L. Sprayberry, President, Room 2027, Pueblo, Colorado

Please rush my FREE copies of "How to MAKE MONEY in RADIO, ELECTRONICS and TELEVISION," and "HOW to READ RADIO DIAGRAMS and SYMBOLS."

Name ..... Age .....

Address .....

City ..... State .....

(Mail in envelope or paste on penny postcard)

**MAIL COUPON TODAY!**



# FEBRUARY • 1947

Editorial: Radio Progress is Slow .....	by Hugo Gernsback	17
Radio-Electronics Monthly Review .....		18, 19
The Radio Pen in Europe .....		71

## Electronics

High Speed Photo Flash .....	by Lyman E. Greenlee	22
Teleguided Missiles .....	by James A. Niland	24
Television for Today, Part IX—D.C. Reinsertion and Image Synchronization .....	by Milton S. Kiver	31
Antenna Principles, Part III—Directional Arrays and Radiation Fields .....	by I. Queen, W2OUX	33
Radio Frequency Lamp .....		46

## Amateur Radio

250-300 Mc Radiophone (Cover Story) .....	by R. F. Scott, W2PWG	20
Simple Frequency Monitor .....	by I. Queen, W2OUX	21
Ham Station from Surplus .....	by Merrill Lindley	30

## Servicing

Problems of Instability .....	by Ted Powell	25
Radio Data Sheet 344 (National Union Model G-619) .....		34
The Probe Tracer .....	by Hubert L. Bailey	45
Transformer Winder .....		48

## Sound

Small Recording Studio, Part I—Microphone, Recorder, Turntable and Pickup .....	by J. C. Hoadley	26
Sound Engineering—No. 27 .....	Conducted by A. C. Shaney	36

## Construction

Building a Televiser, Part II—The Sound Section Is a Good FM Receiver .....	by Roy Freeland	28
Simple Modulation Meter .....	by A. B. Kaufman	32
Detector for the Oscilloscope .....	Kenneth C. Dike	74

## Departments

Transatlantic News .....	by Major Ralph W. Hallows	35
World-Wide Station List .....	Edited by Elmer R. Fuller	37
Radio-Electronic Circuits .....		38
Try This One .....		40
Why Not? .....		44
The Question Box .....		50
Technotes .....		54
New Radio-Electronic Patents .....	by I. Queen	70
Communications .....		76
Book Reviews .....		79

# RADIO CRAFT

AND POPULAR ELECTRONICS

Incorporating  
SHORT WAVE CRAFT TELEVISION NEWS  
RADIO & TELEVISION

## HUGO GERNSBACK

Editor-in-Chief

## FRED SHUNAMAN

Managing Editor

## M. HARVEY GERNSBACK

Consulting Editor

## ROBERT F. SCOTT, W2PWG

Technical Editor

## I. QUEEN, W2OUX

Editorial Associate

## ELMER FULLER

Shortwave Editor

## ANGIE PASCALE

Production Manager

## G. ALIQUO

Circulation Manager

## JOHN J. LAMSON

Advertising Director

## ALFRED STERN

Promotion Manager

## On THE COVER:



Directional Radiophone built by the Japanese in imitation of American amateur equipment.



RADCRAFT PUBLICATIONS, INC. Hugo Gernsback, President; M. Harvey Gernsback, Vice President; G. Aliquo, Secretary

Contents Copyright, 1947, by Radcraft Publications, Inc. Text and illustrations must not be reproduced without permission of Copyright owners.

RADCRAFT PUBLICATIONS, INC. • PUBLICATION OFFICE 29 Worthington Street, Springfield 3, Mass. • EDITORIAL AND ADVERTISING OFFICES 25 West Broadway, New York 7, N. Y. Telephone REctor 2-9690.

BRANCH ADVERTISING OFFICES: Chicago: 308 W. Washington Street, Suite 1413, Chicago 6, Ill. Tel. Randolph 7363. Cleveland: Burdette Phillips, Manager, 405 Erie Bldg., Cleveland, Ohio. Tel. Main 9645. Detroit: Frank Holstein, Manager, 307-8 Boulevard Bldg., Detroit, Mich. Los Angeles: Ralph W. Harker, Manager, 606 South Hill St., Los Angeles 14, Calif. Tel. Tucker 1793. San Francisco: Ralph W. Harker, Manager, 582 Market St., San Francisco 4, Calif. Tel. Garfield 2481.

RADIO-CRAFT, February, 1947, Volume XVIII, No. 5. Published Monthly on 28th of month preceding date of issue. Allow one month for change of address. When ordering a change, please furnish an address stencil impression from a recent wrapper. All communications about subscriptions should be addressed to the Circulation Manager, Radio-Craft, 25 West Broadway, New York 7, N. Y.

SUBSCRIPTION RATES: United States and possessions, Mexico, Central and South American countries, \$2.50 a year; \$4.00 for two years; \$6.00 for three years. Canada, 3.00 a year; \$5.00 for two years; \$7.50 for three years. All other foreign countries, \$3.25 a year; \$5.50 for two years; \$8.25 for three years. Special rates for members of the Armed Forces in U.S., or those addressed by A.P.O. or F.P.O. mail, \$2.00. Entered at Post Office, Springfield, Mass., as second-class matter under the Act of March 3, 1879.

FOREIGN AGENTS: Great Britain: Atlas Publishing and Distributing Co., Ltd., 18 Bride Lane, Fleet St., London E.C.4. Australia: McGill's Agency, 179 Elizabeth Street, Melbourne. France: Brentano's, 37 Avenue de l'Opera, Paris 2e. Holland: Technisch Bureau Van Baerle, Bemelmans & Co., Heemsteedsche, Dreef 124, Heemstede. Greece: International Book & News Agency, 17 Amerikis Street, Athens. So. Africa: Central News Agency, Ltd., 369 Smith Street, Durban, Natal. Universal Book Agency, 70 Harrison Street, Johannesburg. Middle East: Steimatzky Middle East Agency, Jaffa Road, Jerusalem. India: Magazines Distributors, 5 Bombay Mutual Annexe, Gunbow Street, Fort, Bombay 1.



# Selected as one of the Nation's Foremost

**RADIO-ELECTRONICS** courses  
of DeForest's Training, Inc.  
recommended by the New  
York Museum of Science  
and Industry

DeForest's Training Inc. wins Museum's Certificate of Merit for Home  
Study and Residence courses... First school of its kind to be so honored

**ELLERY L. PLOTTS**  
Nationally Known Radio  
Station Consulting Engineer



## Nationally Known Radio Engineer Endorses DeForest's Training, Inc.

"The Home Study course of DeForest's Training, Inc., is a short cut to the fascinating and profitable field of Radio and Electronics," says Ellery L. Plotts, nationally known radio station consulting engineer and former special research associate at Harvard University's Radio Research Laboratories.

"Now is the time . . . to prepare to enter the field of Radio and Electronics . . . No greater opportunity is afforded the high school student . . . the war veteran . . . or the man who wants to make more money," says Ellery L. Plotts, nationally known radio station consulting engineer and former special research associate at Harvard University's Radio Research Laboratories.

"Investigation reveals that these DeForest's Training, Inc., courses are as modern as they are thorough. Each home study student has the use of a motion picture projector, which gives advantages heretofore unknown in home study training. The comprehensive kits of Radio parts are unusually valuable inasmuch as they enable a man to get practical, on-the-job experience in his own home. Further study enables me to highly recommend either the home study or resident course," says Ellery L. Plotts.



## Enjoy Real Movies at Home

Through the courses of DeForest's Training, Inc., you not only learn-by-doing and reading, but you also have the use of a motion picture projector and 12 reels of film. No other course affords this opportunity to learn important Radio fundamentals faster and easier at home. DeForest's Training, Inc., also includes instruction in Motion Picture Sound Equipment, FM Radio and Television.



## Choose This Selected Course for Radio-Electronic Training

DeForest's Training, Inc., only, gets you off to a brighter future by supplying "ALL 4" of these major training benefits **AT HOME** . . . (1) Learn-By-Seeing Movies, (2) Illustrated Loose-Leaf Lessons, (3) Learn-By-Doing Radio Equipment and (4) Employment Service.

8 Kits of quality Radio parts provide the practical experience you need . . . enabling you to build and operate SEVEN different Radio Receivers, a Radio Telephone, Wireless Microphone, Photo Electric Cell Devices and dozens of other marvels in this Electric Age.

Get the complete facts now and see how quickly YOU may get started toward this field of outstanding opportunity. Mail the coupon today.

## Says Course Is Worth Many Times Cost

"I think the visual training part of your course is 'tops'! I think your course is worth many times more than what you actually charge for it. I truly believe this is the field to get into for any man interested in a real future and the welfare of his family's peace and security."



**HAROLD J. ELLIOTT,**  
701 Miller Avenue., Ann Arbor, Michigan

## WRITE TODAY FOR FREE INFORMATION

DeFOREST'S TRAINING, INC.  
2533-41 N. Ashland Ave., Dept. RC-D2  
Chicago 14, Illinois, U. S. A.

Send me your big book "VICTORY FOR YOU," showing how I may make my start in Radio-Electronics with your modern home training plan. No obligation.

Name..... Age.....

Address..... Apt.....

City..... Zone..... State.....

If under 16, check here for special information.

If a discharged veteran of World War II, check here.



**DeFOREST'S**  
**TRAINING, INC.**  
CHICAGO, ILLINOIS



## RELAYS

- A. DPDT 10a contacts, 115v/60 cps coil. ALLIED \$1.59
- B. SPST 5a, ac; 115v cont. 115v/60 cps. .... \$1.25
- C. SPDT contacts; coil rated 115v/60 ..... 1.39
- D. SPST latching relay made by Kurman. Close coil 115 V/60c; DCR 1500 ohms. Open coil 115 vdc 10 ma; DCR 5000 ohms 2.95
- E. DPST Telephone type; 2p, 1 cl; 1 open; cont. rating, 5a at 50v, coil rating 3.5 ma (at 12K ohms), 1000 vac. .... 1.05
- F. DPDT Steatite insulated 10 amp silvered contacts, made by Leach ..... 1.95
- G. SPDT Struthers-Dunn sensitive keying relay, 5 MA-DC Coil. 110v/60 cycles—2 Amp contacts.. 1.49

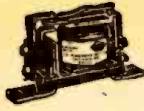

**NEW USN NAVY MODEL RAK-7 SHIP RECEIVER \$69.95**

15 kc to 600 kc. 6-tube receiver with: AVC-Band pass filter-Audio filter—Noise limiter—Precision tuning with a Vernier dial—Voltage regulated power supply, with three tubes, for 60 cycle, 115 volts. Can be battery operated. Complete with spare parts box weighing 73 lbs., tubes and inst. book.

# KILO WATT KOMPONENTS

## RA-58-A Hi-Voltage Power Supply



Ideal for breakdown insulation testing, or as a source of power for a pulse transmitter. This unit supplies continuously variable voltages between 500 and 15,000 volts DC at 35 ma. A voltage Doubler circuit using two 705a rectifiers and two 1 mf condensers is employed. RMS ripple voltage at maximum power is 6%. THIS UNIT OPERATES FROM 115 v/60c. Variable voltage is obtained by means of a Variac in the primary circuit of the high voltage transformer. Size is 21"x17 1/2"x20" deep. Net weight 314 lbs. This unit sells for the low price of **\$116**

## New SCR-274N Transmitters

25-watts CW; 15 watts phone. Tubes (included); 2—1625; 1—1629; 1—1626; 1—6200 Kc. crystal. Range (specify frequency desired); 5—8 mc; 8—1.3 mc; 1.3—2.1 mc; 4—5.3 mc. Power: 24—28 v dc. Remote control with key and plugs. Less dynamotor ..... **\$25.50**

Modulator unit (with tubes) 1—1625; 1—VR-150; 1—12J5 ..... **\$12.00**

Transmitter dynamotor extra ..... **\$16.00**

## New Arc-5 Superhet Receivers



Tubes (included) 3 — 12SK7; 1 — 12K8; 1 — 12SH7; 1 — 12A8. Freq. range: 190 kc - 550 kc. Complete with control box, dynamotor, rack, shock mounts, and all the necessary plugs. Tubes and schematic are included ..... **\$32.50**



**NEW POWER SUPPLY** for LM-18 freq. meter. Output: 290 v @ 20 ma; 13 v @ 600 ma. Input: 105-125 v @ 60 cps; 260 ma; 27.5 W. type 84 rectifier tube; shock mounted. Complete with input and output plugs, tube included ..... **\$14.75**

## SONAR DETECTION UNIT!!

Ideal for detecting underwater sounds, such as fish swimming in schools, within a 15 mile area. Using a Rochelle salt crystal, which is about 1000 times more sensitive than quartz, as the active unit the sound is transmitted up a 60 ft. length of cable. It is completely enclosed in a solid rubber sheath. This sound detector was originally used in harbor defense. Coupled to an audio amplifier, this can be found to have many valuable applications. **\$9.95** Ask for SD-1.

## BC-610 TUNING UNITS \$4.95

We have just received a limited supply of Tuning Units for the BC-610. They are all in NEW or very good condition. When ordering specify frequency range.

## TRANSMITTING CONDENSERS



Cardwell Split-Statator type PK-200-QD. 200-30 mmf per section. Special Hi-Volt with 2" spacing \$9.95 Johnson type 500D35. 500-35 mmf .08" spacing. (Listed at 11.75) .. **\$4.75**

## SPECIAL ITEMS

- Tube shields for 2AP1 ..... .98
- Transmitting key; 200 watt. .... .79
- Hook-up wire, stranded, 100 ft. .95
- Mycalox strips, 1/4"x3"x14 1/2", ea. .10
- 12 for \$1.00. Minimum order. .60
- Hand generator type GN-45B. Output: 6v-3a/500v-14a. rated speed 60 cps. .... 5.95
- Antenna loading coil, Heavy duty, with six (6) variable taps. 6 3/4" long x 4 3/4" dia. .... 2.95
- Visor for 5" scopes ..... .75
- Broadcast band push-button tuning units. Inductive and capacitive type ..... 1.98
- Matched pair precision resistors, 6.33 megs. .... 1.50
- Completely punched chassis for 2-inch scope, with some sockets 1.50

## SILVER BUTTON MICA CONDENSERS

stud. mtc. (Erie/Centralab.) 175-180-185 mmf 400 vdc, each 05 400 and 500 mmf each. .... 10c

## SELSYN MOTORS

115 vac (60 cps) size 5G. New! Ideal for remote control, or for antenna rotation. **\$7.75**

## TRANSFORMERS

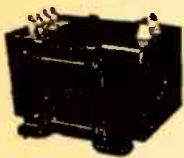

**AMERTRAN PLATE TRANSFORMER!** 115 v-60 cycle primary. 6200 volt-ct-700 mil secondary. Size 11"x14"x10". \$39.95

**1/2 WAVE RECTIFICATION TRANSFORMER** 115v-60c/3200v @ 150 mls. MADE BY KENYON ..... **\$7.25**

## CHOKES

- 12hy-12 hy @ 150 ma., 15 amp. rating, each price ..... **\$4.25**
- 15 hy @ 165 ma 200 ohms DCR made by Jefferson. Price ..... 2.00
- 59 hy @ 100 ma 850 ohms DCR made by Jefferson. Price ..... 2.00
- 2.6 hy @ 800 ma stud and terminals at bottom ..... 5.95

## AUDIO TRANSFORMER, MODULATORS, ETC.

- Modulation xfmr: typical for 211's cl. A50W ..... **\$1.35**
- Modulation xfmr: 807 to pr 807's ..... 1.35
- Modulation xfmr: pr. 811's to 813 ..... 5.00
- Audio output transformer Split pri. 1500 OHMS each side. Secondary impedance 85 ohms center-tapped -6:1 ratio. 100 watts output. .... **\$7.50**
- Line to Voice coil transformer. Pri 600 ohms Sec 6 ohms. 1200 Test volt ..... 1.75

## Sangamo Mica Condensers

- F8L .0003 mfd 8000V list \$29.00 ..... **\$3.75**
- F8L .0015 mfd 8000V list \$31.00 ..... 4.00
- Solar type SX .0015 mf 3000V list \$9.95 ..... 75
- Sangamo G-4 .004 mf 20kv list \$110.00 ..... 25.50
- Sangamo G-3 .006 mf 10kv list \$87.50. .... 19.50

## WAVE GUIDE PARTS



**MAGNETRONS!!** Type 2J32 (JAN.) just released. The 2J32 is designed for 10 cm. operation. Rated at 300 kw peak pulse power. Complete information supplied. Brand new, packed in individual protective cartons. The 2J32 is listed at \$200. OUR PRICE... **\$25.00**

3J31's just received. One cm. magnetron listed at \$95.00. OUR PRICE... **\$20.00**

**KLYSTRON** oscillator tubes 2K25/723ab designed for 3 cm operation. New, packed individually. Listed at \$38.00, reduced to ..... **7.75**

1B24 TR tube (3 cm) ..... 2.98

Duplexer using 1B24 ..... 10.00

80 mc oscillator-amplifier with 2 6AC7's. Uses 723ab, Waveguide input, xtal detector. .... 10.00

With 6AC7's 723ab and IN21 ..... 16.50

Thermistor Beads (D-170396) for use with UHF and Micro-Wave Equipment (List \$3.00). In separate sealed containers ..... .95

## 3 CM WAVE GUIDE SECTIONS

- Silver Plated Narrow Band Directional Couplers with a 20 DB drop with:
- A. Straight wave guide section 6" ..... **\$ 9.95**
- B. 15° bend in wave guide 15" ..... 5.90
- C. 30° bend in wave guide 10" long ..... 4.75
- D. 90° bend in wave guide 15" long also 90° bend in coupler ..... 6.50
- SECTIONS**
- E. 2 1/2 foot silver plated with 90° bend (2" radius) ..... 5.50
- F. 150° bend with 90° twist 3 1/2" radius with pressurizing nipple and coax coupler ..... 3.95
- G. 2 1/2 foot 3 cm wave guides choke to cover fitting ..... 4.95
- H. 5 foot 3 cm wave guide section per foot. .... 1.95
- J. Feed Horn 3 cm ..... 3.50
- Send for List

## OIL FILLED CONDENSERS

- |                          |                          |
|--------------------------|--------------------------|
| 500 mf 200 vdc .. \$1.95 | 10 mf 600 vdc pyr 1.49   |
| 2000 mf 50 vdc .. 2.00   | 15 mf 600 vdc ..... 4.85 |
| 4000 mf 30 vdc .. 2.25   | 1 mf 1000 vdc ..... .90  |
| 1 mf 300 vdc .. .25      | 2 mf 1000 vdc ..... 1.10 |
| 2 mf 300 vdc .. .30      | 1 mf 1500 vdc ..... 1.20 |
| 4 mf 300 vdc .. .35      | 4 mf 1500 vdc ..... .30  |
| 4 mf 400 vdc .. .55      | 2 mf 600 ac/1000 .95     |
| 1 mf 600 vdc .. .35      | 2 mf 4000 vdc ..... 5.95 |
| 2 mf 600 vdc .. .40      | 1-1 mf 7000 vdc .. 4.95  |
| 3 mf 600 vdc pyr .65     | G.E. Pyranol .06         |
| 4 mf 600 vdc pyr .70     | mf 15,000 vdc ..... 5.95 |
| 6 mf 600 vdc pyr .95     | (List \$25.00) .. 5.95   |
- G.E. Pyranol 23F49 1 mf-5000v List \$27 ..... **\$5.95**
- C-D TC-50010 1mf 5000v (list \$30) ..... 4.50
- G.E. 14F191 1 mf 10,000v (list \$37) ..... 6.75
- .75 mf 20KV G.E. 14F136 ..... 22.00

## TUBE SPECIALS

Tube Type	Approx. List	Your Cost
3BP1	\$15.00	\$3.95
3BP7	27.00	2.98
5BP1	20.00	4.95
5CP1	45.00	4.95
5CP7	48.00	6.00
5FP4	35.00	4.95
5FP7	32.00	4.25
5JP2	48.00	8.95
827	2.80	1.50
872A	7.50	2.45
705A	22.50	6.75
241B-WE	85.00	50.00
801	155.00	95.00
2C40		5.95
2C43		8.95
715B		7.95

Sockets for 5CP1, 5BP1, 3BP1, 705a, 829, and 723 A/B tubes ..... .95 ea.

**B-29 COMPUTER AMPLIFIER**, containing 8-JAN6SN7 amplifier tubes, 1-6x5 GT, 8-relays, 3-neon glow lamps. Completely wired amplifier circuit with many components. This fine amplifier was designed for use with remote-controlled guns. This buy sells for ..... **\$9.95**

**POWER SUPPLY** for AN/APS-10, using 3-6x5 GT's, and 1-9006, complete with 6 chokes, 1 power transformer, and filter condensers ..... **\$4.80**

## Ohmite Wire-Wound Rheostats

- Model H 250 Ohms 25 Watt. .... \$0.99
- Model H 125 Ohms 25 Watt. .... .98
- Model J 1800 Ohms 50 Watt ..... 1.25
- Model K 3000 Ohms 100 Watt. .... 1.98
- Model L 250 Ohms 150 Watt. .... 2.25
- Model N 22 Watt ..... 3.00
- Model P 1200 Ohms 225 Watt. .... 2.75

All merchandise guaranteed. Mail orders promptly filled. All prices F.O.B. New York City. Send Money Order or Check. Shipping charges sent C.O.D.

# COMMUNICATIONS EQUIPMENT CO.

131-C LIBERTY STREET, WH 4-7658, NEW YORK CITY 7, N.Y.



## XTAL FILTER

I-F Crystal filter for BC-342. Resonant at 470 kc. Crystal included. **\$6.95**

**\$6.95**



Grasp the **NEW OPPORTUNITIES** in

# RADIO ELECTRONICS AND TELEVISION NOW!



Modern Radio — FM Broadcast and Reception — Television — Industrial Electronics; Power, Control, Communications — new equipment and methods demand new technical ability and experience. Keep up to date with the latest.

**MODERN RADIO  
EQUIPMENT FOR YOU  
TO USE AND KEEP**

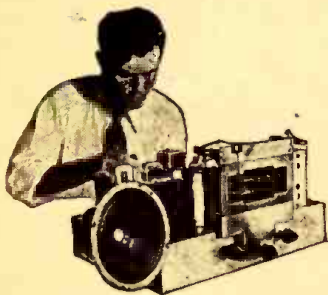

The very essence of National Shop Method Home Training is **EXPERIENCE**. You get actual experience by working with modern Radio and Electronic equipment—building many types of circuits. You may build a fine, long distance **MODERN SUPERHETERODYNE**, signal generator, miniature radio transmitter, audio oscillator, etc.—many other standard actual operating pieces of equipment—conduct cathode ray and other experiments. This practical work advances with your training—**YOU LEARN BY DOING!**

## Shop Method Home Training

By a Real Established Resident School with its own FM Studios, Shops and Laboratories.

### TRAIN WITH ADVANCED TECHNIQUE

The good jobs in Radio Electronics now go to the men who are equipped to handle them. It takes training and experience. National Schools, one of the oldest and largest trade schools in the country, makes it possible for you to get this training right in your own home in **YOUR SPARE TIME**.

National maintains modern resident training Studios, Shops and Laboratories where instructors and engineers are working constantly to improve training methods. **SHOP METHOD HOME TRAINING** is a logical extension of this practical system.

A **FREE** lesson that shows you how practical and systematic this new training method is will be sent you without obligation. You may keep and use this lesson to prove to yourself just how practical National Training really is.

Get one of the many **NEW JOBS** that demand new techniques and methods in Modern Radio. Get your share of the **NEW BUSINESS** that servicing the new sets and equipment demands. Experts agree that Radio, Television and Electronics present opportunities

much greater than ever before!

Radio is expanding with far-reaching improvements in reception. No one knows yet how great the Television market will be. Electronics will touch almost every walk of life—in industry and in the home.

**TURN YOUR INTEREST IN RADIO INTO A CAREER THAT WILL ASSURE YOU SUCCESS AND SECURITY.**

### FIND OUT WHAT NATIONAL TRAINING CAN DO FOR YOU

Where do you stand today in modern industrial progress? What does the future hold for you? You owe it to yourself to investigate this opportunity. With National Training **YOU GET AHEAD FAST**—you may step into a good position or start a business of your own, with little capital, even before you complete your National Course.

Fit yourself for a career of independence, good earnings, success and security in one of the fastest growing fields in industry. For full information, just send your name and address on the coupon and mail it **TODAY**.

# FREE LESSON



## Get This Book FREE

This big book presents the facts about the field of Electronics and your opportunities in it together with full information about the advanced National Training. Read it and make up your own mind that National Training will equip you for a great future. No salesman will call on you from National. The book is **FREE** with your sample lesson. Clip and mail the coupon **TODAY!**

APPROVED FOR  
TRAINING  
UNDER GI BILL



## See What National Training Has Done For These Men

National Shop Method Home Training wins good jobs, independence and security. Take the word of National men who have established records in their favorite Radio, Television, or other branches of Electronics.



From O. K. Ivey, Washington, D. C., comes this endorsement: "I believe National offers the best course to be had ... Keep up the good work."

Here's a statement from R. R. Wright, Blackfoot, Idaho: "Due to my training at National I was selected to instruct in the laboratory work of Navy and Marines."



Clifford Hannah, Portage La Prairie, Manitoba, Canada, writes: "My training has brought results as I'm in line for another raise thanks to National's encouragement and thorough training."



Joseph Michel, Jr., Granite City, Illinois, writes: "I am enthused with National training. I am now earning \$225 a month as a radio operator and technician and \$20 a week more in my shop at home."

Read what other enthusiastic students have written about National Training in the big 40 page book we will send you.

## NATIONAL SCHOOLS

LOS ANGELES 37, CALIFORNIA EST. 1905



### MAIL OPPORTUNITY COUPON FOR QUICK ACTION

National Schools, Dept. 2-RC  
4000 South Figueroa Street, Los Angeles 37, California

(Mail in envelope or paste on penny post card)

Mail me **FREE** the two books mentioned in your ad including a sample lesson of your course. I understand no salesman will call on me.

NAME ..... AGE .....

ADDRESS .....

CITY ..... STATE .....

Include your zone number

Check here if veteran of World War II





# ESSE Specials!

## SCR-522 100-156 Mc. RECEIVER AND TRANSMITTER

One of the most interesting and useful pieces of surplus equipment. Designed for plane and ground station use, this unit offers remote control of any four pre-selected crystal controlled frequencies in the spectrum of 100-156 Mc. This spectrum covers facsimile, air navigation aids, airport control, railroad, police, urban telephone, as well as the amateur band 144-148 Mc. October Radio News gives details for converting the SCR-522 receiver section, BC-624.

Transmitter section, BC-625, is voice amplitude modulated and has an output of 8-9 watts.

Tubes used and included: 2-832, 3-12A6, 1-6G6, 2-6X7, 1-12J5GT, 3-125G7, 1-12C8, 1-9002, 3-9003, 1-12A7GT.

These units were removed from planes but are guaranteed and are shipped in operating condition, including tubes, control head, and cable plugs ready to connect to dynamotor or other power supply.

Weight, 49 lbs. Shipping weight approx. 65 lbs.  
Price.....\$39.95 each

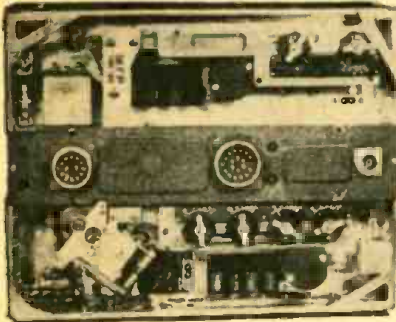

## TELRAD MODEL 18-A FREQUENCY STANDARD

Measures signals 100 Kc.-45,000 Kc., with check points at 10, 100, and 1,000 Kc. with a high degree of accuracy. Power supply is self-contained for operation from 110, 130, 150, 220, and 250 V. 25-60 cycles AC.

Complete with tubes, dual crystal, and instruction book.

Brand new, in original carton....\$24.95



## BC-375-E GENERAL ELECTRIC MOPA TRANSMITTER

Used as liaison transmitter in bombers and ground stations. Frequency range of 200-500 Kc. and 1,500-12,500 Kc. is covered by means of 7 plug-in tuning units furnished. By slight modification operation on 10 and 20 meters is possible. Oscillator is self-excited temperature compensated type. Power amp. is neutralized class "C" using 211 tube and is equipped with antenna coupling circuit to match practically any antenna. Modulator is class "B" using two 211 tubes. Power supply is 24 V. DC dynamotor which furnishes 1,000 V. at 350 M. A. However, transformer shown on this page is ideal for construction of 110 V. AC power supply. Transmitter output conservatively rated at 42.5 watts, phone 75 watts CW, but may be pushed to 150 watts.

Complete as shown with tubes, dynamotor, seven tuning units, and cable connector plugs. Removed from bombers but checked and guaranteed.

Price complete.....\$36.95  
Weight, approximately 150 lbs.



Dynamotor for 24 V. DC operation of SCR-522.....\$8.50. Wt., 39 lbs.



## LS-3 LOUDSPEAKER

6" PM type, housed in heavy metal case. For use on BC-348 Receiver. Self-contained output transformer to match 4,000 ohm impedance. Used but guaranteed satisfactory.

Price.....\$7.50 each



## BC-348 COMMUNICATIONS RECEIVER

Excellent selectivity, sensitivity and stability make this the most outstanding of any receiver yet available from government surplus. This receiver will give outstanding performance wherever used. Built to withstand vibration and features gear driven 100-1 ratio vernier tuning control. Six bands—200-500 Kc. and 1.5-18 Mc. Two stages RF, 3 stages IF, BFO, crystal filter, manual or AVC. Complete with tubes and 24 V. DC dynamotor. Easily converted to 110 V. AC operation. These receivers used, but can hardly be told from new. Guaranteed operation. Models N, M, P, and Q available—please specify.

Price.....\$44.75 each

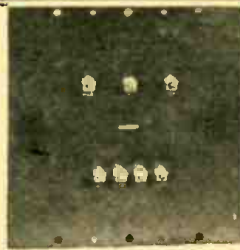

## H. V. PLATE POWER TRANSFORMER

1425-0-1425 sec. at 750 ma. Pri. 110-115 V. 60-cycle, tapped for low and high power. These transformers were made for RCA equipment. Size, 10 1/4" x 10" x 8" Weight, 81 lbs.

Brand new.....\$17.50 each

3-10 Hy. 750 ma. Swinging Choke for filtering of power, 5,000 V. insulation. Size 6 1/2" x 7 1/4" x 8".

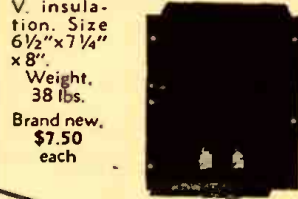

Weight, 38 lbs.  
Brand new, \$7.50 each

**TERMS:**  
CASH with ORDER  
or 25%  
BALANCE C.O.D.  
All Items  
Shipped Collect

# ESSE Radio Company

130 W. New York St. - Indianapolis 4, Ind.



# ESSE

# Specials!



### AN/PRS-1 MINE DETECTOR

For detecting metallic and non-metallic substances by oral or visual indication. Used for locating pipes, treasure, etc. Complete as shown with spare tubes, carrying case and ready to operate by connection of batteries not included. Shipped in original overseas moisture-proof container.

Price, brand new.....\$14.95  
Weight, packed for shipment, 101 lbs.

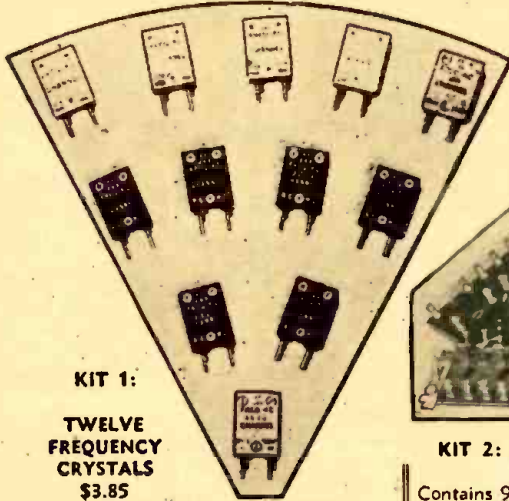

### KIT 1:

### TWELVE FREQUENCY CRYSTALS

Contains assorted frequencies between 3,000 Kc. and 8,000 Kc. in FT 243 crystal holders. We pick at random from mixed supply and cannot select frequencies.

Complete Kit of 12 Crystals.....\$3.85



### KIT 2: 25 RESISTOR MOUNTING STRIPS AND TERMINAL LUGS

Contains 9 bakelite resistor strips for mounting 2, 4, 9, 23, and 28 resistors which may be cut apart for any requirement. Also contains sixteen 1, 2, 3, and 5 lug terminal strips.

Complete Kit.....\$0.95

### ITEMS FOR THE RADIO AMATEUR, EXPERIMENTER OR SERVICE MAN

Available in kit form at a small fraction of their original cost—all brand new.

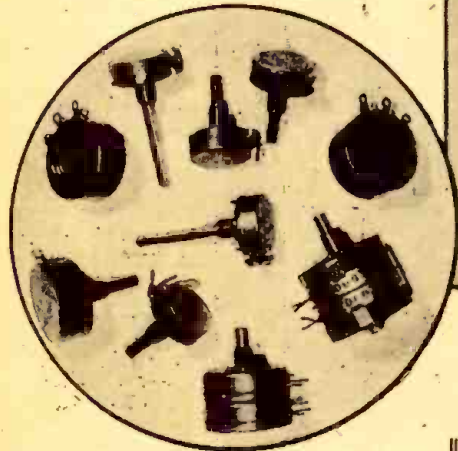

### KIT 5: 10 POTENTIOMETERS

Contains 3-.5 meg. carbon with 3/8" length shaft, 2-3500 ohm carbon 1 1/2" shaft, 1-1000 ohm wire wound 3/8" shaft, 1-dual 25,000 ohm wire wound with 3/8" shaft, 1-dual 30,000 ohm wire wound with 3/8" shaft, 2-100 ohm wire wound with screw driver adjustment.

Complete Kit of 10 Potentiometers.....\$2.85

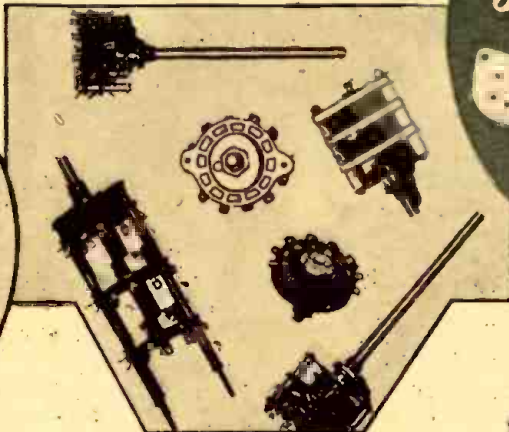

### KIT 4: 6 ROTARY TAP SWITCHES

Contains: 1-3 pole 11 position non-shorting; 1-2 pole 5 position non-shorting; 1-6 pole 4 position non-shorting; 1-1 pole 9 position non-shorting power tap; 1 ceramic insulated special; 1-6 pole 4 position with double contact wipers on 4 poles and 2 positions on 5th pole.

Complete Kit of 6 Switches.....\$1.85

### CARBON THROAT MICROPHONE

Ideal for plane, portable, or mobile operation, also for construction of lie detectors, toys, etc. You can't afford to be without a few at the price. Adjustable elastic strap fits any neck. Works into 200 ohm impedance input circuit. Used, but in good condition.

Price.....\$0.25 each

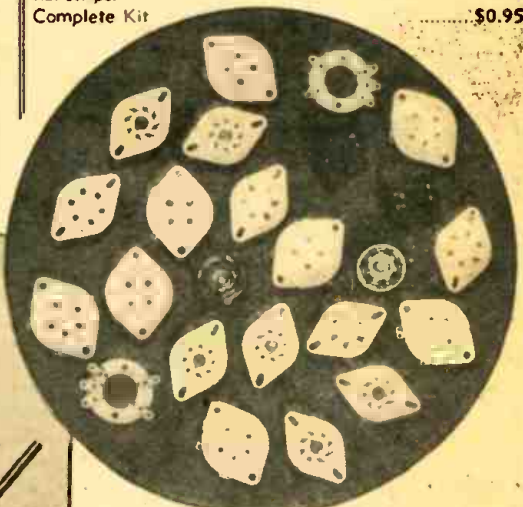
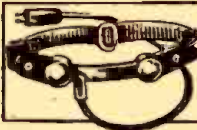

### KIT 3: 24 TUBE SOCKETS

Containing the following new Ceramic lo-loss-sockets: 2-Acorn, 6 octal Amphenol, 4-6 prong Milten, 4-5 prong wafer, 4-4 prong wafer, 2 molded bakelite, 2 octal female plugs and 2-7 prong tube tester sockets with center socket for checking pilot lamps.

Complete Kit.....\$2.35

### Plate and Filament Transformer:

650 V. Ct. 150 Ma.,  
6.3 V. 7.5 Amp., 5 V.  
3 Amp. Secondaries, 110  
V. 60 cycle AC Primary.  
An excellent buy for the  
set builder.  
Brand  
-New.....\$1.95



# ESSE

# Radio Company

130 W. New York St. Indianapolis 4, Ind.



# SPRAGUE TRADING POST

**WANTED** — Triplet models 1241 and 1232-A in good condition. Harv Weston 301 .001 ma. AC and .001 ma. DC, new, never used. Also Solar CB-160. Philco 925. RCA TMV-97-C. All in good operating condition. John Morrison, Box 4264, Oklahoma City 9, Okla.

**SWAP OR SELL**—Oscilloscopes, oscillators (RF and AF), Presto recorder, Melasner 14-tube receiver, 211E and 204A tubes, old parts of many kinds including loose couplers, DeForest HR and 990 tubes and Riders 1 and 2. Want tele equipment and Riders 5 and 10. Henry's Radio Service, 10 Fountain St., Newport, R. I.

**FOR SALE**—Melssner 150-B transmitter with shifter and extra parts and S20R receiver, both like new. Have extra service parts to sell. Write for list, stating what you need, Wayne Storch, Beecher, Ill.

**FOR SALE**—RME-99 with matching speaker, 12-tubes like new, \$150. Want tube tester, voltohmmeter, sig. generator, DM-5 converter, and movie lamp socket for Airline model 62-311. Capt. Chas. E. Splitz, Sqdn. K-1, Boca Raton Army Airfield, Florida.

**WILL SWAP** model airplane engine, airplane kit and all accessories worth \$40 for surplus SCR-284 or BC-654-A Receiver-Transmitter, or any other ham equipment. What have you? B. Kopecki, 2910 W. 3rd St., Chester, Pa.

**SWAP OR SELL**—40 new IF's, 455 KC air-trimmed from Hammarlund Super-Pro. List \$4.50 ea. Will swap for suitable sig. generator. Hurton M. Saks, 165 E. 10 St., Brooklyn 26, N. Y.

**FOR SALE**—1944 Scott Short-Wave Receiver, model RCH, U.S. Navy special, 80 kc. to 24 mc., 5 bands, \$109. Also Hammarlund HQ 120X, \$100. R. J. Blattner, 510 N. Bouldin St., Baltimore 5, Md.

**WANTED**—Cash for broken down radios. Write to Edward C. Punt, 397 Melrose St., Brooklyn 6, N. Y.

**WANTED**—Melssner signal shifter. Have Flimo 8 mm movie camera with case, Howard 430 communication receiver, Underwood portable typewriter, W. M. McDonald, 13 Cooper St., Greenwood, Mass.

**FOR SALE**—New 30-watt phono transmitter with coils, xtal and tubing antenna, Radio Physics course and manuals. Want HT-6 10-meter coils and crystals. Chas. Holstein, 246 E. 149th St., Bronx, New York.

**FOR SALE**—Abbott TR4 2-meter rig complete with dual power supply, tubes and hand microphone. Power supplies are 6 volt vibrator and 115 volt AC input, 300 volt, 100 mill. output, \$40. Frank J. Riggs, 5328 East Drive, Rockford, Ill.

**FOR SALE**—RDC 1000 ohms-per-volt multimeter AC-DC, portable type in wood case, uses 4" meter. In perfect condition. Postpaid for \$14.95. J. Goldstein, 151-09-34th Ave., Flushing, L. I., N. Y.

**FOR SALE**—Components from Russian tank transmitter, coils, variometer, dynamotor, phones, etc. P. E. Dickey, 237 Green St., Schenectady 5, N. Y.

**FOR SALE**—Western Electric BC-412-A oscilloscope, \$35, or what have you to trade? G. Doty, 1036 S. Broadway, Dayton 8, Ohio.

## SWAP - BUY - SELL

**SELL OR TRADE**—2 Chicago Instrument #431 pocket V-O-M's (one new) complete with instructions and test leads. Also Beedo 0-1 milliammeter. Need P. A. speaker, sig. generator or what have you? Tom Erwin, 3735 Milwaukee Ave., Chicago 41, Ill.

**FOR SALE**—HRO in rack, all coils and noise limiter; 10 meter mobile xmitters —10, 15 and 15 watts; various Pioneer Generators, custom built commercial police 250-watt phone, beautiful 6' cabinet, L. Qulnian, 3344 Park Ave., Weehawken, N. J.

**WILL SWAP** one late model 805 R.C.P. tube and set tester. Want a portable recorder. Chas. B. Alexander, 299 Howard St., New London, Conn.

**WANTED**—Copy of T.M.-11-879 or similar on BC 1335 surplus transmitter; also manual on 1D-59/APA-11 indicator and AM-5/APS-4 scope control unit. Murray J. Douglas, Box 506, Concord, Calif.

**WANTED**—All kinds of test eqpt., also technical books and manuals. Send full descriptions and prices. Have some meters to sell or trade. Sam Berenblum, 417 Greenwich Ave., Greenwich, Conn.

**FOR SALE**—Modernized Supreme 502S tube tester and analyzer 25,000 ohms per volt meter sensitivity. Like new. Also old model Jewell multimeter with two meters and Precision resistors, excellent condition. Micks Radio Service, P. O. Box 212, Marlon, Ky.

**FOR SALE OR TRADE**—Record changer, twelve 10" records or ten 12" records with port. carrying case, 3-tube amplifier with Shure miko. Also, almost new Crystalliner. Want Rider's Manuals, recorder or sig. generator. Smith's Radio Service, 21 N. Walnut St., Dexter, Mo.

**SWAP OR SELL**—Hickox 19X sig. generator, fine condition, 100TT's, 828's 811's, 803's, 813's, 807's, RK34's. Want .257 or .270 rifle, binoculars, good jig saw, also bench drill press. R. M. Short, 1509 N. 16th St., Boise, Idaho.

**FDR SALE**—Supreme #582 sig. generator and fre. mod., \$45. Supreme #562 auto-lizor \$85. Supreme tube tester #503, \$45. Supreme #547 multimeter, \$40. All in good working condition, Dixie Radio Shop, Jonestown, Miss.

**FOR SALE**—Hallcrafters communications receiver SX-32, 13 tubes, 6 bands, 8 point crystal selectivity, with Jensen speaker in Bud steel cabinet. Excellent condition, \$135 f.o.b. Fred E. Fraick, 724 No. Church St., Salem, Oregon.

**SWAP OR SELL**—One ea. of following tubes: 12S17, 2326, 3525, V.R. 105. Also several 5000 ohm small sensitive relays and two 8,000 ohm G.E. relays. Melvin Youngman, 515 South Blvd., Oak Park, Ill. Wanted—Used test equipment in fair or good working condition. Cash. Give full details and price. Fritz Dubler, 126 Bellevue, Rutland, Vt.

**FOR SALE**—Howard 435 RCVR just re-conditioned and aligned. Also two 1350v. C.T. 300 ma. sealed. Thor. transformers, \$5 ea. W. T. Rainey, Jr., Fayetteville, N. C.

**FOR SALE**—T.R.4 2 1/2 meter rig complete, \$30. Hallcrafters S39 receiver, 4 months used, \$60. Misc. transmitter eqpt. for sale. Write for list. V. Howerdel, 102 Hancock Ave., Jersey City 7, N. J.

**FOR SALE**—Rider Channel Model 162-C, new, in perfect condition, \$125. R. B. Hodgo, Ace Radio Shop, 503 W. Main, Grand Prairie, Texas.

**FOR SALE**—Hallcrafters S-40 Communication receiver, excellent condition, used only about 2 months. Wilburn Wright, Box 203, Hodgenville, Ky.

**FOR SALE**—Receiving tubes, boxed, 40%, 50% off list, condensers, resistors, power transformers, speakers, etc. Send for lists. Could use movie, reflex camera, s-w receiver. E. Schmitka, Apt. 4E, 1481 Shakespeare Ave., Bronx 52, New York.

**FOR SALE**—Solid silver buss for UHF 16 ga., approx. 9" roll, \$1.25. Rest for efficient coils and tanks. Also have new RCP 448 pocket multimeter, 2000 ohms/v, 16 ranges, \$22. R. J. Cartwright, 69 Mountfort St., Boston, Mass.

**FOR SALE**—TR-4 transceiver, converted for use on 144 mc. complete with hand mike, power pack and new tubes, \$50. R. V. Russell, 25 Elk Place, Niagara Falls, N. Y.

**FOR SALE**—Electronic multimeter, model 400, \$45. Aaron Hollandmritz, 918 N. Madison Ave., Bay City, Mich.

**WANTED**—Rider manuals 8, 10, 11 and 12 also following tubes: 1LE3, 6A8, 7A8, 251B, Royce Saxton's Radio Shop, Rt. #1, Pontiac, Ill.

**SWAP OR SELL**—HRO coils; gen. cov. 100 kc to 480 kc 1.7-30 mc. Need small communication set. Bill's Radio Service, 1747 West 6 St., Brooklyn, N. Y.



### Replace Wet Electrolytics with SPRAGUE TYPE RW

When replacing wet electrolytic capacitors, use Sprague Type RW. They're not substitutes! They're dry electrolytics of very high voltage formation specifically designed for use as wet replacements or for other difficult applications. Due to their extremely low power factor, lower capacity values give you better filtering. For instance, Type RW-25 rated at 25 mfd. is at least the equivalent of a 40 mfd. wet electrolytic. They'll stand high peak surges. They'll handle a-c ripples—and they fit the standard mounting holes. Ask your jobber for Sprague Type RW.

Write for the complete Sprague Catalog listing Capacitors and \*Koolohm Resistors for every radio service, amateur and experimental need.

Address Ads to: Dept. RC-27

# SPRAGUE PRODUCTS COMPANY

NORTH ADAMS, MASS.

JOBGING DISTRIBUTING ORGANIZATION FOR PRODUCTS OF THE SPRAGUE ELECTRIC CO.

## YOUR OWN AD RUN HERE FREE!

Sprague will gladly run your own TRADING POST ad free of charge in the first available issue of one of the six radio magazines in which this feature appears. WRITE CAREFULLY or print. Hold it to 40 words or less and confine it to radio subjects. Sprague reserves the right to rewrite ads as necessary, or to re-

ject any that do not in our estimation fit in with the spirit of this service.

*Harry Nathan, Sales Manager*

### ASK FOR SPRAGUE CAPACITORS and \*KOOLOHM RESISTORS by name!

\*Trademark Reg. U.S. Pat. Off.



# RADIO PROGRESS IS SLOW

## *Radio Progress Is Evolutionary as Is Any Normal Growth*

**R**ADIO-CRAFT continuously receives letters from readers who deplore the slow general progress in radio. Many correspondents lament that the promised and glowingly advertised radio wartime inventions so far have not materialized in our peace economy.

They ask: Where are the radar applications for autos, private planes, and motorboats? What about the proximity fuse's miniature radio device—why don't we have it in our pocket sets? What about those "printed" radio circuits doing away with most of the present-day wired radio sets? And a host of other similar questions.

We had occasion to speak of this some months ago. Because of the continuing interest, we present a number of further pertinent facts on the problem:

Radio progress is certainly not slower than progress in any other field. It may even be said that it has advanced at a rather fast rate, if we wish to draw parallels with other arts.

Robert Fulton built his first steamship, the *Clermont*, which became known as "Fulton's Folly," in 1807. Yet many decades elapsed before commercial steamships became a reality. The incandescent lamp was first demonstrated by Edison in the year 1877, but it was not till about 1883 that electric lights were first used in private homes—extensively not until about 1890.

The Diesel engine was invented by Diesel in the year 1892, but Diesel locomotives came into use only in 1924.

You can make a long list of similar inventions and you will find that from the demonstration of the early model to the successful commercial use of the device there is always a time lag that may cover a number of decades.

Radio's most important invention—the audion, the three-element vacuum tube—was invented by de Forest in 1907. Yet in 1920-22 we were still using crystal sets, and it was over 19 years from 1906 to 1925-27 before vacuum-tube sets were produced on a mass basis. Nor is the audion an exception.

Modern broadcasting itself was first demonstrated by Lee de Forest in the year 1907. It did not become a reality until the Pittsburgh Westinghouse station KDKA started regular broadcasts in the year 1920. Similar delays are true of all radio inventions and developments. There is usually a lag from 10 to 20 years before the early model is translated into a full-fledged commercial reality.

The reader may well ask the reasons for this seemingly slow progress in radio. They are simple once the great difficulties of pioneer inventions are understood.

In reality, there is nothing wrong with radio—or other inventions for that matter—it is always the human beings who are slow to grasp new things. Nor is it the layman who is slow. Quite the contrary—usually

the public is far ahead of the technician. Manufacturers, engineers, and those others who are really supposed to know, are slow and put obstacles in the way of every new invention and forward-looking device.

Just to mention one case, note that when Dr. Lee de Forest first presented his audion to the Navy—which certainly had excellent radio people—he was given a long list of reasons why the audion or vacuum tube was no good and should not work!

It is a fact that, when confronted with something of a revolutionary nature, technicians immediately begin to find fault and see reasons (probably good ones at the time) why the device is not practical. Here the engineer is probably right, because a crude model of an invention IS full of faults, has an extraordinary amount of "bugs," all of which must be eliminated. This is usually a long-winded, heart-breaking process. The manufacturer, too, knows that an early model—or even a semi-perfected one is usually an invitation to spend fortunes over many years before the article can be sold commercially. The manufacturer knows only too well that what works well in a laboratory may fail completely in the home or in the hands of the public. Books have been written on this phase alone. Many manufacturers have gone bankrupt in backing an invention which was theoretically sound, but which had not been developed sufficiently to be placed in the hands of the public.

All this, however, is only one phase. There are other more important ones. Chief of these are patent questions. Few patents may be termed "basic." Only a few such patents come along during the year. Even if they are as basic as the audion, there is still trouble. While de Forest had many patents on the audion, that did not prevent others from suing him in connection with special manufacturing processes and the internal structure of the vacuum tube.

*An invention, no matter how good, is of no value at all if you do not have the machinery to build it.* Often such machinery is more important than the device itself. As an example of this let us point out only one.

The slide-fastener, popularly called the zipper, was a basic invention. Yet this invention was quite useless without the highly complex machinery necessary for mass production. In this instance the machine to produce the device was really the heart of the invention. Many similar parallels can be cited.

There are still other phases of equal importance. These are purely economic in nature. It is most difficult in many instances to secure capital for new and unproved inventions. Bankers and capitalists are extremely hesitant about investing money in them. They know from

*(Continued on page 51)*



# RADIO-ELECTRONICS

## Items Interesting

**SINGING COMMERCIALS** are banned from the Argentinian ether waves by an ingenious regulation, an American advertising man just back from Buenos Aires reported last month.

Hearing no musical advertisements during a three-day stop in the Argentine, he investigated, and found that commercial jingles and ditties had been introduced into the country several years ago. They had cluttered up the pampas airwaves to such an extent that protests of music lovers prodded the *Direction de Radiodifusion* into action. Unable to discriminate against the singing as opposed to the spoken commercial, the Argentine version of the FCC simply clamped down a rule against all recorded commercials. Now every advertising word has to come directly from the announcer's lips. And without recordings, singing commercials are impractical.

**THE BLUE BOOK** of the Federal Communications Commission, which became the center of an etheric storm immediately upon publication, has become so popular—or the reverse—as to necessitate another printing, a last month Washington report states.

The book "Public Service Responsibility of Broadcasting Licensees" dealt with the type of service the Commission felt listeners had a right to expect from their broadcast stations. Issued originally in an edition of only 5,000 and priced at 25 cents, it sold out rapidly, as did another edition of 6,500 published by the National Association of Broadcasters. The Commission accordingly had to make arrangements for reprinting several thousand more copies at the same price with the Superintendent of Documents of the Government Printing Office, who is also in charge of sales of the book.

**RADAR WAVES** from 1.2 to 1.6 centimeters in length have found a new use in microwave spectroscopy developed for the analysis of chemical substances.

Identification of whole molecules is accomplished by beaming microwaves

through the vapor of the substance to be analyzed. Certain wavelengths of these microwaves are absorbed by those molecules which they cause to rotate in resonance. Molecules of different substances absorb a different series of wavelengths. Thus for each substance there is a characteristic pattern of absorption lines which when projected electronically on a screen present an easily identifiable "fingerprint" of the vapor under investigation.

The basic elements of the microwave spectroscopy as developed by Drs. William E. Good, Donald K. Coles and T. W. Dakin of the Westinghouse Research Laboratories are an oscillator tube or radar tube, waveguide, crystal detector, oscilloscope and sweep generator.

Microwaves emitted by the oscillator tube are directed through a rectangular waveguide which contains the sample gas or vapor to be analyzed in a gas cell section that is sealed off with plastic tape. At the far end they are picked up by a sensitive crystal detector which passes the impulse received on to the oscilloscope. For clearer definition of the absorption lines the vapors in the gas cell are held to a pressure of about 0.1 mm of mercury.

The oscillator tubes used to obtain microwaves in wavelengths varying from 1.2 cm to 1.6 cm are reflex klystrons, tuned by changing the size of the resonant cavity. Several tubes are used to cover the band required.

The frequency of the oscillator tube, or klystron, is swept in synchronism with the horizontal sweep of the oscilloscope tube, and the output of the crystal detector is applied directly to the vertical plates of the oscilloscope so that absorption at particular frequency will be recorded as a vertical deflection of the oscilloscope trace.

Ammonia has been found to have a pattern of 30 distinct absorption lines in this region. Other compounds that have been tagged by this method are water vapor, acetone, cyanogen bromide and carbonyl sulfide. The limitations of the microwave spectroscopy are not yet known, but it promises to be a very valuable tool in the study of molecules and even of the atomic nuclei within the molecule.

**RADAR SAVED** two radarless steamships from head-on collision during a blinding snowstorm on Lake Superior last month when an officer aboard a third ship perceived the danger on his ship's radar indicator and warned them by radio to change course, according to Charles J. Pannill, president of Radiomarine Corporation of America.

First Mate Tom Hermansen of the ore carrier A. H. Ferbert, aboard which Radiomarine recently installed a new type of three-centimeter merchant marine radar, was watching the radar just before dawn on November 28 when he observed that the luminous "pips" representing two other ships on the radar image were rapidly converging from opposite directions.

Realizing that lookouts on neither vessel could see the other ship in the snowstorm, Hermansen immediately contacted the two ships by radio, warned them of their danger, and directed each on a change of course which averted the collision.

It was reported that the two vessels were the SS J. H. Sheadle and the SS Sascatu, and that the officers of both vessels had been unaware of their danger until they were warned by Hermansen.

**GROUND CONTROLLED** approach (GCA) will be in operation at 56 airbases in this country and overseas by midsummer, the Army Air Forces reported last month. Every major AAF installation in the country could be equipped with this important blind-landing device if sufficient trained personnel were available, the Army reports.

The Mark II production model of GCA, used in all theaters of operations by the AAF, requires from three to five operators, or controllers, on each eight-hour shift. This means that a minimum of nine trained controllers are needed to keep one Mark II GCA unit in operation 24 hours, or a total minimum of 1,170 controllers to have the Army's stock of stored GCA units functioning.

The Mark III and IV, the 1946 model, requires only one controller on a shift. However, these new models will not become available to the AAF for some time due to shortages of critical parts and the present high cost of production.

**RADIO TUBE PRODUCTION** for December, 1946, hit a peak 40 percent above the former all-time high figures of 1941, stated M. F. Balcom, vice-president of Sylvania Electric Products, last month.

Since the number of types made was much smaller than in 1941, increases in production of many standard tubes is much greater than the overall figures indicate.



The recently-developed microwave radar-spectroscopy in operation.



# MONTHLY REVIEW

## to the Technician

### RADIO ITEMS OF THE MONTH

Billboard television is being studied by a large New England outdoor advertising concern. Present billboards are at a disadvantage because copy cannot be changed readily. Television technique would make them literally up-to-the-minute.

An electronic fire alarm uses a photocell which is sensitive to the ultra-violet rays emitted by flame. A special filter makes it insensitive to ordinary light, though it reacts to a fire in a few seconds, as compared to the minutes often required by heat-operated alarms.

Thirty thousand cars in the United States have already been outfitted with two-way telephones, according to the Society of Automotive Engineers.

Static generated by automobile tires may be reduced or eliminated by a new static suppression powder consisting of very finely divided carbon, says N. B. Settle, service director of the Dodge division, Chrysler Corporation. The powder, commonly known as acetylene black, is injected into the inner tubes with a special tool.

Television shows which feature hypnotism have been banned by both the BBC and NBC, after experimental telecasts indicated a possibility that members of the audience might be hypnotized accidentally.

A new microwave "electric eye" developed by General Electric uses centimetric waves instead of the usual light beam, and a parabolic receiving antenna instead of a photocell for receiving the beamed waves. Since the microwaves pass readily through non-conducting materials, it can be used for many purposes for which the ordinary photocell device cannot. For example, an electronic counter can be used to detect non-filled bottles on a conveyor line, even though the liquid with which they are to be filled be quite transparent.

**FOUR MILLION RADIOS**, more or less, will be equipped with FM in 1947, R. C. Cosgrove, president of the Radio Manufacturers' Association, predicted last month.

The exact figure estimated by Mr. Cosgrove was 3,750,000 receivers, which he expects will amount to approximately 25 percent of the 1947 production. Ninety percent of the console models to be made next year will have an FM band, he believes.

Production of television receivers was estimated at about 325,000 for 1947.

**RADAR** is now being used to detect meteors, a recent bulletin of the National Bureau of Standards announces. The Bureau believes that continued study of meteors will reveal information on the effect of meteors on radio waves which may be important in connection with FM and other v.h.f. broadcasting.

One way in which meteors may affect radio waves is to cause the "bursts" (parts of programs from long-distance stations interfering with local station performance) on FM channels. Some scientists, such as J. A. Pierce of Cruft Laboratory, Harvard University, believe that a large part of the ionization of the *E* layer of the ionosphere may be caused by meteors. A knowledge of the behavior of the *E* layer is of primary importance since it controls radio propagation on many of the frequencies used for radio communication and radio navigation.

Supporting evidence for these contentions was the fact that interference encountered on the old frequency modulation broadcasting frequencies in the form of "bursts" had been found to coincide with the appearance of meteors. Further, it had been reported that during the war radar operators tracking V2 rockets had been confused by reflections from meteors. Other radar observers, such as O. P. Ferrell, working in an unofficial capacity in India, had actually made observations which coincided with the visual observations of meteors.

**AMERICAN RADIO TRANSMITTERS** will make Munich the voice of democracy, redeeming that old city from the associations of appeasement and treachery which have sprung up around its name, according to a report from the State Department last month. Three transmitters, each of 85 kilowatts power, were placed in service in December to relay Voice of America broadcasts to Eastern Europe.

Special attention was attracted to the prospect of beaming Russian-language broadcasts from the United States into the Soviet Union. Programs are also directed to Czechoslovakia, Yugoslavia, Rumania, Poland, Bulgaria, Hungary, Austria and France.

**A NEW FM CONVERTER**, to enable old FM sets to pick up the new band, requires no tubes. It was described last month by Henry R. Kaiser, chief engineer of WWSV and its FM affiliate WMOT. Mr. Kaiser said:

"After converting our FM transmitter for operation on the new band, approximately 6,000 owners of the pre-war FM receivers in the Pittsburgh area ob-

viously could no longer receive our FM station WMOT. We did not feel justified in advising our FM listeners to junk their sets and buy new ones when they become available. Ignoring these sets as far as FM is concerned would have done anything but further the interest among enthusiasts who invested in FM receivers just a few years ago. The obvious answer to our problem was a converter to adapt a receiver to the new band.

While experimenting with a single-tube quartz crystal controlled converter at a location approximately fifteen miles from the transmitter (operating at the time with an estimated effective radiated power of not over 100 watts) the oscillator in the converter accidentally failed. Much to our surprise and gratification we could pick up the station on 94.5 megacycles at another spot on the dial of the receiver while trying to find a signal from the crystal



The tubeless converter is simplicity itself.

oscillator. We then found that the crystal oscillator was no longer functioning. The part of the circuit remaining consisted of two tuned circuits and a detector crystal—this became the tubeless converter shown in the schematic.

The unit is merely connected in series with the new high-frequency antenna's transmission line near the receiver. No other connections are necessary. The input circuit is tuned to the transmitter frequency and the output is tuned to a frequency in the old band. This latter frequency is the result of radiation from the local oscillator in the receiver mixing with the transmitter frequency and producing a converter output signal which falls in the range of the old band. In the case of WMOT which is on 94.5 mc, several types of receivers which we have tried tuned in the station when the receiver dial was adjusted to near the high end of the old band.

The coils were easily wound for the job. All are self-supporting and space wound, 7/16-inch in diameter. L1 is two turns of No. 18 insulated hook-up wire interwound with L2. L2 and L3 are of No. 10 solid enamel wire, L2 having 3 turns and L3 10 turns. L4 is 3 turns of the same wire as L1, and is interwound with L3. We had only three components to purchase for our converter. The two 8-plate midget air-trimmer condensers C1 and C2 cost 35 cents each and the Sylvania 1N34 crystal was \$1.60. Surplus radar crystals could be used in place of the 1N34 but although they can be had for as low as 39 cents, some of these crystals are probably rejects. In addition, small static charges in the antenna circuit may impair operation of some of these crystals whereas the 1N34 appears to have a greater current carrying capacity. Our converter cost \$2.39. (The nine cents covers the four screws and wire.)"



# 250-300 MC RADIOPHONE

## A Well-Engineered Portable Directional Transceiver

THE radiotelephone - i.c.w. transceiver shown on our cover was captured from the Japanese in the Pacific Theater. Resembling ham equipment in many respects—even down to the use of American tubes—some of its features may prove interesting to American amateurs.

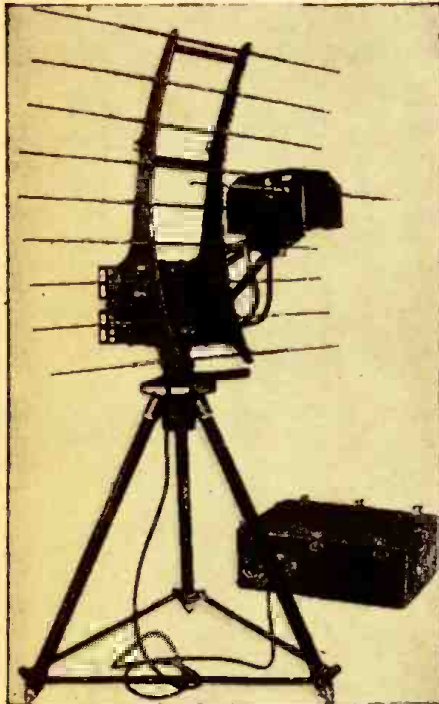

Photo A—The Mark 7, assembled for operation.

Known as the Type 96, Mark 7, this transceiver was designed for receiving and transmitting voice and interrupted-continuous-wave in a frequency range of 250 to 300 mc. Six slide-in coils are used to cover the range. A 955 acorn tube acts as a superregenerative detector in an Ultraudion oscillator circuit for receiving, and as a plate-modulated oscillator for transmitting. A 6F7 triode-pentode acts as a 300-kc quench oscillator and audio amplifier for receiving, and as a tone generator or modulator for transmitting. The range is given as five miles under ideal terrain and atmospheric conditions.

Photo A shows a right-front view of the assembled set with its high- and low-frequency units and the antenna array mounted on a tripod. The high-frequency unit is mounted in a box suspended in front of the parabolic reflectors of the array. The low-frequency unit and controls are mounted behind the reflectors and above the center of the tripod. Three jacks are placed in a vertical row along the right-rear edge

of the low-frequency unit. These jacks are for microphone, headphones, and a remote send-receive switch. A send-receive push-button switch is just above a flat mounting plate which supports a removable telegraph key. A key jack is located just below the mounting plate. Power for the set is supplied by a 6-volt storage battery and a 180-volt B-battery, housed in the box on the ground beside the tripod.

The antenna reflector system consists of nine dipoles tuned to the middle of the tuning range (272.7 mc). The driven element is a pair of adjustable dipoles screwed into the sides of the high-frequency unit. Telescopic adjustments permit these elements to be tuned precisely to the operating frequency. Fig. 1 shows the directional characteristics of the array. Maximum signal radiation is in a beam of 72 degrees.

Photo B is a close-up of the control panel located on the left side of the low-frequency unit. The large wheel in the center of the panel is coupled to the tuning condenser in the high-frequency unit through a length of flexible shafting. The regeneration control knob, below and to the right of the tuning wheel, adjusts the amount of voltage on the plate of the triode section of the 6F7 when it is used as a quench oscillator. The quench-oscillator coupling knob is used to vary the coupling between the pickup coil and the oscillator plate coil. The lever-operated modulation switch is below the control knobs.

### How It Operates

The modulation switch (the several sections of which are shown ganged in

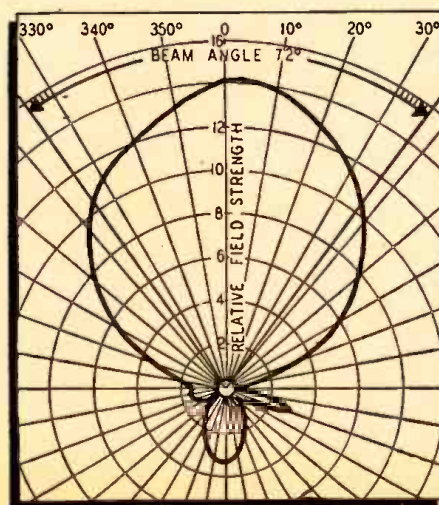

Fig. 1—Radiation pattern of parabolic array.

Fig. 2) has three positions; the center position is OFF and no plate or filament voltages are applied to the tubes. When the lever is moved away from the operator, the circuit is set up for reception of voice and interrupted-continuous-wave signals. If the send-receive button is pressed while the modulation switch is in this position, the circuit becomes a transmitter operative for voice transmission *only*. When the modulation switch is thrown toward the operator, the set becomes a transmitter for tone-modulated c.w.

When the set is used for receiving, the incoming signal is concentrated on the dipole by the reflectors and coupled to the grid of the 955 through the tank coil L1. At the plate, the signal is mixed with the quenching voltage from the triode section of the 6F7 so that the 955 becomes a separately quenched superregenerative detector. The a.f. signal at the plate is coupled through transform-

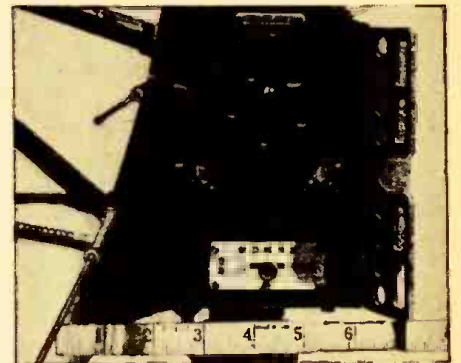

Photo B—Operating controls are on left side.

er T1 to the pentode section of the 6F7. Transformer T2 couples the plate circuit to the headphones.

The quenching voltage is generated in coils L4 and L5 and the triode 6F7. Coupling to the detector is controlled by the position of L6.

To transmit voice, the modulation switch is moved away from the operator. Pressing the send-receive switch shifts relays Ry-a and Ry-B to the transmit position. This removes the plate voltage from the triode section of the 6F7 by opening contacts 7-8. The output of the microphone is impressed on the low-impedance primary of M of T1. The secondary voltage of the input transformer feeds the grid of the pentode section which has become the modulator stage. The plate current of the 955 passes through the secondary of T2, through contacts 1-2 to the plate of the oscillator. The output of the modulator fully modulates the plate current of the 955.



Siditone for monitoring is secured by coupling the headphones to the secondary of T2 through a 0.5- $\mu$ f blocking condenser. The insertion of a 500,000-ohm resistor in the ground side of the phones through contacts 4-5 reduces the siditone to a comfortable level when transmitting. Ry-b connects L3 to the ground end of the tank coil. (The purpose of L3 and C1 could not be determined during the tests because there was no apparent change in frequency or quality when either was omitted from the circuit. It is possible that the designers felt that added inductance was desirable while transmitting and more capacity when receiving. This might account for the action of Ry-b.)

Tone-modulated transmissions are made with the modulation switch in the i.c.w. transmission position. Contacts 15-16 and 1-2 are closed, making the triode section of the 6F7 an audio oscillator using the primary and secondary windings of T1 to supply the necessary grid-to-plate coupling. Contacts 9-10 are opened so that plate voltage is applied to the pentode section only when the key is closed. The signal from the a.f. oscillator is amplified by the pentode section which functions as a modulator just as it does during voice transmissions.

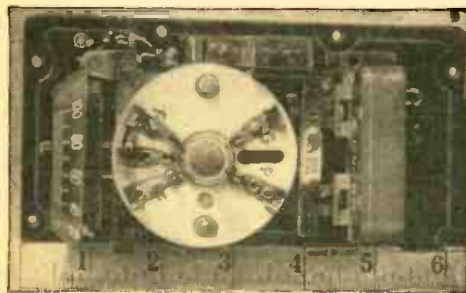

Top view of r.f. unit showing the 955 and one of the tuning coils plugged into its position.

Although the Mark 7 was designed for specific military applications, its circuit might be used as a basis for an amateur transceiver for operation on the 144-, 220-, and 420-megacycle bands by using coils and condensers designed to operate most efficiently on these bands.

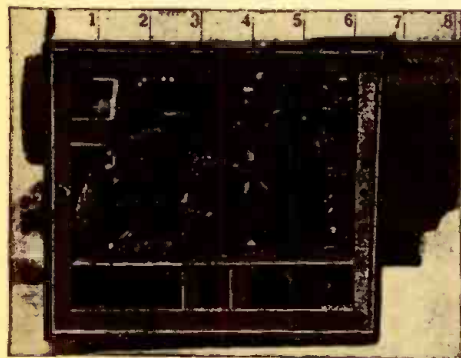

Rear view of a.f. unit showing quench oscillator coils, Relay A and the tuning gears.

Coils for the u.h.f. ham bands are wound with No. 18 wire on a  $\frac{1}{2}$ -inch form. (Silver-plated wire is more efficient, particularly on the higher frequencies.) The 144-mc coil has four  $\frac{1}{2}$ -inch turns spaced to approximately  $\frac{3}{4}$ -inch and the 220-mc coil has two turns

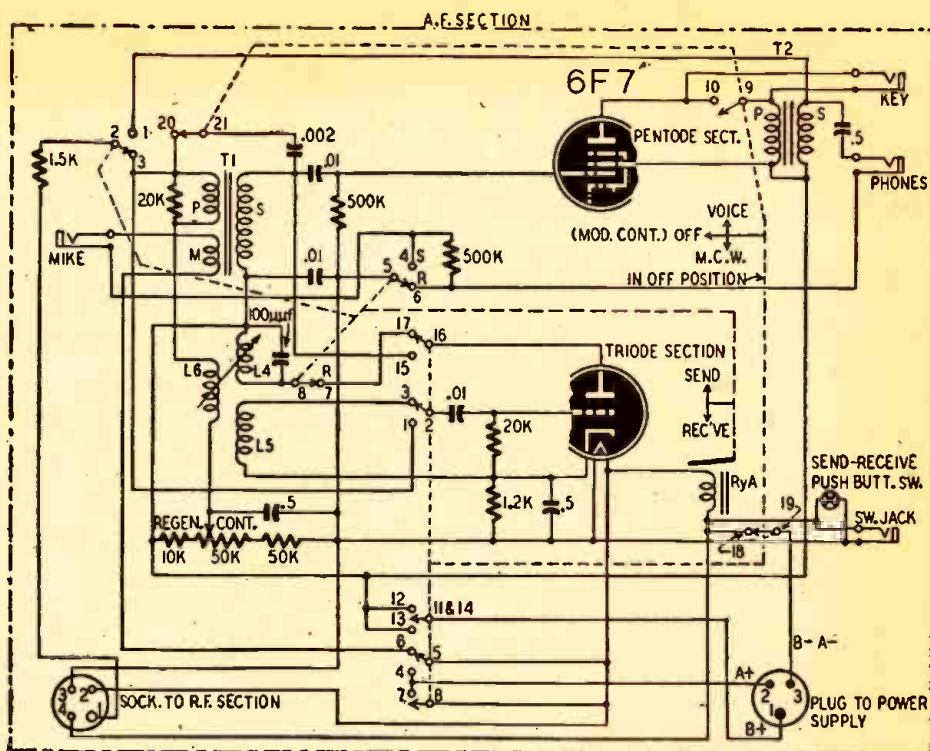
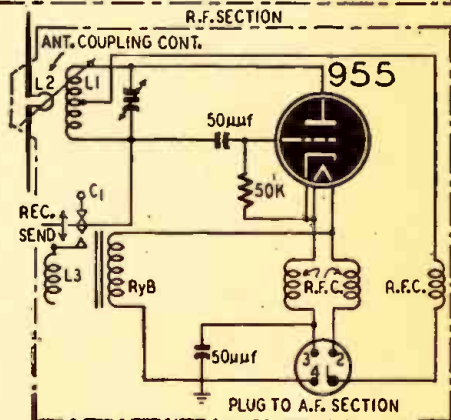

Fig. 2—A.f. section (above) and r.f. section (right) of the Mark 7. An ultraudion oscillator is used and many other points of similarity to regular amateur v.h.f. circuits will be noted.

spaced to  $\frac{1}{4}$ -inch. The 420-mc coil has only one turn and its diameter is varied slightly to hit the band. The tuning condenser may be a Cardwell ZV-5-TS which is designed for u.h.f. circuits. Its stator is divided into two segments. The capacity range is from 1.5  $\mu$ f to 5  $\mu$ f.

Technical material and drawings for this article on the Mark 7 were made available to us through the courtesy of the Department of Commerce.



## SIMPLE FREQUENCY MONITOR

**I**N THESE days of VFO, frequency multiplication and antenna-coupling networks, the wavemeter is a most indispensable item. Wavemeters and frequency meters are used to measure the same units but they meet different requirements. A wavemeter uses a simple tuned circuit which absorbs power from an oscillator under measurement. The indication is definite as to wave band but it is relatively broad. A frequency meter, as the term is generally used, is based upon an oscillating circuit which generates its own signal to beat with another. Although its frequency indication is sharp, the order of harmonic must be determined by some other method. Both types of meters are

useful in adjusting a transmitter.

A wavemeter can be used in several ways. Coupled to an oscillator, it absorbs maximum power from it when both are in resonance. Monitoring the output of the oscillator will show a slight change in intensity or frequency

(Continued on page 65)

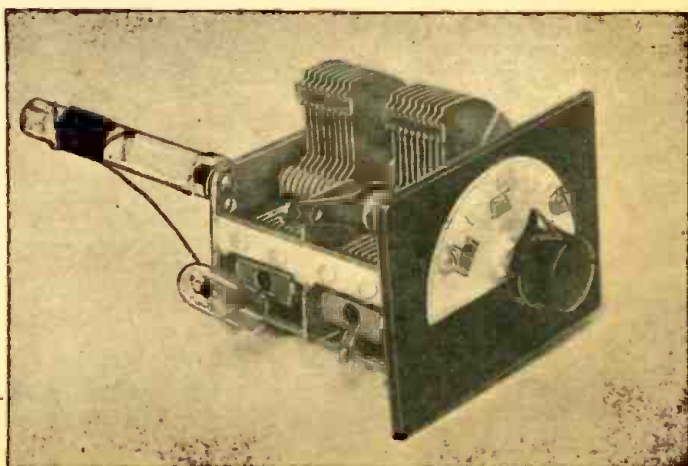



# HIGH SPEED PHOTO FLASH



## *A Portable Battery-Operated Unit Which Can Take 10,000 Pictures with One Bulb*

standard parts obtainable from hardware stores and radio parts jobbers. While the weight of the equipment is objectionable for some applications, the results have been very satisfactory. The units have been rebuilt a couple of times for greater operating efficiency and reduction in weight. Fig. 1 is the schematic.

An Electroflash bulb operates through the discharge of a high-capacity condenser which is charged to a voltage between 1,600 and 2,500. The capacity of this condenser may vary from 15  $\mu\text{f}$  to 100  $\mu\text{f}$ , depending on the size of bulb and the light output desired. The power unit consists of the large condenser, a power supply to charge the condenser, and associated relays to trip or trigger the flash in synchronization with the camera shutter.

Using a 9-volt battery, the power unit delivers 500 volts d.c. to charge 500  $\mu\text{f}$  of electrolytic filter condensers which are charged in parallel and discharged in series. Discharge voltage is between 2,000 and 2,500 volts, while the charge voltage is 475 to 500 volts. These may be regarded as peak ratings which are not to be exceeded because the electrolytics are 100  $\mu\text{f}$  units with 525-volt peak rating. Some question might be raised as to the life of electrolytics when used for this type of service. So far, after about 10,000 cycles, on two different and separate units, there has been no sign of capacitor failure, and a check shows that the capacity of individual units has increased slightly. Of course, for use in a series-parallel circuit, the capacities of individual units must be selected to match, although they do not have to be

any particular value; the important point is that all must have the same capacity (within about 10 percent). Otherwise an excessive peak voltage might be built up across one or more sections during discharge.

The series-parallel discharge circuit has certain definite advantages for photoflash work. It permits the concentration of a great deal of capacity in a small space with light weight. Standard components in a low-voltage power supply can be used. Since voltages are lower, the safety factor is greater and there is much less chance of getting a serious shock from any part of the circuit. The only time a voltage of 2,500 is present is at the instant of discharge of the series-parallel capacitor bank. At all other times the peak voltage will not exceed 500 volts. The operating range for successful pictures is between 400 and 500 volts. Since the camera shutter is tripped by a magnetic relay, camera and flash bulb may be operated by remote control to take pictures otherwise difficult, dangerous, or impossible to get.

Battery drain averages 4.5 amp. Drain starts at 9 amperes and tapers rapidly during the 10-second charge interval to about 2 amperes. With care, as many as 2,000 pictures can be taken with a single set of batteries. The bat-

**W**EIGHING only 23 pounds, this camera and repeating flash unit will take over 1,000 pictures on a single set of batteries and 10,000 or more pictures on a single flash bulb. The Amglo cold argon light produces flashes with terrific intensity for about 1/10,000 second, to stop the fastest motion. Requiring only 10 seconds to recharge between pictures, a complete 60-exposure roll of film may be taken in 15 minutes.

The equipment shown in the photographs was built by the author from

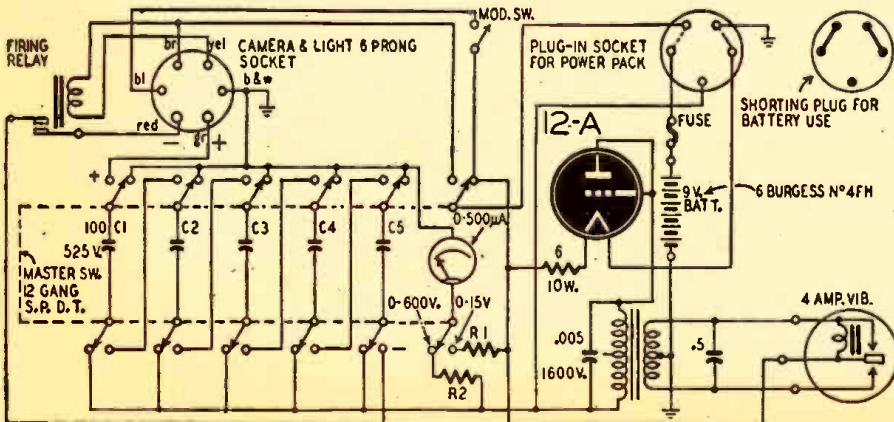

Fig. 1—Schematic of the main unit. Sockets and plugs are for a.c. power supply and camera.

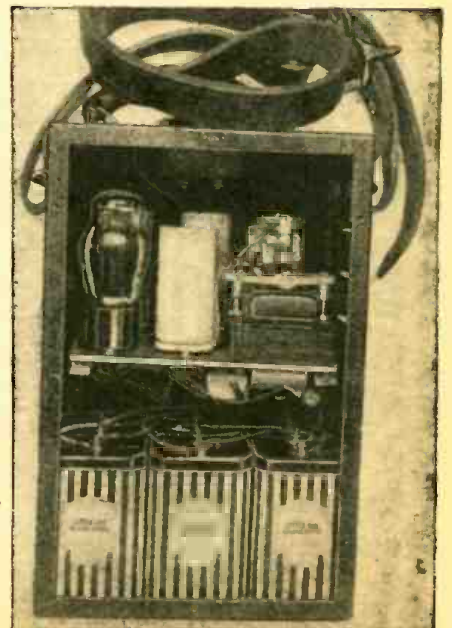

Photo B—A rear view of the photoflash unit.



tery used for these tests was made up of six Burgess 4FH "Little Six" cells as shown in Photo B. Other batteries would work, but this particular type fits the case very nicely and has given excellent results. As the batteries get older and weaker recovery time is slower (it may exceed 20 or 30 seconds), and therefore 1,000 pictures is set as an average. For the first 1,000 pictures the recovery time will not exceed 15 seconds if proper care is used and the power unit turned off quickly when not in use.

The unit was built into a standard 7 x 8 x 12-inch metal portable carrying case, obtainable from any radio parts jobber. As shown in Photo C the parts fit into this case without overcrowding and with little wasted space. Since some of the parts used were salvaged from other equipment, no dimensions or chassis layout will be given other than that shown in the photographs. However, those who may wish to construct a similar unit should have no trouble in working out their own dimensions if the general parts layout shown in the various photographs is followed.

Connections are shown on the wiring diagram for the power unit, the camera mechanism and a separate a.c. power supply to replace the batteries. This power supply permits use of the unit where a.c. is available by merely pulling out the shorting plug on the front and plugging in the a.c. power unit which will then supply power in place of the batteries. The batteries need not be removed from the case. Use of such a power supply saves batteries for use where a.c. is unavailable.

While a standard auto radio power transformer and vibrator are used, it will be noted that a type 12-A tube is used with grid and plate connected together as a half-wave rectifier. Either a 12-A or 71-A may be used, but the 12-A gives slightly higher output voltage. The 12-A was chosen for its low filament current and quick heating characteristics, and also because it is so construct-

ed that it will withstand the operating voltages applied. The vibrator is the standard four-prong variety of 4- to 6-amp. capacity. Not all types of power transformers will work in this circuit as some of them will not supply sufficient output voltage, while others may be too heavy and bulky to fit the space. Note that a 6-ohm resistor is in series with the filament of the 12-A rectifier. This resistor is necessary with the 9 volts of battery as otherwise the filament of the tube would burn out.

The battery voltage was chosen because it took 9 volts to get sufficient output with the particular power transformer used. Some transformers will work with 6 or 7.5 volts; and if such a transformer is available, battery voltage may be adjusted accordingly.

### Switching Arrangement

The main control switch consists of three sections. Each section is really four separate s.p.d.t. units. In addition, there is an Off position in which all con-

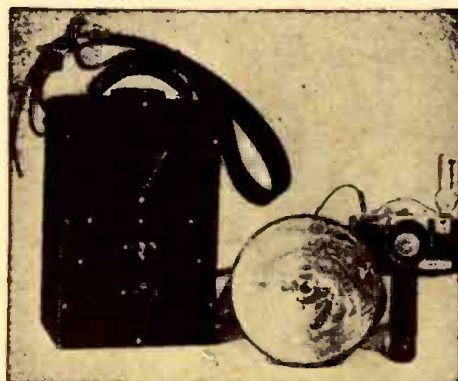

Photo D—The voltage supply, camera and lamp.

tacts are broken. This position is not shown in the diagram. There are two live switch positions. The upper switch position is Off with all units disconnected; the middle (as shown in the wiring diagram) is the Charge position, in which the capacitors are charged in parallel; and the lower is the Discharge

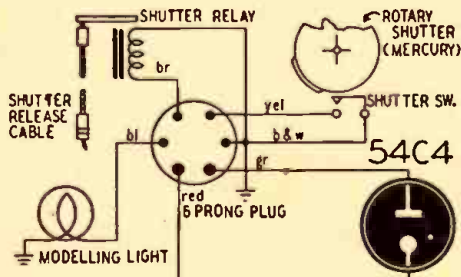

Fig. 2—Diagram of camera and lamp extension.

position. When the switch is in the lower position the capacitors are discharged in series through the flash lamp.

The flash is fired through the action of two separate relays. See Fig. 2. The shutter relay mounted on the reflector housing the flash bulb first trips the camera shutter, then the shutter trips the firing relay. This synchronizes light and shutter so that the flash occurs with the shutter wide open. The firing relay is mounted on top of the power transformer on a small piece of Lucite,

as can be seen in the Photo C, to insure adequate insulation.

The switch used to achieve the rather complicated result outlined above was

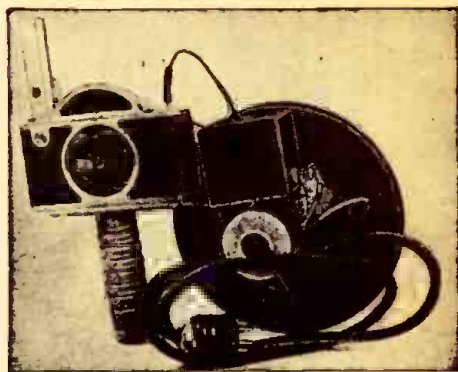

Photo E—Another view of camera and flash lamp.

assembled from Mallory sections taken from two other switches. See Fig. 3. This is not a stock item, but a two-gang switch having similar characteristics is available. Two of these units may be assembled into one three-gang switch by sawing off the spacing washers and spacing the sections closer together. It is very important to note the particular sequence to be followed in wiring each section of this switch to keep the potential differences between adjacent contacts to a minimum. Since only ten sections of the switch are used in series-parallel condenser transfer, this leaves two sections unused. One of these is used as a power switch in the primary (battery) circuit, while the other is used to switch the meter ranges from 0-15 to 0-600 volts by shifting between the two multipliers R1 and R2. The meter thus

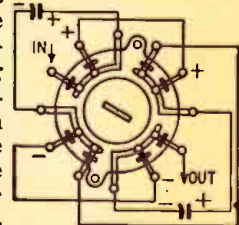

Fig. 3—Switch detail.

reads plate voltage when the capacitors are being charged, and filament voltage when the switch is in the firing position. The meter used is a war surplus item designed for aircraft use and has a luminous scale which permits operation in total darkness. This gives an indication of battery condition at all times and also serves as a warning not to leave the power switch in either the middle or lower position, which would result in rapid exhaustion of the batteries. The meter is mounted on top of the case for easy visibility, in one model.

A fuse has been included in the primary circuit. It could be omitted without affecting the operation of the unit, but it is desirable to protect the rest of the circuit in case the vibrator points should stick. About 15 amperes is the correct value.

A modeling light is built into the flash reflector to permit focusing the camera in darkness. This light is controlled by an on-off switch on the front panel of the power unit. It will be noted that it burns only when the main switch is in the Charge position. A small 6-cp minia-

(Continued on page 53)

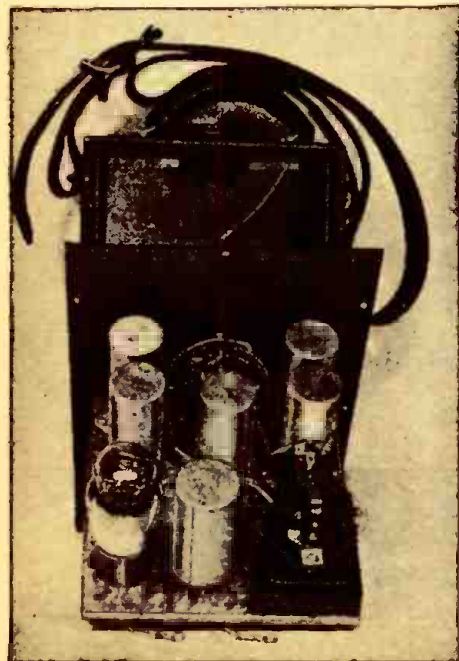

Photo C—A back-panel view of the equipment.



# TELEGUIDED MISSILES

**N**O example of American technical ingenuity is more spectacular than aircraft remote control. Begun as a plaything, it has been perfected by wartime research and now as a weapon of war it may greatly revise tactical and theoretical military thought. In common with other inventions developed primarily for war, it also will have valuable civilian use.

The use of radio-controlled airplanes early interested the Army Air Forces because of their suitability as targets. Sleeve targets towed behind other aircraft only partially performed their function: they were unrealistic and presented a hazard to the pilot of the towing aircraft, often at the mercy of an unskilled marksman.

A target aircraft, on the other hand, realistic in every detail and controlled by a pilot in another plane hovering at a safe distance, could create the proper illusion. It could supply to the airborne machine gunner, as well as the anti-aircraft gunner on the ground, with a maneuvering target to spur him on to his best efforts.

The flight-testing of new aircraft too often has seen a plane go into a power dive out of which the pilot was unable to level off. Crashing to earth the life of the pilot was not the only loss suffered. The reason for the crash often remained a mystery, concealed in the shattered fragments of the plane and the dead brain of the pilot.

Today, plans can be test-flown without pilots aboard. The most difficult flight maneuvers are accomplished by radio direction, with the reactions of the plane telemetered to the ground as they occur. If the airplane crashes, the reason is no longer secret. Valuable data has been gathered and recorded and serves as the basis for improvements in subsequent models.

During the war the Army Air Forces loaded war-weary B-17 Flying Fortresses with high explosives and purposely crashed them into high-priority German targets. Naturally no pilots were aboard. The pilotless American Kamikazes were radio-directed to their destinations by other B-17's. At that time the remote control system was not developed sufficiently to get the planes off the ground by radio. Token crews took the planes up and parachuted to safety as soon as the control planes took over.

The airplanes that flew through the atomic cloud at Bikini were controlled entirely by radio; and the data their instruments gathered has contributed to

scientific knowledge of radiation. Later, two of the planes that were used at Bikini were flown 2,600 over-water miles from Hawaii to California. Arriving off Santa Rosa Island, one of the planes dropped a smoke bomb. The flight of these two B-17's was radio-controlled from start to finish.

The various setups in which remote control may be applied to aircraft are basically similar. The channel of communication between the controlled and controlling airplanes, known as the *drone* and *mother* respectively, is a specially designed transmitter and receiver system. Controls on the drone are operated by servo motors either through the airplane's automatic pilot or directly from the transmitter. The servo motors are activated by radio impulses in accordance with the desires of the controlling pilot. Practically any maneuver within the capabilities of the plane may thus be accomplished.

A two-view television set in the drone is trained both on the aircraft's instrument panel and the outside atmosphere. By flipping a switch the controlling pilot may visually examine important dials and gages, as if he were actually in the pilot's seat of the drone.

The brains of the radio control system are incorporated in an ingenious five-pound box, known as the *beeper*, because of the bird-like sounds it emits when in

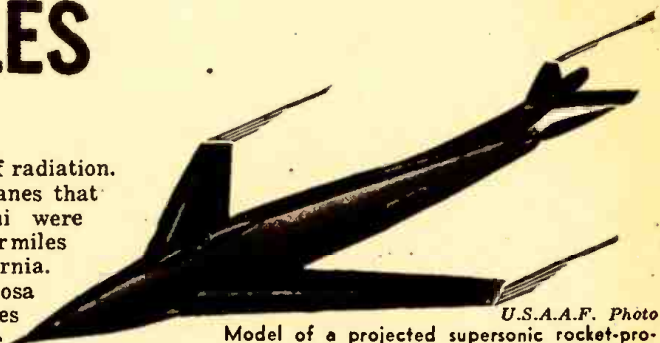

U.S.A.A.F. Photo Model of a projected supersonic rocket-propelled radio-controlled plane of the future. See illustration in "Radio Target Planes," RADIO-CRAFT, January, 1945. Levers on the box allow for any combination of plane functions, such as throttle control, raising and lowering flaps, etc.

While the range of control varies with conditions affecting radio reception, control can be achieved up to a distance of 75 miles. Usually the take-off of the drone is supervised by an operator in a jeep-installed ground station. After the drone is airborne and has climbed to an altitude of about 400 feet the mother plane takes over.

Under normal circumstances the drone's altitude is automatically controlled by altimeter equipment specially installed for that purpose. However, the altimeter setting may be over-ridden, when necessary, by a special relay box. The receiver-selector in the drone includes an eight-channel audio filter selector circuit to discriminate between the various tones received. A relay unit passes control voltages to the automatic pilot from the receiver output.

(Continued on page 56)

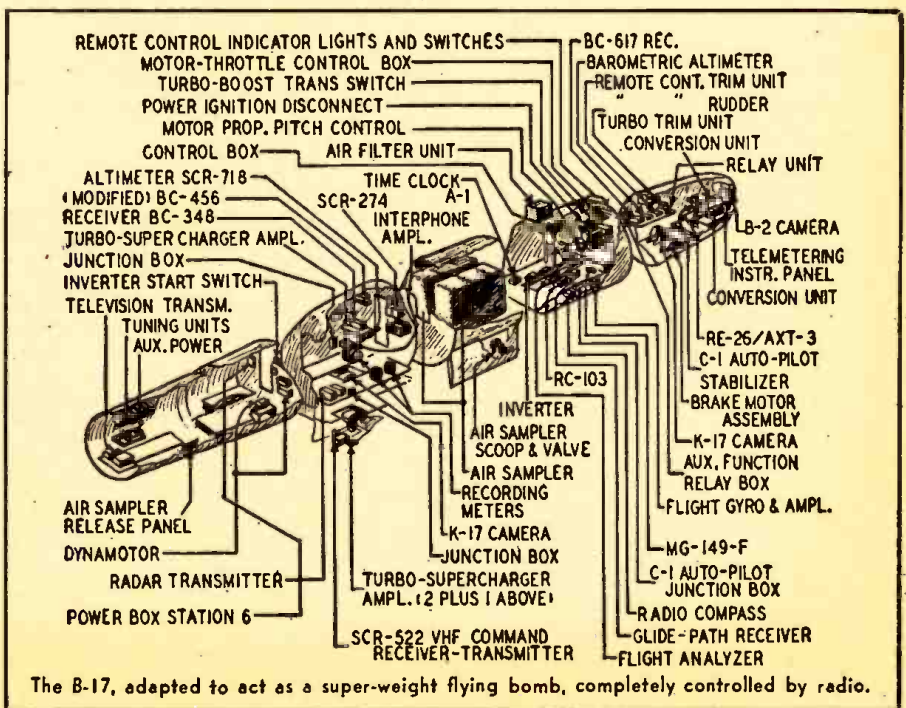

The B-17, adapted to act as a super-weight flying bomb, completely controlled by radio.

\*Information and Public Relations, Headquarters Army Air Forces, New York, N. Y.



# PROBLEMS OF INSTABILITY

By TED POWELL

ONE of the perplexing problems encountered in radio and sound work by servicemen, is circuit instability which sometimes develops in equipment which has apparently been serviced properly.

Circuit stability is governed by either of two circuit conditions, positive feedback (regeneration) or negative feedback (degeneration). Regeneration is often deliberately introduced into r.f. or i.f. amplifier circuits in controlled amounts to increase the available gain and sharpness of tuning. Similarly, degeneration may be introduced into circuits in controlled amounts to reduce hum and certain types of distortion and to suppress oscillation tendencies.

Under certain conditions, regenerative and degenerative coupling effects may exactly cancel each other out at a certain frequency or frequency range to produce extremely stable circuit operation.

## Four Kinds of Coupling

Regeneration or degeneration effects may be brought about by any of four circuit coupling factors—conduction or electron coupling; inductive or magnetic coupling; capacitive or electrostatic coupling (in the case of hyper-frequency circuits, by radiation or electromagnetic coupling) and various combinations of these coupling factors.

Conduction coupling may take place via common amplifier-tube electrode voltage-supply circuits, common grid-bias cathode-resistor circuits, common chassis ground returns, common ground bus leads, and in rare cases, via dielectric leakage paths. Although the d.c. ohmic resistances of chassis and wiring runs are measured in extremely small fractions of one ohm, their a.c. impedances are considerably greater, especially at radio frequencies.

Inductive coupling by magnetic fields around transformers, chokes and current-carrying conductors can cause considerable instability trouble in high-gain amplifiers and inadequately shielded circuits. Capacity coupling becomes rapidly more severe with increase in signal frequency. At microwave frequencies, two wire ends facing each other serve as an effective capacitance. (Two polished parallel No. 10 conductor wire ends separated by 1/10th inch, have a very small capacitance of about .00018 micromicrofarad, but at a hyper-frequency range of 30,000 mc have a capacitive reactance [a.c. impedance] of only about 3000 ohms.)

Certain design factors in electronic

control, industrial process, communication, television, navigational and radar equipment are too complex to be predicted in advance or too difficult for theoretical solution with the mathematical tools available. These complex unpredictables constitute the well-known "bugs," generally more readily handled by means of trial-and-error models and graphical methods than by pure calculation.

Persistent circuit instability results as much from mechanical arrangement and resulting stray-coupling factors as from the principal circuit constants themselves. In such cases, the usual and obvious by-pass filtering, shielding, lowering of amplifier tube electrode voltages result only in a change of overall oscillation frequency. The final alternative is to re-arrange the wiring, components and shielding on the chassis in a trial-and-error routine till the greatest freedom from stray coupling is determined experimentally.

A few simple alternatives may successfully eliminate the perplexing and involved instability "bug" when it crops up under certain favorable conditions. In multi-stage high gain r.f. or i.f. amplifiers, oscillation can sometimes be

suppressed by altering the power factor of one or two of the amplifier tube plate or screen-grid voltage supply circuits. This can be done by inserting an r.f. choke or by eliminating or changing an isolating resistor or by-pass condenser; introducing cathode degeneration by lowering or omitting the cathode resistor by-pass condenser or inserting an r.f. choke in one or two of the cathode circuits; adding or omitting some of the shielding in one or two stages; re-arranging some of the wiring, components or shielding in some of the stages; inserting r.f. chokes in series with the voltage supply busses to one or two of the amplifier stages. The power factor of the grid or plate coil or resistor load circuits of one or two of the stages may be altered by shunting them with choke, condenser and resistor networks; inserting small damping

(Continued on page 66)

Parasitic whistles, howls and "motor-boating" may be temper-ruining and time-shattering headaches to the serviceman. This article gives methods of combating this trouble.

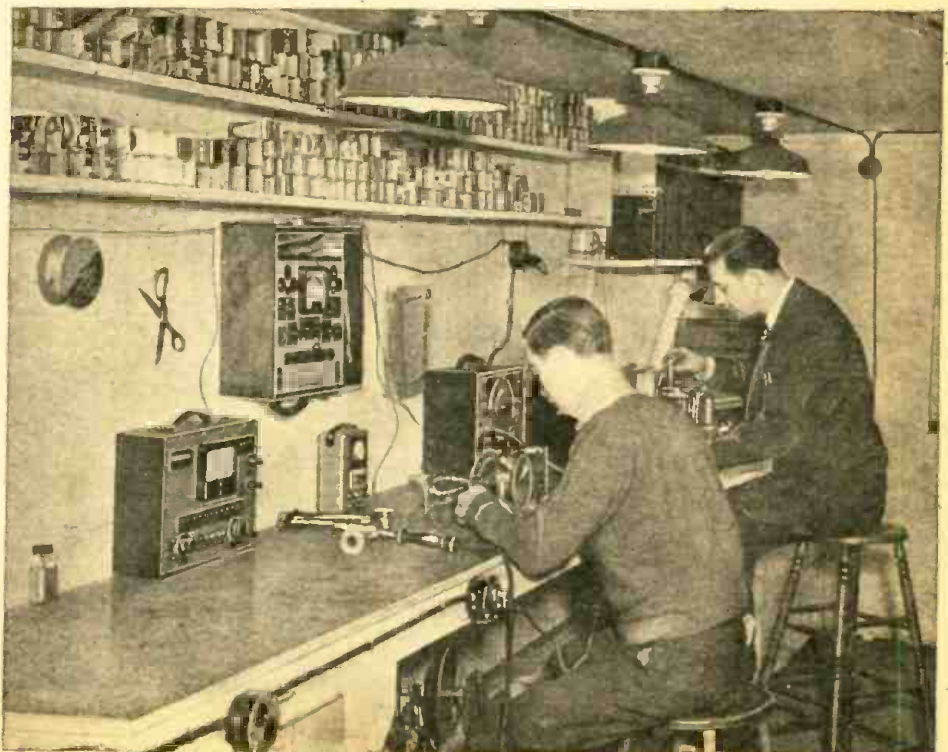

Werner's Service Shop, Binghamton, N. Y., is an example of a small but efficient layout.



# SMALL RECORDING STUDIO

## Part I — Microphone, Recorder, Turntable and Pickup

It is entirely feasible to equip a recording studio without the expenditure of a small fortune. When we reduce the prospective studio to its bare essentials, we find that we need the necessary equipment to make and playback a good recording or transcription.

These essentials would be, in the order of their importance:

1. A 16-inch dual-speed motor and turntable assembly.
2. Rugged leadscrew assembly, preferably of the overhead type, and a good cutting head.
3. High-fidelity, low-distortion amplifier with adequate power capabilities not only for recording, but also for playback.
4. High quality playback pickup.
5. Playback speaker system, preferably of the dual-speaker type.
6. One or more high-quality microphones and an acoustically treated room for the actual recording.
7. A second turntable and playback pickup for re-recording and dubbing purposes.

8. An all-wave AM receiver and an FM receiver are desirable.

It is assumed that adequate space is already available, preferably with three rooms. The recording equipment should preferably be placed in a room by itself, to insulate the recording artist from the distraction of watching the business of making a record and to insure that the attendant noises will not mar the recording.

The second space consists of the actual studio. It should contain several microphone outlets to reduce the possibility of tripping over the cord. A piano is a must, if musical recording is contemplated. The studio should be partially lined with absorbent material. One end of the studio might be so lined and the other end left reflective. This would provide a versatile arrangement where the acoustics of a large hall or outdoors may be simulated.

The third space is the reception and waiting room. There has to be a space where the clerical business of a recording studio can be conducted without

interfering with either the recordist or the artist. It would be highly desirable to provide a receptionist or secretary to meet customers.

We are, in this article, primarily concerned with the equipment necessary to make a good recording.

For this we must first have a turntable and motor assembly. The selection of this item deserves our deepest consideration. It is possible to cut corners nearly everywhere else, but *we cannot turn out good recordings with a poor turntable*. It must neither introduce wow (which is a change of speed within one revolution) nor slow down under the pressure of the cutting head. Both of these deficiencies will be noticeable to even the most uncritical customer. Wow is greatly reduced in a turntable that has great mass. Sixteen-inch tables usually are made of cast iron and weigh from twenty to fifty pounds. The drive motor should have adequate power, so as not to slow under the load of the cutter, and should have a continuous-duty rating of at least 1/30 horsepower.

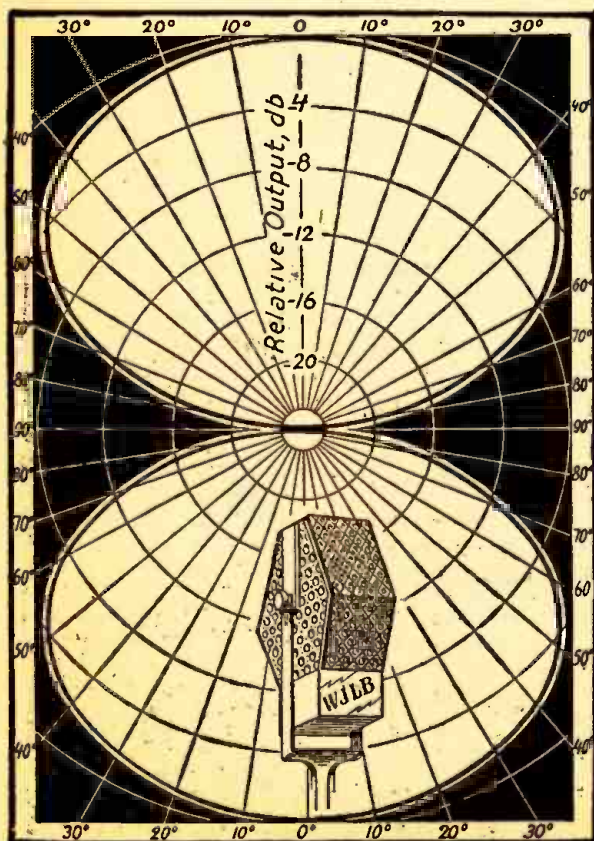

Courtesy Brush Development Co.



Courtesy Amperite Co.

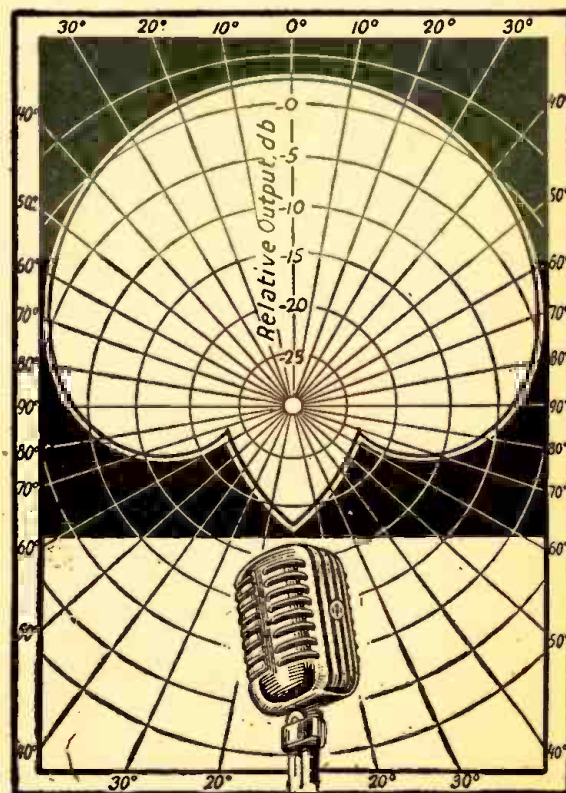

Fig. 1, left—Velocity microphone and typical field pattern. Right—Cardioid field pattern with representative microphone of this type. Top photo—Non-directional sound cell microphone; bottom—standard dynamic type.



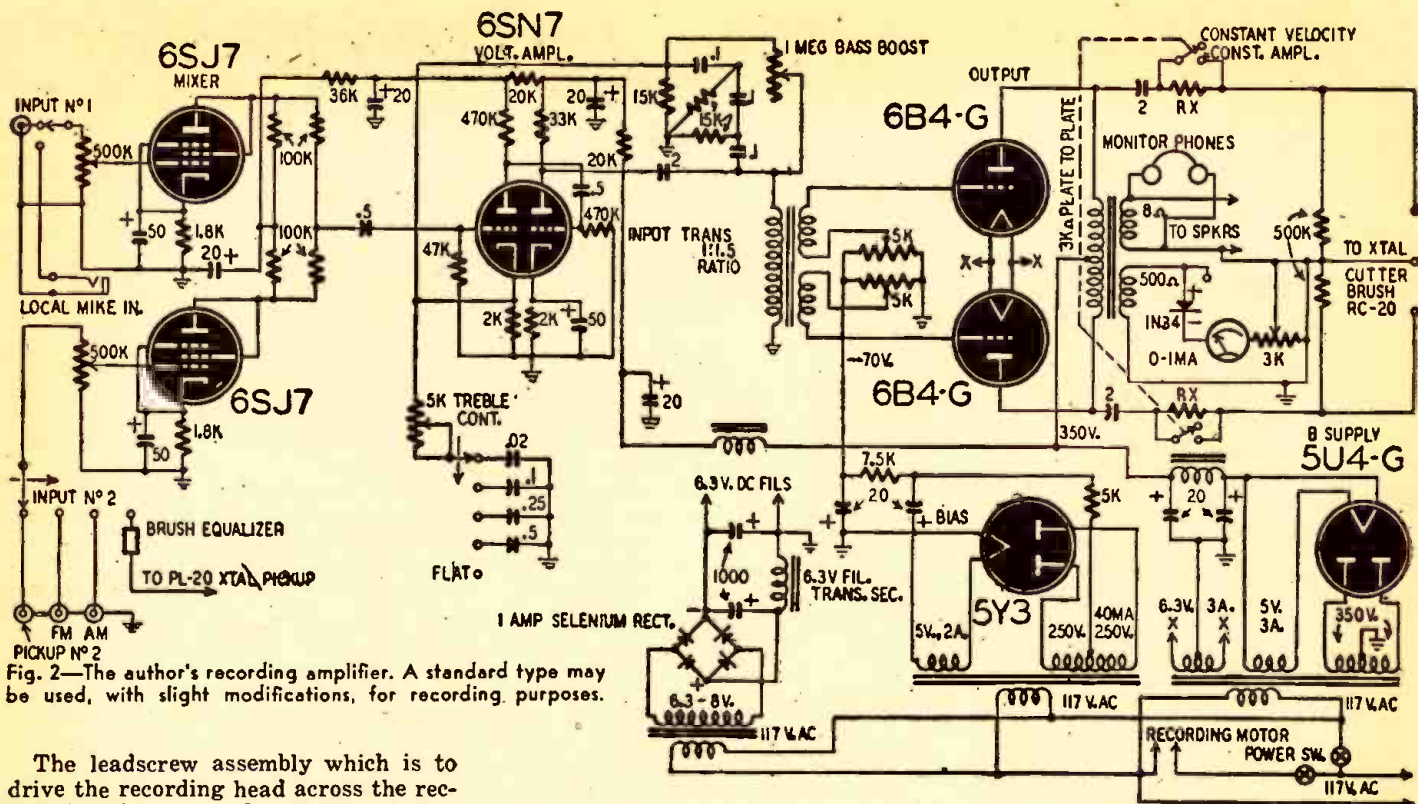

Fig. 2—The author's recording amplifier. A standard type may be used, with slight modifications, for recording purposes.

The leadscrew assembly which is to drive the recording head across the record should be rugged and without play of any kind. The overhead type is usually preferable.

There are many cutting heads to choose from. They range from six dollars to several hundred. There can be no doubt that when cost is a factor, the crystal type will provide the best results. It is equally certain that the finer magnetic types will provide the very best quality.

The next most important item is our amplifier. It should be of the highest quality you can afford. In the interest of economy, it might be well to construct your own.

This amplifier should provide several channels feeding a stage containing high- and low-frequency compensation, which, in turn, feed an output stage capable of at least ten or fifteen watts at a maximum of two percent distortion. Switching should be provided for several recording characteristics. Means should also be provided to monitor the output of the amplifier. An a.c. voltmeter, with a flat frequency response and plainly marked as to the maximum level that may be safely applied to the record, should be permanently connected to the amplifier's output. Also, it is desirable to provide audible monitoring by headphones or speaker.

A suitable playback pickup must be provided. Again, there are many choices. The crystal types provide the best performance when cost is a prime factor. The magnetic and dynamic types cost much more, but can have wider range and lower distortion. In the interest of simplicity of compensation, it is desirable to use the same type of cutter head and playback pickup. It is significant that the average user of 10- and 12-inch records will use a crystal pickup, whereas the user of 16-inch transcriptions usually uses a magnetic or dynamic type. There is a profound difference in

the recording characteristic, which should be taken into account when the recording is made.

A high-quality playback speaker in a good baffle is a necessity to do justice to the playing of your best recordings. An extended-range eight-inch speaker in a bass-reflex baffle is offered by at least one large manufacturer for less than twenty-five dollars, although the more expensive coaxial types would be more desirable. The minimum requirement of the speaker system is that it be reasonably flat from 50 to 8000 cycles, and it would be desirable to have the range flat from 40 to 12,000 cycles per second.

It would be desirable to provide a duplicate 16-inch turntable and overhead system so that continuous recordings could be made. In the event that

the cost is prohibitive, a good 12-inch dual speed turntable, together with a pickup suitable for playing 16-inch records, can be used for dubbing and copying. It is essential that this turntable be free of wow and speed variations.

We will need several microphones. The types selected will depend upon their intended use. For music, a velocity type is considered good. Superb, also, are the several cardioid types and the sound-cell crystals. For voice recording, the crystal and dynamic types are preferable. The crystal types are the most inexpensive in original cost.

Several different pickup patterns are available in the different types and the microphones should be chosen with this pattern in mind. Fig. 1 shows the pick-

(Continued on page 52)

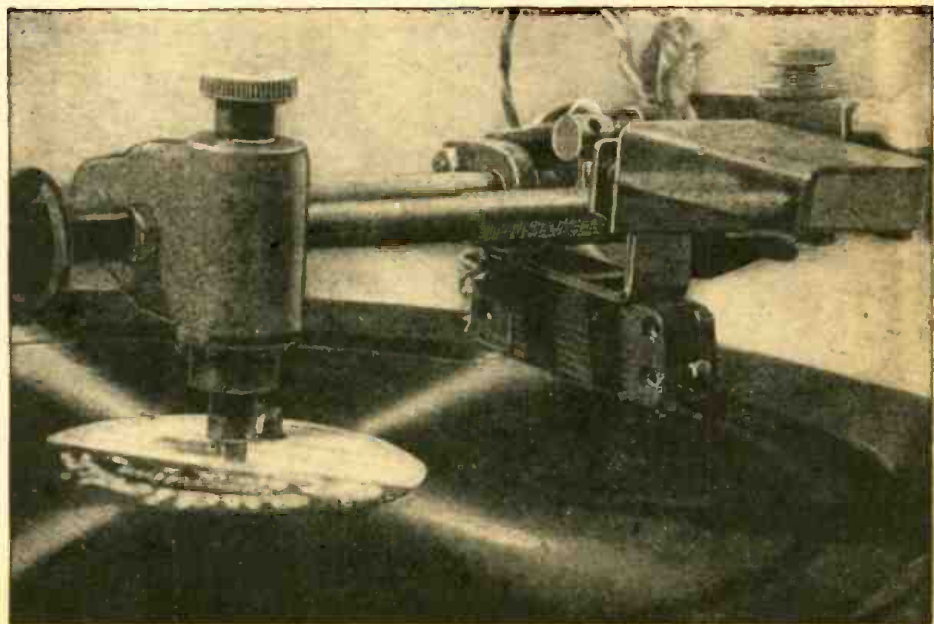

Heart of the recording assembly. Sturdiness and freedom from any play are important here.



# BUILDING A TELEVISER

## Part II—The Sound Section Is a Good FM Receiver

**T**HIS receiver is the sound section of the televiser described in last month's issue. Full winding data for all tuning coils as well as audio and video i.f. transformers are given in this article. The set may be used as a straight FM receiver on the new channels if slightly modified. Notes on winding coils to cover these channels are included here.

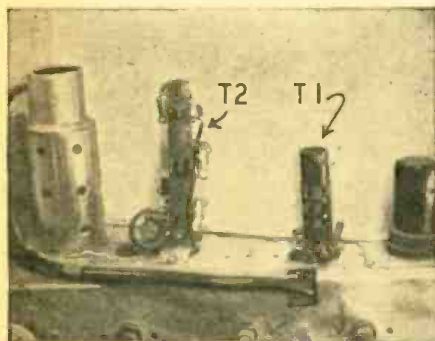

Photo A—The composite and video i.f.'s.

The oscillator feed-back coil L13-P14 (Fig. 1) consists of a 1-turn primary and 1-turn secondary, each  $\frac{5}{8}$  inch in diameter. Both coils are wound with

No. 14 wire. A piece of spaghetti tubing is slipped over each coil, and they are coupled as closely as possible.

The oscillator coils L10, L11, and L12 are wound with No. 14 enamel wire as follows: L10, 6 turns; L11, 4 turns; and L12, 1 turn.

All the coils are self-supporting,  $\frac{1}{2}$ -inch in diameter, and spaced as required to hit the desired band.

The mixer grid circuit coils are wound as shown in Fig. 2. Winding data follows:

Coils	Turns	Wire Size
LA (L1, L4, L7)	1	No. 14 enamel
LB (L2, L5)	4	No. 26 enamel
(L8)	2	No. 26 enamel
LC (L3)	4	No. 26 enamel
(L6)	3	No. 26 enamel
(L9)	2	No. 26 enamel

Coil LA is center-tapped.

Position 1 of SW2 covers channels 1 and 2; position 2, channels 3 and 4; position 3, channels 5 and 6.

Construction of the video and sound i.f. transformers is perhaps the biggest task in building the set. The second,

third, and fourth video i.f. transformers are constructed and wired as shown in Fig. 3-a. The windings and condenser values are:

LA (L18, L21, L24);	23.5 turns, No. 30 enamel
LB (L19, L22, L25);	41 turns, No. 30 enamel
LC (L20, L23, L26);	same as LA
CA (C22, C24, C31);	3-25 $\mu$ f variable
CB (C18, C26, C33);	3-25 $\mu$ f variable (Set approx. 22 $\mu$ f)
CC (C19, C27, C34);	3-25 $\mu$ f variable

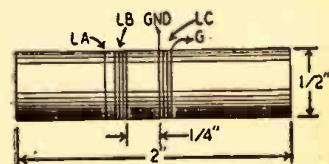

Fig. 2—Winding details of mixer grid coils.

The first, fifth, and sixth video i.f. transformers are constructed as shown in Fig. 3-b. The coil winding data are:

Coils	Turns	Wire Size
LA (L16, L29, L32)	21	No. 28 enamel
LB (L15, L27, L30)	29	No. 32 enamel
LC (L17, L28, L31)	23	No. 32 enamel

V1, MIXER, V20, V21, I.F. AMPLIFIERS, 6AC7  
V22, LIMITER, 6SJ7 V23, DISCRIMINATOR, 6H6

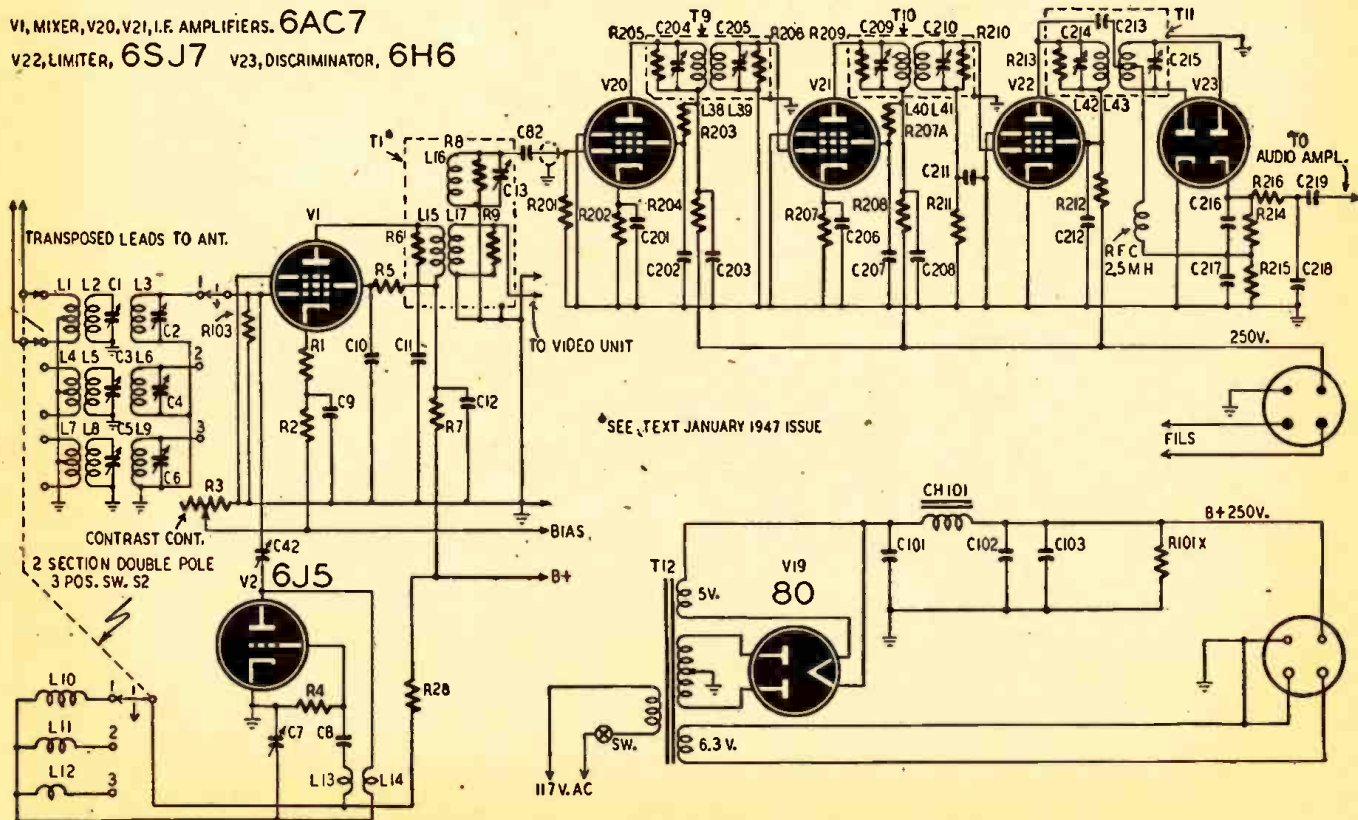

Fig. 1—Complete sound section of the television receiver, including the mixer section which was also printed in last month's figure.



The construction and placement of T1 and T2 are shown in Photo A.

The sound i.f. and discriminator transformers are wound on 1/2-inch forms with the windings spaced as shown in Fig. 3-c. The primary windings L38, L40, and L42, and the secondary windings L39, L41, and L43 are all wound with 23 turns of No. 32 enamel wire. L43, the secondary of the discriminator transformer T11, is center-tapped. All of the video and audio i.f. transformers are mounted in standard, shielded i.f. transformer cans.

Air trimmers are recommended for the i.f. and discriminator transformers; however, mica trimmers may be used if desired.

The peaking coils L33, L34, L35, L36, and L37 for the detector and video amplifier circuits may be purchased commercially in the proper value, or they may be wound. The coils are wound as follows: L33 and L35, 280 turns; L34, 155 turns; L36, 230 turns; and L37, 110 turns. All coils are wound on 1/2-inch bakelite forms with No. 38 enameled wire. To insure wide-band operation from the video detector and amplifier stages, the lead capacitance should be kept to a minimum.

The vertical oscillator transformer T7 is wound on an iron core salvaged from a small a.f. transformer or a.c.-d.c. filter choke. The outside of the core measures approximately 1 1/2 inch on each side. The center leg is about 1/2 x 1/2 x 3/4 inch. Both windings are wound in the same direction with No. 32 enamel wire. The primary has 100 turns and the secondary has 200 turns. Wiring connections are shown in Fig. 4.

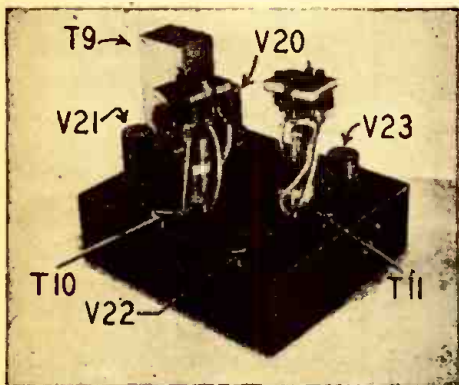

Photo B—Construction of i.f. transformers.

### Wiring Notes

When wiring the i.f. stages, all ground connections for one stage should be returned to a common point. Care should be taken to isolate each stage. Good quality carbon resistors should be used and connections should be well soldered to keep circuit noise to a minimum. Noise developed in the video circuits will make the picture appear grainy.

Precautions should be taken to keep 60- and 120-cycle hum out of the picture by placing wires carefully. Hum picked up in the video circuits will appear as black bars across the picture, while hum picked up in the sweep circuits will cause a wavy edge on the raster. The grid lead to the picture tube should be as short as possible. A lead 10 to 12

inches long, if properly isolated from magnetic fields, should give no hum pickup.

Construction details for the sound unit i.f. and discriminator transformers are shown in the photograph of the sound unit (Photo B). The sound i.f. signal is fed from the mixer to the sound unit through a length of 72-ohm co-axial cable. The audio output from the sound unit is sufficient to drive the phonograph input circuit of any average broadcast receiver. If desired, the builder can add his own audio stages.

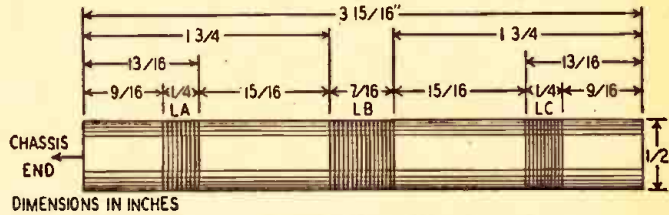
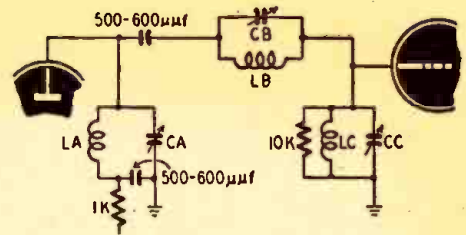

Fig. 3-a—Winding details for T2, T3 and T4.

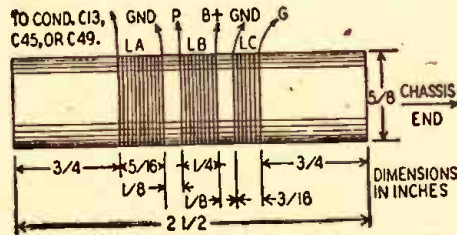

Fig. 3-b—Winding details for T1, T5 and T6.

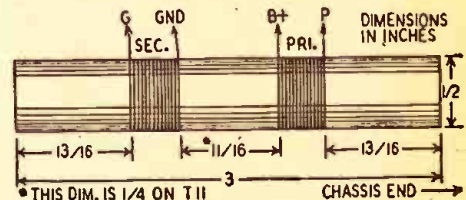

Fig. 3-c—The sound i.f.'s and discriminator.

### Alignment of the Sound Receiver

The alignment of the receiver is somewhat difficult and, for accurate results, requires equipment not readily available to the average builder. The alignment method described here is long and rather tedious but yields good results.

The following equipment will be required: a calibrated r.f. signal generator capable of covering the range from 8 to 20 mc; if possible, an r.f. signal generator to cover the range from 44 to 88 mc; a 0-1 milliammeter; and an oscilloscope or v.t.v.m. for output indicator. Both signal generators should have provision for modulation of the signal (about 400 cycles), and the output should remain substantially constant over the frequency range to be covered.

The sound unit should be aligned first, since it will be used later in the final adjustment of the receiver. Insert the milliammeter between the lower end of the limiter grid resistor R211 and ground. Feed an 8.25-mc r.f. signal into the grid circuit of V20 through a 50-microfarad capacitor. Adjust the trimmers on transformers T9 and T10 for maximum indication on the meter. Throughout the alignment always use the minimum output from the signal generator that will give a readable signal on the output indicator. Rock the signal generator 100 kc each side of 8.25 mc, and note the reading on the meter. The output of the sound unit should remain fairly constant over the 200-kc band width. If it does not, readjust the trimmers on the transformers while rocking the signal generator through the 200 kc until a fairly constant output is obtained over the tuning range.

Remove the meter and reconnect R211 to ground. Insert the meter in series with R214 in the output of the discriminator circuit. Set the signal generator

to 8.25 mc and adjust the trimmers on transformer T11 for resonance which will be indicated by zero reading on the meter. Next set the signal generator to about 8.35 mc, and note the meter read-

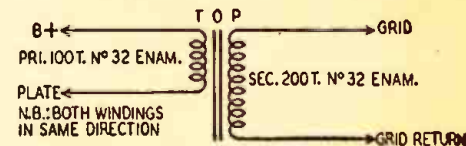

Fig. 4—The vertical oscillator transformer.

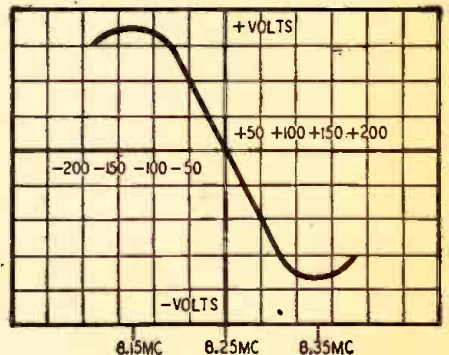

Fig. 5—The ideal discriminator tuning curve.

ing (reverse connections to the meter if the reading is downward). Set the signal generator to about 8.15 mc, and again note the meter reading. The two readings should be the same. If they are not, readjust the primary trimmer C214. After readjusting C214 check to see that the meter reading is zero at 8.25 mc. In general, C215 will affect the zero response frequency while C214 will affect the symmetry of the discriminator peaks. A cut-and-try adjustment of both trimmers will produce a satisfactory curve similar to Fig. 5.

Remove the meter and reconnect R211. Remove the signal generator and connect the sound unit to the main receiver chassis (i.f. co-axial line). Connect the output of the sound unit to an

(Continued on page 62)



# HAM STATION FROM SURPLUS

## How to Convert the No. 19, Mark II, to A.C. Operation

THE No. 19, Mark II, receiver and transmitter set, a popular piece of radio equipment among experimenters and amateurs, is readily available on surplus radio markets. It was built for use in Russian and British tanks (dial and panel markings are in Russian and English) and is designed to be powered from a 12-volt vehicular storage battery. The entire unit may be obtained complete with microphones, headphones, diagrams, and other accessories. The purchaser should be especially sure to obtain the schematics—they are too large to reproduce here. By constructing suitable a.c. power sup-

plies, the owner of the Mark II may adapt it for fixed station operation if he desires.

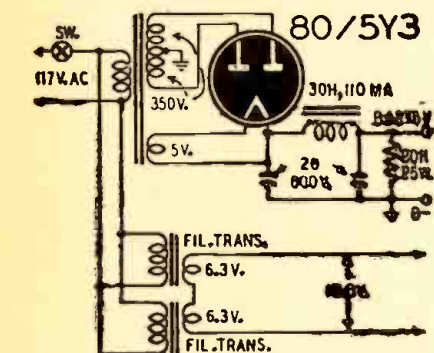

Fig. 1—The low-voltage power supply section.

plies, the owner of the Mark II may adapt it for fixed station operation if he desires.

The Mark II is essentially three units in one. Set A is a complete 2- to 8-mc voice and c.w. transmitting and receiving station covering the 80- and 40-meter amateur bands. The transmitter has a power output of 30 watts c.w. and 5 watts voice. The transmitter uses a m.o.p.a. circuit with the frequency control ganged to the tuning control of a 5-tube superheterodyne receiver. Set B is a 4-tube transceiver tuning from 230 to 240 mc, thus covering the 235- to

240-mc amateur bands. Set C is a 2-tube interphone amplifier using a 6K7-G and a 6V6-G.

The transmitter of Set A uses the hexode section of a 6K8-G, V2B, as a variable-frequency oscillator working into an EF50 buffer amplifier. The final amplifier is an 807. The 6H6 is used as an automatic drive control rectifier and meter rectifier. The receiver uses a 6K7-G r.f. amplifier, 6K8-G oscillator-mixer followed by two 6K7-G i.f. stages and a 6B8-G detector, a.v.c. and a.f. amplifier. The pentode section of the 6B8-G is the modulator for radiotelephone transmission and as the tone oscillator-modulator for m.c.w. The triode section of V2B is the b.f.o. when receiving c.w.

Set B consists of an E1148 high-frequency triode, two 6K7-G's, and a 6V6-G. When transmitting, the E1148 is a v.h.f. oscillator modulated by the output of the 6V6-G. The 6K7-G, V1E, is used as the microphone preamplifier. When receiving, the E1148 is supplied with a 158- to 228-kc quench voltage generated by the 6K7-G, V1D. The 6K7-G and 6V6-G are a.f. amplifier and power amplifiers, respectively.

The interphone amplifier (Set C) has a 6K7-G speech amplifier driving a 6V6-G power amplifier.

The set may be operated from 117-volt a.c. lines by using three small power supplies and making two minor changes in the control circuits. The power supply in Fig. 1 delivers 275 volts at 110 ma to operate all tubes except the 807 power amplifier of the transmitter. Two 6.3-volt 4-ampere filament transformers are connected in series-aiding to provide 12 volts a.c. for the tube filaments. Regulation of the high-voltage section of this supply must be good because the stability of the variable-frequency oscillators depends upon constant voltage.

The power-amplifier plate supply is shown in Fig. 2. It delivers 500 volts with a load of 50 ma. Since the current required is comparatively low, regulation may be improved by using a heavy bleeder across the high-voltage output.

The circuits are switched from receive to transmit by control relays L19A and L19B in Sets A and B, respectively. These

relays must be operated from a 12-volt d.c. supply. The a.c.-d.c. supply shown in Fig. 3 uses a 117Z6 in a half-wave rectifier circuit. Its output is tapped to supply 12 volts d.c. for the relays. (This supply may be replaced by two 6-volt Hot-Shot batteries connected in series. They will last for months. The current drain is only 120 ma.)

### Circuit Alterations

— The blue wire, connected between relay L19A and the filament pin of the 807, V4A, is disconnected at the socket.

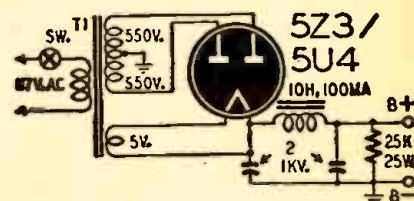

Fig. 2—Power supply for the amplifier stage.

The blue lead with black tracer is disconnected from the No. 7 pin of the 6K7-G, V1E. These loose ends are soldered together and brought out to a

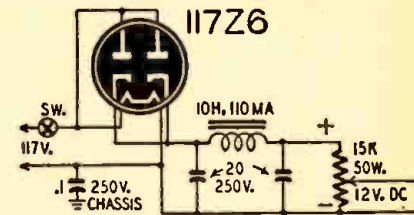
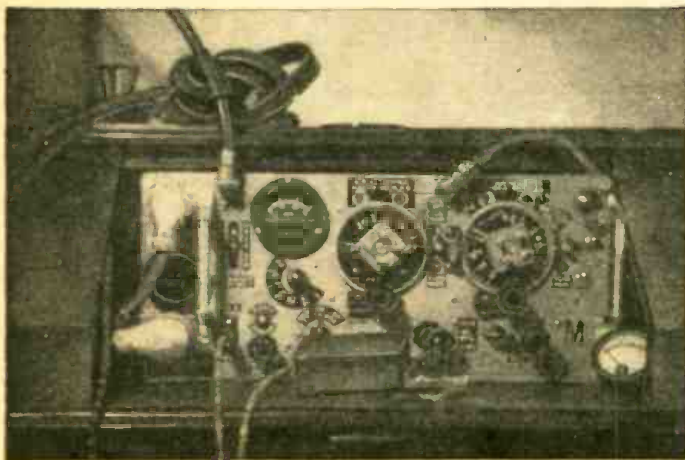

Fig. 3—A 12-volt rectifier-type bias supply.

binding post on the front panel. The positive side of the 12-volt d.c. supply is connected to the binding post.

The negative side of the d.c. supply is connected to the chassis of the set. (This supply should be polarized so that the grounded side of the a.c. line is always connected to the chassis of the set. —Editor)

The receiver section may be improved for amateur operation by providing manual r.f. gain control and including a switch to ground the a.v.c. line when receiving c.w. signals. These changes may be made by comparing Fig. 4 with the original schematic that accompanies the set. The cathode resistors of V1A and V1B are disconnected from ground and tied to the arm of a 20,000-ohm potentiometer. One leg of the control is connected to ground so that the r.f. gain increases as the control knob is turned clockwise. The a.v.c. line may be grounded by connecting a switch between the junction of L10A and R8B and ground. When the switch is open, (Continued on page 80)



A front view of the No. 19, Mark II. The markings are bilingual.



# TELEVISION FOR TODAY

## Part IX — D. C. Reinsertion and Image Synchronization

**A**NALYSIS of the video signal (in a preceding article) indicated that it consists of two parts: an a.c. and a d.c. component. The a.c. component governs the variation in detail from point to point, whereas the d.c. component governs the over-all background illumination of the received image. We may look upon this latter component as an over-all intensity control, automatic in the receiver, but adjustable at the broadcast studio according to the dictates of the production manager. The transmitted and received signals contain this d.c. component and it is only in the output of the second detector when the r.f. has been removed that we need give it special attention. This becomes evident when we consider the nature of the video amplifiers that follow the video detector and the form of the video signal.

Video amplifiers are coupled by means of condensers. The d.c. component is automatically eliminated in passage. Fig. 1 compares the forms of the video signal with and without the d.c. component. In one instance, Fig. 1-a, the synchronizing pulses are on one level and the three degrees of intensity (white, grey, and dark) are properly oriented with reference to the top-most or black level. In the second illustration, Fig. 1-b, the d.c. component has been removed and the synchronizing pedestals are no longer aligned to one level. Without the d.c., the wave

adjusts itself so that the areas above and below the zero reference line are equal, this being true of all a.c. waves.

What would be the effect of a missing d.c. component upon the final image? First, there would be no exact way of determining what the true average background brightness is, since this is a direct function of the d.c. component. Imagine two studio scenes, alike in every detail except the over-all lighting. Assume that one scene is strongly illuminated while the general illumination on the other is low. Examination of the resulting video signal would reveal that they differed substantially only in the amount of d.c. component contained in each. The illustration in Fig. 2, might very well present this situation.

With no d.c. component, both the above signals produce essentially the same image, with an average background illumination based primarily upon the various shades of the people, their clothing, and the objects in the image.

As a general statement, the d.c. component controls the image sensation more in the regions of high brightness, while the a.c. component produces a greater effect in the low intensity region. Hence, removal of the d.c. component will produce a darker image.

Secondly, with the removal of the d.c. component, the blanking and synchronizing pulses are no longer aligned to

the same level. The purpose of the blanking pulses is to drive the control grid of the cathode-ray tube to cut-off. However, with the pulses at various levels, it becomes necessary to bias the cathode-ray tube (with the brightness control) to such a value that most blanking pulses, in their new position, cause cut-off.

Finally, every cathode-ray tube has a certain characteristic curve. For a definite input voltage, a certain beam current is obtained and a related amount of light appears on the screen. To obtain repeated appearances of any one shade requires the application of the same voltage each time. This is not possible unless one reference level is used throughout. It is here that the d.c. component is useful. By reinserting this voltage, all blanking and synchronizing pulses are maintained at the same level and the associated image detail is likewise oriented correctly.

### Reinserting the D.C.

The d.c. component may be reinserted, if it has been removed, because removal of this component does not alter the shape of the video signal, but merely its reference level. Re-examine Fig. 1. If we could somehow raise each synchronizing pulse of the a.c. video signal back to the same level, then the video detail electrically associated with that pulse would likewise readjust itself.

Two methods are in common use for d.c. reinsertion. Both develop a variable bias which, when placed in series with the video signal, replaces the previously lost d.c. component. The simplest circuit is shown in Fig. 3. The d.c. reinsertion (required only in the final video amplifier) is obtained from the combination of zero cathode potential plus grid-leak bias.

The signal applied to the grid of this last amplifier is in the negative picture phase for proper orientation at the cathode-ray tube. In this form each synchronizing pulse possesses the most positive potential of its line. This is very important, for on it depends the operation of the d.c. reinsertion network,  $R_g$  and  $C_c$ . The tube has no bias other than that which appears across  $R_g$ , and the voltage at  $R_g$  is directly dependent upon the synchronizing pulses. At each pulse the grid draws current and charges  $C_c$ . The condenser then discharges through  $R$  at a rate dependent on the time constant  $T=R_g \times C_c$ . By designing the network with a time constant equal to or slightly greater than one horizontal line, we can force

(Continued on page 72)

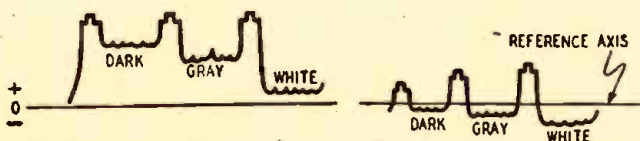

Fig. 1—A.c. and d.c. forms of a video signal (negative picture phase).



Fig. 2—These two video signals are alike except for their d.c. level.

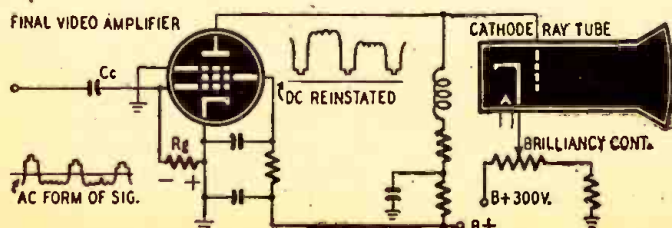

Fig. 3—In this circuit,  $C_c$  and  $R_g$  are the d.c. reinsertion components.



# SIMPLE MODULATION METER

## A Simple Method for Obtaining Diverse Information

**M**ANY modulation indicators have been designed, but few have the overall simplicity and accuracy of the cathode-ray tube for discerning waveform, percentage of modulation, or deficient operation.

The simplest modulation indicators employ either a diode tube, meter, or neon lamp. These systems generally indicate over-modulation only. Special meter circuits may be employed to read in percentage, but these are generally expensive.

The use of a cathode-ray oscilloscope to check percentage of modulation is not new, many texts describing the familiar trapezoidal patterns produced when the r.f. and audio signals are combined properly in the instrument.

The equipment required for these modulation tests is any standard cathode-ray oscilloscope and a plain antenna or t.r.f. shortwave receiving coil. Where a commercial oscilloscope is not available, it is possible to build a simple modulation oscilloscope for relatively little expense. Such an oscilloscope is shown schematically, with this article (Fig. 1). Only three radio tubes plus the cathode-ray tube are required. Power supply requirements are simplified by the use of one conventional mid-get radio power transformer. Half-wave rectification is used to supply the high voltage for the cathode-ray tube. Use of half the transformer to supply the high-voltage d.c. for the sweep circuit is a novel innovation, but perfectly satisfactory and free of ripple where sufficient filtering is used. The sweep circuit employs a high-vacuum tube which is inexpensive as compared with any of the gas-filled tubes normally used in these circuits. The connection between the sweep circuit and the cathode-ray tube control grid is to eliminate the flyback sweep trace on the face of the cathode-ray tube. Normally synchronism of the sweep is not required, but input connections are shown on the drawing, indicating where part of the audio signal may be fed if sync is desired.

Positioning controls are not required for centering the trace. Manufacturing tolerances center the beam within a short distance of the screen center. If the trace is not centered properly, look first for a leaky coupling condenser between the sweep circuit and the deflection plate. This condenser must show 20 megohms or higher, and for this reason it is often wise to use a mica condenser in this section of the circuit. A loudspeaker too close to the cathode ray tube may deflect the cathode-ray beam mag-

netically. To check these troubles, short the deflection plates to ground; if this clears up the trouble, it is in the circuit, probably due to application of a d.c. potential (as through a leaky condenser) to the deflection plates. Where this does not clear up the trouble suspect magnetic fields. Check the surrounding area with a small compass. Iron panels or the very deflection plates in the cathode ray tube may be magnetized. These

ground. It may be found impossible to use the three-inch oscilloscope (because of a grounded deflection plate) except with single-ended transmitters. It is imperative when using the five-inch or larger cathode-ray tube to use pushpull deflection as previously mentioned; failure to do so will result in a keystone

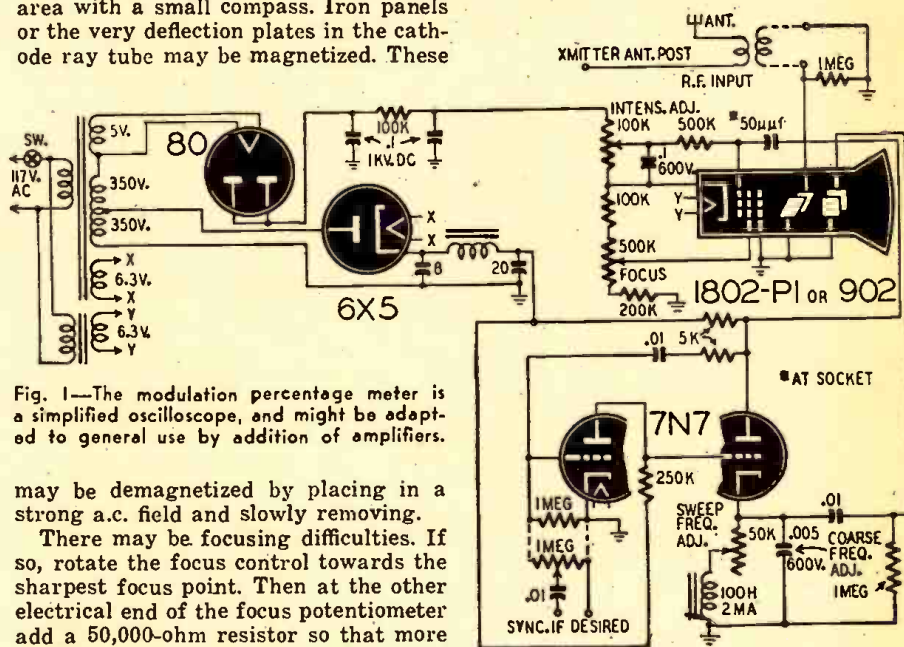

Fig. 1—The modulation percentage meter is a simplified oscilloscope, and might be adapted to general use by addition of amplifiers.

may be demagnetized by placing in a strong a.c. field and slowly removing.

There may be focusing difficulties. If so, rotate the focus control towards the sharpest focus point. Then at the other electrical end of the focus potentiometer add a 50,000-ohm resistor so that more voltage will be available in this direction. Follow up by backing off the control until focus is obtained.

The primary side of the r.f. pickup coil is connected to the antenna post of the transmitter. Normally the loading resistor or antenna is connected to the other (unconnected) side of the primary coil so that it is in series, effectively, with the antenna lead coming from the transmitter. This primary coil should not be at a current node, but the exact location is not critical, there being nothing to balance or adjust to cause the indicator to show the correct percentage of modulation. Where the transmitter power is high, the primary winding may be connected through a small isolating condenser from the antenna post to ground.

The secondary of the coil should be connected directly to the vertical deflection plates of the cathode-ray tube, with all else (including the positioning control) disconnected. If the oscilloscope tube is five inches or over, pushpull deflection (to be preferred) will be available. Here the secondary of the coil is center-tapped (not critical) with the outside connections going directly to the deflection plates and the center tap to

pattern with possible indications of unsymmetrical operation although it does not exist.

There are two reasons for connecting the secondary of the r.f. pickup coil directly to the deflection plates. The vertical deflection amplifier in standard oscilloscopes does not amplify much over 200 kc and thus is incapable of amplifying the radio-frequency signal. It is advisable to disconnect the oscilloscope amplifier output tube from the deflection plates to reduce tube and wire capacities to ground. Modern oscilloscopes have disconnect links exposed on the back of the unit for direct connection into the deflection plates, making wiring changes unnecessary. When hooking directly into the deflection plates, the vertical positioning control is inoperative. If the beam trace is too far from the center of the tube with this control disconnected, it is possible in some cases to reconnect it and unwire the output tube connections to the deflection plates. Where positioning is obtained through the output tube by control of plate current, this is not possible.

(Continued on page 58)



# ANTENNA PRINCIPLES

## Part III—Directional Arrays and Radiation Fields

PREVIOUS articles described the operation of simple antenna systems suitable for broadcast reception and amateur operation. More elaborate designs are used for commercial communication and broadcast transmission.

All practical antenna systems and arrays are directional to some extent. They may be grouped in accordance with their characteristics as follows:

1. Those designed to receive or transmit along one or a few narrow beams only. In other directions the system is relatively ineffective.
2. Those producing an irregular pattern.
3. Arrays having circular patterns in the horizontal plane. Actually these types are directional with little propagation upward or downward, but they are commonly termed *nondirectional*.

### Beam Arrays

For point-to-point communication there are many advantages in using an antenna which concentrates power in desired directions only. Secrecy is maintained and very high efficiency is possible. Interference with and from other transmissions is reduced to a minimum. Sharp beams become practical at the higher frequencies because the radiating systems can be constructed within a reasonable area.

The Amphenol broadside array is an example of a well-designed communications antenna for the 152-162 mc band. These frequencies are assigned to fire departments, police, press, and railroads. The same array also can be used (with slightly lower efficiency) in the neighboring amateur and government bands which extend from 144-198 mc. Its excellent directional characteristics recommend it for fixed or mobile point-to-point service.

The electrical design of the Amphenol broadside array is illustrated in Fig. 1. Four half-wave dipoles are spaced by one-half wavelength and fed at their centers. The feeder system from the array may use RG8U or (for very long lines) RG17U co-axial cable.

The large-diameter tubing lowers the inductance and raises the capacitance of each dipole. The low Q broadens the response curve and accounts for the very wide band over which the antenna is effective. Use of low-impedance cable eliminates difficulty with voltage loops and leakage. Note that the outer dipoles are fed through cables which are one full wavelength longer than the cables which feed the inner ones. Therefore each dipole is fed *in phase*.

Power is propagated only broadside to the array. Assume that a wave starts out at some instant from one dipole. It reaches the next dipole one-half cycle later because of the half-wave spacing. At this later instant the second dipole tends to radiate a field which is out of phase with that which has just reached it from the other. The two opposite fields cancel out along either direction of the array. A receiving antenna located broadside to the array intercepts equal power from each of the four dipoles since in this case all currents are in phase. The total gain in the second case is 7 db over that of a single radiator.

The narrow fields which are possible with the broadside array are shown in Figs. 2-a and 2-b. The first is a cross-sectional view as it might be seen by an observer standing on a level with the array (if radio waves were visible). Little power is lost through upward

propagation. The second figure is a view looking down on the antenna.

A sharper beam can be transmitted by using a still more complex array.

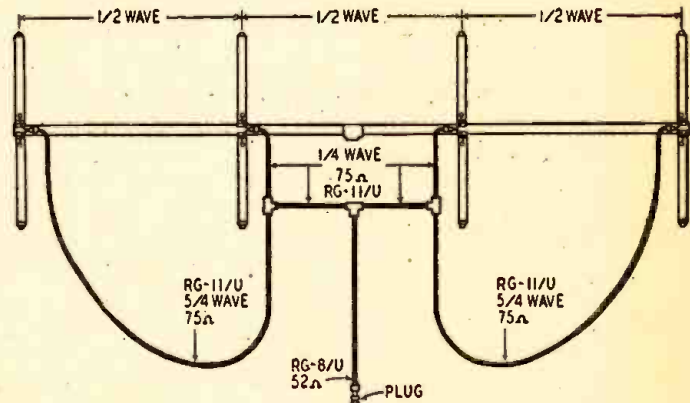

Fig. 1—This array consists of four dipoles operating in phase.

Photo A shows such a system. This particular antenna is erected above the forty-third story of the building which houses WOR's FM station WBAM, more than 500 feet above street level in the heart of New York City. It has an effective gain of 60!

This array is beamed toward Washington, D. C., and can be used for transmitting at 47.1 or 106.5 mc. The interesting antenna is of the same type as

(Continued on page 55)

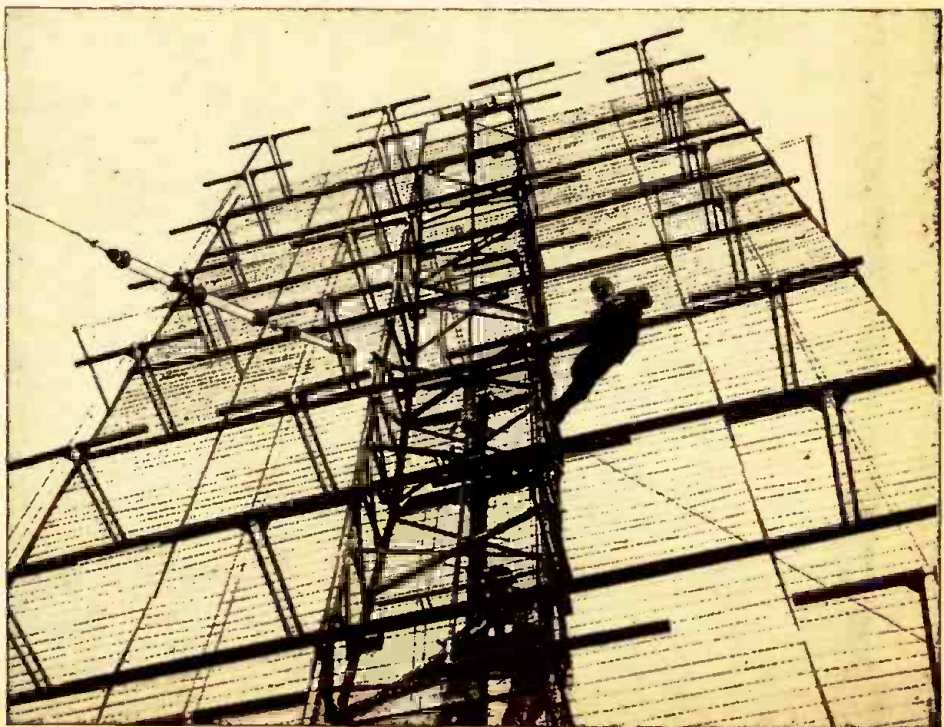

Photo A—Example of a complex FM array, the antenna of WOR's station in New York City.



# RADIO DATA SHEET 344

## NATIONAL UNION "PRESENTATION" RADIO MODEL G-619



**CIRCUIT:**  
A.c.-d.c. Superheterodyne — Tuned  
r.f. stage—a.v.c.

**TUNING:**  
Broadcast Band

**POWER SUPPLY:**  
—105-125 volts, 60 cycles a.c.—105-  
125 volts, direct current—Approx. 30  
watts consumption

**TUBE COMPLEMENT:**  
1 12SK7GT r.f. amp.  
1 12SA7GT Converter  
1 12SK7GT i.f. amp.  
1 12SQ7GT Det.-a.v.c.-a.f.  
1 35L6GT Power output  
1 35Z5GT Rectifier

### PRELIMINARY.

(a) Adjust the **DIAL POINTER** along the dial cord to the position opposite the first right-hand **punch mark** on the dial backing-plate, with the tuning condenser gang completely out of mesh (Minimum Capacity); (b) Set **VOLUME CONTROL** to the **FULL ON** position; (c) Main-  
tain **SIGNAL GENERATOR** output at **MINIMUM** consistent with a readable Output Meter  
indication; (d) **OUTPUT METER** across voice coil; (e) Follow sequence indicated below.

SEQUENCE	DUMMY ANTENNA	DIAL SETTING	SIGNAL GENERATOR CONNECTIONS	SIGNAL GENERATOR SETTING	ADJUST TRIMMERS	NOTES
1 I.F.	.01 mfd.	At HIGH frequency end of scale. (Min. Capacity)	High side to sta- tor lug of C2-A (Fig. 1). Low side to B—	455 K.C.	T2a T2b T1a T1b (Fig. 1)	Adjust Trimmers for MAX. output reading
2 OSC.	3 turn coil of #18 or #20 insulated wire on 7" or 8" diameter <b>LOOSELY</b> Coupled to loop Antenna in Re- ceiver	Pointer at ex- treme <b>RIGHT</b> <b>HAND END</b> of dial scale (Min. Capacity) Point- er will be in line with <b>FIRST</b> punch mark at right	Across Dummy Antenna	1700 K.C.	Tb (Fig. 1)	Adjust Trimmer for MAX. output reading
3 R.F.	Same as in 2 above	Pointer in line with punch mark <b>SECOND</b> from right	Same as in 2 above	1520 K.C.	Ta (Fig. 1)	Adjust Trimmer for MAX. output reading
4	Same as in 2 above	At <b>LOW</b> fre- quency end of scale (Max. Ca- pacity)	Same as in 2 above	530 K.C.	None	530 K.C. signal should be picked up or near this dial setting. Check operation in Seq. 2 if sig- nal is not picked up

### REINSTALLING CHASSIS (AFTER ALIGNMENT):—

- With chassis still on the bench, set dial pointer at the minimum capacity end of travel.
- Slide chassis into cabinet and adjust its position so that the dial pointer is opposite and in line with the **FIRST** calibration mark at the right-hand end of the **GLASS DIAL SCALE**.
- Tighten the chassis hold down screws.
- Tuning should now track so that peak signal is attained at the proper frequency calibration on the glass dial scale.

### ANTENNA:

Self-contained loop—Coupling for external antenna.

### CABINET:

Approximate Dimensions—  
Height—13 inches  
Width—8¾ inches  
Depth—6½ inches

### SERVICE NOTES

#### HUM MODULATION:

On Early Production runs Con-  
denser C-18 consisted of two —  
.05 µf units. One ground terminal  
was connected to CHASSIS, the  
other to B—. Disconnect the  
CHASSIS terminal of the .05 Con-  
denser now connected to Pin No.  
1 of the 12SA7GT tube and con-  
nect this lead to Pin No. 5 of  
either of the 12SK7GTs or to any  
other convenient B— point. This  
effectively by-passes the a.c. mod-  
ulation hum to B— instead of to  
chassis.

#### OSCILLATION:

Remove one side of Resistor R-2  
(in grid circuit of 12SA7GT) now  
connected to a.v.c. bus and recon-  
nected to cathode No. 5 pin) of i.f.  
—12SK7GT.

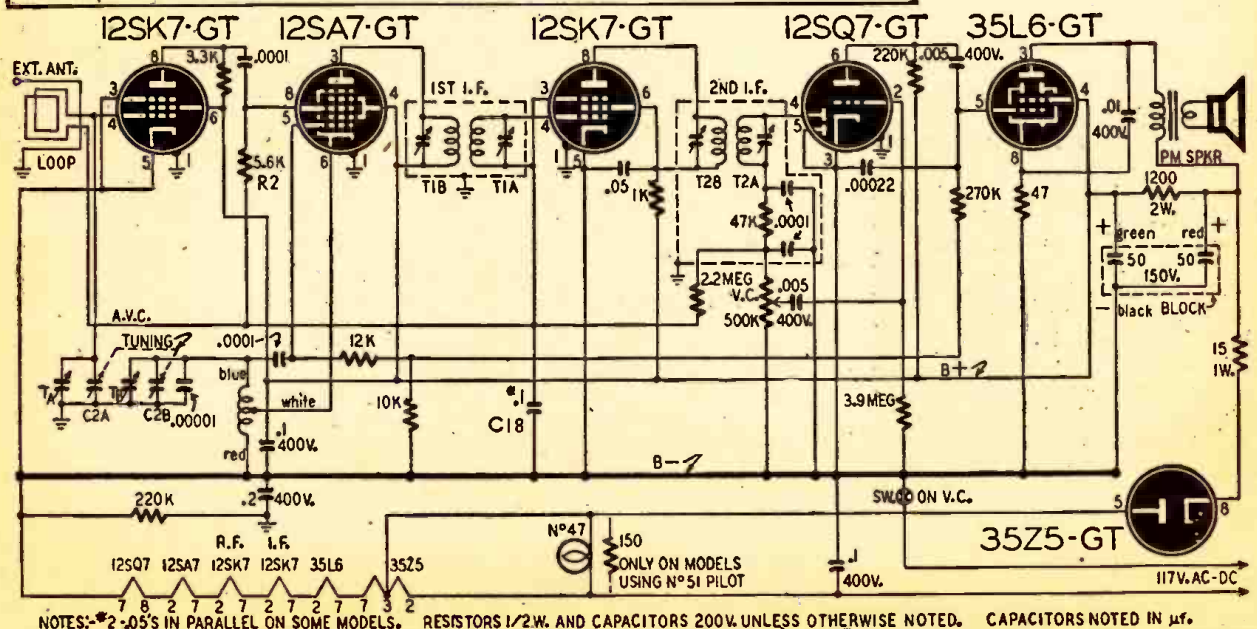

NOTES: \*2-.05'S IN PARALLEL ON SOME MODELS. RESISTORS 1/2W. AND CAPACITORS 200V. UNLESS OTHERWISE NOTED. CAPACITORS NOTED IN µf.



# TRANSATLANTIC NEWS

From our European Correspondent, Major Ralph Hallows



**T**HERE has been no small amount of disappointment that the post-war radios so far offered for sale here have failed to show the wonderful improvements which the ordinary man and woman had been led to expect. Having read a thousand times that spectacular advances in radio technique were made during the war, they can't detect any evidence of their application in the new radios in the shops. Most of these look (and sound) to them very much like the same old pre-war works in very much the same old boxes! And I am sorry to have to confess that the impressions formed by Mr. and Mrs. Broadcast Listener are too often not very far from the truth! We are woefully short of raw materials—insulated wire, stampings for transformer cores and metal for loud-speaker magnets in particular. This, combined with labor shortages, has led manufacturers to concentrate mainly on the small superhet receiver, containing four or five tubes in addition to the main rectifier.

Now there are not many changes that you can ring on such combinations of tubes. Nor can you introduce much in the way of frills when component manufacturers quote delays of anything from twelve to thirty-six months for the delivery of any but the most ordinary of

that the war began for us in 1939.)

Nevertheless, some firms have managed to produce real novelties—novelties of genuine value, and not mere flat-catching stunts. One of these is the Murphy A104 receiver, the design of which strikes out in an entirely new line. The basic idea? To get rid of the "boxiness" and "boominess" which are the almost inevitable results of making a smallish cabinet act as the baffle for the loud-speaker. Every reader of RADIO-CRAFT knows that if a flat baffle is used better reproduction is obtainable than with the loud-speaker cooped up in a cabinet. Much of the thudding base we know too well is due to cabinet resonances. The trouble is to know how to find a convenient place for a flat baffle.

In this Murphy set the problem is solved ingeniously by, so to speak, hanging the receiver on to a 24 by 18-inch baffle. The illustration shows how this is done. The receiver itself is long and narrow with almost a straight-line lay-out from antenna to output terminals. In use it should stand on a hard surface, which becomes an extension of the baffle.

This is something more than just an idea. It really works. The reproduction is so much better than that obtainable with box-type cabinets that readers may care to try out designs of their own on the same lines.

## Far-East Transmissions

Short-wave fans may have been puzzled over the location of a station broadcasting in English on 7.185 mc., and announcing itself as Radio SEAC. This is the British Army 100-kw transmitter in Ceylon, which sends out daily entertainment programmes from 1330 EST. These programmes are broadcast simultaneously by a 15-kw transmitter on 15.12 mc.

## Carrier-Current Broadcasting

In England a large and prosperous system of relaying broadcast programmes was in being before the war and it is now growing vigorously. To understand why it is popular you must realize that in all Britain there are only 16 broadcasting stations, all run by the BBC. These transmit between them two programmes, the regional and the national. In most places both programmes are receivable with good strength and quality. But there are places where reception is none too good; it may be that the field strength is insufficient, or it may be that man-made static spoils things.

Here is how relaying has been worked hitherto. A corporation, having obtained the necessary authorization, sets up a large receiving station at an interference-free spot and offers to any who

will sign on for a small weekly subscription a "piped" programme service, guaranteed free from fading and interference. The subscription is about 35 cents a week. In return the relay company runs wires to the subscriber's house, supplies him with a small amplifier and a loudspeaker and gives him a choice of two programmes at all times.

A week or two ago an entirely new type of relay system was inaugurated at Rugby. In this carrier-frequency methods are used and the subscriber has the choice of any one of six available programmes, though only one pair of wires runs to his house. The receiving equipment consists of a 3-tube unit, provided with a selector switch and a volume control. It is planned to extend the carrier-frequency system to other localities in the near future.

## Popularity Meter

Incidentally, the relay services supply an infallible method of determining not only whether a particular programme item is liked or not, but also just how much it is liked or disliked. The engineers at each main relay station have meters in the output circuits of their equipment and they can tell instantly, by glancing at the loads registered on their dials, what proportion of the subscribers are listening at any moment, for the load is naturally heavy when there are many and light when there are few. Some of the most interesting

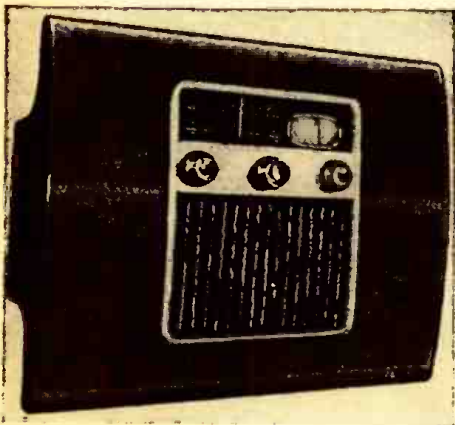

A front view of the baffle-mounted radio set.

small parts. Those are some of the chief reasons why the majority of our present-day radios differ so little from the receivers of seven years ago (remember

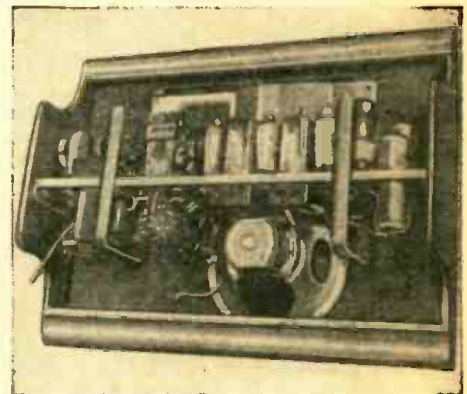

Side-pieces hold the baffle clear of the wall.

hours that I have ever spent were at such a relay station, watching the dials of the output load meters and observing their continuous record of listeners' reactions to the various programme items.

## Anti-fading Antenna

A novel type of anti-fading vertical radiator has just been brought into use by the BBC in connection with one of the 100-kw transmitters at Brookman's Park, near London. The 500-foot lattice mast is divided into two sections by means of three low-capacity insulators, each 3 feet high and 9 inches in diam-

(Continued on page 63)



# SOUND ENGINEERING — No. 27

This department is conducted for the benefit of all RADIO-CRAFT readers. All design, engineering, or theoretical questions of general interest on PA installation, sound equipment, and audio amplifier design will be answered in this section. No circuit diagrams can be supplied by mail, all answers being printed in order of their receipt.  
 (Note: when questions refer to circuit diagrams published in past issues of technical literature, the original, or a copy of the circuit should be supplied in order to facilitate reply.)

## RECORDING AMPLIFIER

### The Question:

I am desirous of building first-rate recording equipment. I have been searching for a suitable diagram for some time and have not been able to find one. I was wondering if you could furnish me one with the following specifications:

1. Crystal recording head to be used.
2. Playback (crystal pickup) to be included.
3. Usable as a small PA system.
4. Volume-level indicator of some kind, either meter or a cathode tube, incorporated.
5. High-fidelity—with inverse feedback.

Can you supply me with such a diagram? I will greatly appreciate any help you can give me.

JOHN G. SJOBLUM,  
Anderson, Indiana,

### The Answer:

A circuit diagram of the type you request is given in Fig. 1. You will note that a voltage doubler is used in the rectifier supply and a combination isolation and filament transformer is used to isolate the circuit from the 117-volt

a.c. power line. This circuit has been successfully used on a number of commercial recording amplifiers.

A specific circuit for the crystal recording head has not been given as manufacturers' recommendations should be followed for the particular recording head employed. Connections to crystal cutters are usually made directly from the plate circuit of the push-pull output stage, through condenser and resistor networks as recommended by the manufacturer. The high-voltage secondary in the isolation transformer is approximately 125 volts, rated at about 150 mils.

## ELECTRONIC TREMOLO

### The Question:

I have built several amplifiers for electric guitars and sold them, but I want to make an improvement on them.

About a year ago, I saw one that had a feature that I would like to add, but as yet I have had no success with it.

This amplifier had something in it that, when you threw a switch, gave a solid note a quivering or tremolo effect somewhat similar to a vibrating pulsation of a Hawaiian guitar.

My amplifier is of the conventional design consisting of a 57, 56, and two 2A3's in push-pull. I would appreciate it very much if you could give me some idea on how to construct this unit.—  
WALTER G. BRADY, Turtle Creek, Pa.

### The Answer:

A vibrating pulsation produced on a Hawaiian guitar actually is a variable-pitch tremolo which is produced either on the flat or sharp side, depending upon the direction the player vibrates his finger. This type of effect cannot be easily produced electronically in an ordinary amplifier which has a fixed-frequency signal fed into it. It can be incorporated, however, into a synthetic musical generator by slightly altering the frequency of the master oscillator tube.

The volume-changing tremolo (or vibrato) is considered colorless and monotonous by many musicians. This effect, however, can more easily be produced in an amplifier by simply arranging for a rapid and fluctuating change in the gain of an amplifier tube. A rough idea of how this can be added to any amplifier, follows:

Set up a controlled sine-wave low-frequency oscillator (which will determine the rate of the vibrato). The output of the oscillator is then fed into one of the grids in a variable-mu tube so that a vibrating change of gain in the vibrator tube will produce a vibrating change of level at the output of an amplifier. Fig. 2 is the circuit of an electronic volume-changing tremolo which was set up in our laboratory and found to operate exceptionally well.

You will note that the 6SK7 is used as a tremolo variable-mu tube. The oscillator was made variable from 3 to 12 cycles (in our experiments) to control the speed of vibrato. If you prefer, this may be a fixed oscillator.

The amplitude of the vibrato is dependent on the voltage of the oscillator. We found a voltage range from 10 to 55 volts more than adequate.

If you are interested in additional details on the production of tremolo and vibrato effects in synthetic electronic musical instruments, get I. E. Remeeff's (Continued on page 59)

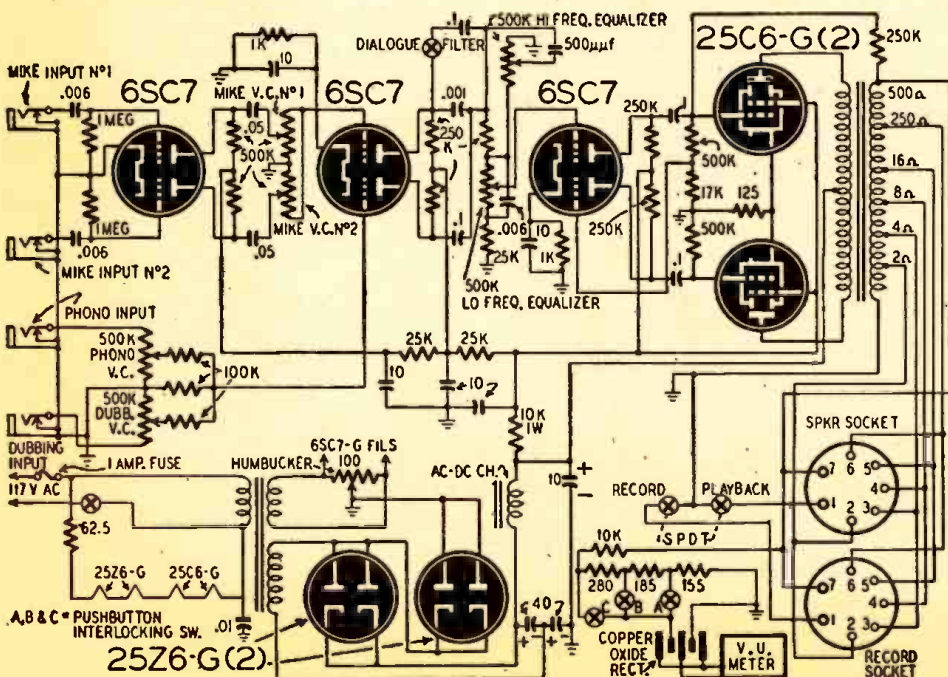
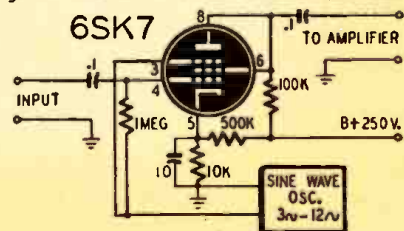

Fig. 1—An amplifier designed for recording.  
Fig. 2—Tremolo unit for musical instrument.





# WORLD-WIDE STATION LIST

**W**E inaugurate in this issue what we believe is a new idea in listing station schedules. The time will henceforth be stated in four figures of a twenty-four hour clock in Eastern Standard Time. Thus midnight will be stated either as 0000 (if a program begins at midnight) or 2400 (if the program ends at midnight); what was formerly 1 am will now be 0100 and 2:15 am will be 0215. Noon will be expressed as 1200 and 6 pm will be given as 1800. Please remember that these times are EST. We think that you will also like this new system when you have used it a few months, as it will eliminate the possibilities of mistaking am for pm and vice versa. It will be greatly appreciated if you will give your times this way when sending in reports to us.

The picture of Eddie Startz, six-language announcer of "The Happy Station" was sent us by North American Philips. We would like more photos of shortwave announcers and stations.

You will note several changes since the last time we published this section of the log, as many stations have changed their frequencies and schedules. The CBC announced the following basic schedule for the balance of the winter; CKNC on 17.82 megacycles



Eddie Startz, of Huizen, Netherland key station, world-famous international announcer.

from 0930 to 1245; CKCX on 15.19 megacycles from 0930 to 1200; CKCS on 15.32 megacycles from 1205 to 1500; CHOL on 11.72 megacycles from 1300 to 1800; and CKLO on 9.63 megacycles from 1515 to 1800. These are all beamed to Europe; while the following are directed to the Caribbean area: CKRA on 11.76 megacycles from 1820 to 1935 and CKRZ on 6.06 megacycles from 1820 to 1935.

XGOY is being heard on 6.154 megacycles from 0630 to 0745 hours EST, with very good results. This is a good catch for early morning. The Chinese have discontinued use of 9.635 megacycles for the balance of the winter months. A new Ethiopian is now being heard from Addis Ababa on 15.065 megacycles from 1330 to 1500 and from 2015 to 2130. Has not been heard here yet, nor have we any reports of it being heard, but we are looking for it. Have you heard it?

New certificates will be out about the time you are reading this, so if you wish an appointment for the coming year let us hear from you. Regular observers will automatically be re-appointed, but we could use reports from several more. Send all inquiries to Shortwave Editor, c/o RADIO-CRAFT, 25 West Broadway, New York City 7.

Freq.	Station	Location and Schedule	Freq.	Station	Location and Schedule	Freq.	Station	Location and Schedule
2.500	WVW	WASHINGTON, D. C.; U. S. Bureau of Standard, 1900 to 0900.	4.880	HJFH	ARMENIA, COLOMBIA: 0600 to 2200	6.020	XEUW	VERA CRUZ, MEXICO: 0700 to 0100.
3.310	YV1RO	TRUJILLO, VENEZUELA: 1700 to 2130.	4.890	HJCH	BOGOTA, COLOMBIA: 1800 to 2200.	6.020	FZ1	BRAZZAVILLE, FRENCH EQUATORIAL AFRICA: 1600 to 1845; 0000 to 0130.
8.340	VUD3	DELHI, INDIA: 1200 to 1245.	4.920	CR7BO	LOURENCO MARQUES, MOZAMBIQUE: 1330 to 1500; Sundays, 1000 to 1400.	6.020	PCJ	HUIZEN, NETHERLANDS: 1400 to 1430; 1745 to 1815; 2000 to 2200.
3.370	YV1RT	MARACAIBO, VENEZUELA: 1730 to 2230.	4.920	YV5RN	CARACAS, VENEZUELA: 0600 to 2230.	6.030	CFYP	MOSCOW, U.S.S.R.: schedule unknown.
3.380	YV5RY	CARACAS, VENEZUELA: 0930 to 2230.	4.920	HJAP	CARTAGENA, COLOMBIA: 0600 to 1300; 1700 to 2200.	6.030	HP5B	CALGARY, CANADA: 0730 to 0100.
3.390	YV4RK	MARACAY, VENEZUELA: 1800 to 2230.	4.940	HJCV	BOGOTA, COLOMBIA: 0645 to 1115; 1600 to 2315.	6.040	GRR	PANAMA CITY, PANAMA: 1800 to 2300.
3.390	YV5RW	COLOMBO, CEYLON: 0600 to 1200.	4.950	VQ7LO	NAIROBI, KENYA: 1100 to 1400.	6.040	CFRX	ALGIERS, ALGERIA: 1230 to 1800.
3.400	YV5RZ	CARACAS, VENEZUELA: 0530 to 2230.	4.950	HJCC	BOGOTA, COLOMBIA: 1000 to 1400; 1700 to 2300.	6.070	CFRX	RANGOON, BURMA: 0630 to 0230; 0615 to 0830; 2100 to 2145.
3.420	YV2RC	MERIDA, VENEZUELA: 1800 to 2130.	4.960	HJAE	CARTAGENA, COLOMBIA: 1600 to 2230.	6.040	COBF	HAVANA, CUBA: 0800 to 2300.
3.440	YV1RU	MARACAIBO, VENEZUELA: 1900 to 2130.	4.990	YV3RN	BARQUISIMETO, VENEZUELA: 1630 to 2130.	6.040	XETW	TAMPICO, MEXICO: 0745 to 0045.
3.460	YV4RP	VALENCIA, VENEZUELA: 1730 to 2130.	5.000	WVW	WASHINGTON, D. C.; U. S. Bureau of Standards; frequency, time and musical pitch; continuously day and night.	6.060	GRR	TETUAN, SPANISH MOROCCO: 0230 to 0300; 1330 to 1830.
3.480	YV4RQ	PUERTA CABALLO, VENEZUELA: 1700 to 2130.	5.300	DTYC	MUNICH, GERMANY: 0900 to 0930.	6.070	CFRX	LONDON, ENGLAND: 2300 to 0030.
3.490	YV3RS	BARQUISIMETO, VENEZUELA: 1630 to 2230.	5.530	OAX1B	PUIRA, PERU: 1800 to 2330.	6.070	CFRX	TORONTO, CANADA: 0600 to 2345.
3.500	YV5RX	CARACAS, VENEZUELA: 0930 to 1400; 1530 to 2230.	5.810	HH2S	MOSCOW, U.S.S.R.: schedule unknown.	6.070	CFRX	BERLIN, GERMANY: 0000 to 0345.
3.510	YV6RC	BARQUISIMETO, VENEZUELA: 1800 to 2130.	5.840	PZH5	PARAMARIBO, SURINAM: 1800 to 2045.	6.070	CFRX	COLOMBO, CEYLON: 1930 to 0545; 0715 to 1200.
3.530	YV5RS	CARACAS, VENEZUELA: 0530 to 2230.	5.870	HRN	TAGUCIGALPA, HONDURAS: 0800 to 1000; 1300 to 1500; 1800 to 2300.	6.080	WLWK	CINCINNATI, OHIO: 1830 to 0100.
3.910	ZQP	LUSAKA, SOUTHERN RHODESIA: 2230 to 1800.	5.880	ZRK	CAPETOWN, SOUTH AFRICA: 2345 to 0130; 1030 to 1600.	6.080	CKFX	VANCOUVER, CANADA: 0930 to 0300.
3.930	HC5EH	CIUDAD CUENCA, ECUADOR: 1800 to 2230.	5.890	OAX4Z	MOSCOW, U.S.S.R.: 0800 to 1645.	6.090	LRY1	BUENOS AIRES, ARGENTINA: 0545 to 0715; 1800 to 2100.
4.040	HC1B	PONTA DEL GADA, AZORES: 1700 to 1900.	5.890	OZX4V	LIMA, PERU: 1630 to 2330.	6.090	CBFW	LUXEMBOURG: 1430 to 1700.
4.100	HC1B	QUITO, ECUADOR: 1800 to 2230.	5.910	HH2S	LIMA, PERU: 1800 to 2400.	6.090	CBFW	MONTREAL, CANADA: 0730 to 1845; 2000 to 2400.
4.750	YV1RV	MARACAIBO, VENEZUELA: 0530 to 2130.	5.950	HH2S	PORT-AU-PRINCE, HAITI: 0600 to 0815; 1100 to 1300; 1730 to 2130.	6.090	ZYB7	SAO PAULO, BRAZIL: 1600 to 1950.
4.770	YV1RY	CORO, VENEZUELA: 1600 to 2130.	5.960	RV19	MOSCOW, U.S.S.R.: 1700 to 2000.	6.100	VUD10	DELHI, INDIA: 0830 to 0915; 2030 to 2200.
4.780	YV4RO	SINGAPORE, MALAYA: 1730 to 2230; 2330 to 0130.	5.970	HVJ	VATICAN CITY: 0900 to 0930; 1000 to 1100; 1300 to 1330.	6.100	PRE9	WARSAW, POLAND: 1330 to 2100.
4.780	HJAB	VALENCIA, VENEZUELA: 1630 to 2130.	5.980	LRS1	ST. JOHNS, NEWFOUNDLAND: 0900 to 1400; 1500 to 2200.	6.110	GSL	FORTALEZA, BRAZIL: 1530 to 2100.
4.780	HJAB	BARRANQUILLA, COLOMBIA: 1700 to 2255.	5.990	FG8AH	BUENOS AIRES, ARGENTINA: 1800 to 2300.	6.120	HP5H	LONDON, ENGLAND: 1500 to 1745; 1900 to 0030.
4.790	BANDENG	BANDENG, NETHERLAND INDIES: 0750 to 0800.	6.000	ZFY	ANDORRA: 0500 to 1800.	6.130	XEUZ	PANAMA CITY, PANAMA: 0700 to 2300.
4.810	YV1RL	MARACAIBO, VENEZUELA: 0530 to 2230.	6.000	CFCX	POINTE-A-PITRE, GUADELOUPE: 1700 to 1800.	6.130	CHNX	MEXICO CITY, MEXICO: 1500 to 0030.
4.810	HJBB	CUCUTA, COLOMBIA: 1700 to 2200.	6.000	HP5K	GEORGETOWN, BRITISH GUIANA: 0545 to 0745; 0915 to 1145; 1415 to 1845.	6.130	COCD	HALIFAX, NOVA SCOTIA: 0700 to 2300.
4.820	XE1G	GUADALAJARA, MEXICO: 2200 to 2400.	6.010	ZRH	MONTREAL, CANADA: 0700 to 2315.	6.140	HJDE	HAVANA, CUBA: 0700 to 2400.
4.820	HJED	CALI, COLOMBIA: 1900 to 2300.	6.010	CJCX	COLON, PANAMA: 0700 to 1300; 1800 to 2300.	6.150	GRW	MEDELLIN, COLOMBIA: 1100 to 2300.
4.830	YV2RN	SAN CHRISTOBAL, VENEZUELA: 1100 to 2130.	6.020	HJCX	JOHANNESBURG, SOUTH AFRICA: 2345 to 0130; 0900 to 1100.	6.150	CKRO	LONDON, ENGLAND: 1445 to 1500; 1800 to 2215; 2330 to 2345.
4.860	PRC5	BELEM, BRAZIL: 0600 to 1100; 1630 to 2000.			SYDNEY, NDVA SCOTIA: 0580 to 2200.	6.150	EQB	WINNIPEG, CANADA: 2200 to 0300.
						6.150	TIRH	BELGRADE, YUGOSLAVIA: 1130 to 1800.
						6.150	CSWD	TEHERAN, IRAN: 1000 to 1415; 2230 to 2400.
						6.160	HJCD	SAN JOSE, COSTA RICA: 2130 to 2400.
								LISBON, PORTUGAL: 1430 to 1900.
								BOGOTA, COLOMBIA: 0700 to 0800.

(Continued on page 64)



# RADIO-ELECTRONIC CIRCUITS

## NOVEL RECEIVER

This is a sensitive superregenerative receiver. It uses the new 6AK5 high-frequency pentode and standard plug-in coils. The a.f. amplifier is a 6K6. A small power supply using a 6X5 supplies 200 volts for the plates of the tubes. If the voltage on the plate of the 6AK5 exceeds 180 volts, a resistor should be inserted between the B-plus lead and the 500-henry choke to drop the voltage to the desired value (See Fig. 1).

The power supply should be turned off when changing coils to avoid the risk of receiving a shock and to prevent operating the detector without plate voltage.

JOHN JUSTIN,  
Cicero, Ill.

## PHONO AMPLIFIER

Here is a phono amplifier that has given good service for over a year. It uses push-pull throughout and has a very low hum level. Inverse feed-back tends to flatten the response curve. An Astatic HP 16 pickup, with an output of 0.85 volt, is used to drive the voltage amplifier stage. A 12-inch PM speaker, housed in a bass-reflex cabinet, is used with the amplifier (See Fig. 2).

FLOYD R. HARRIS,  
Denver, Colo.

## UNIVERSAL ANTENNA

This circuit contains practically all of the condensers and resistors that may be specified by set manufacturers, as dummy antennas for aligning their receivers. The components are mounted in a 2 x 6 x 1 1/2-inch metal box which provides sturdy connections and adequate shielding against radiation.

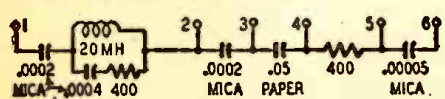

In use, the signal generator is connected to one side of the desired component and the receiver antenna post to the other. If the manufacturer of the set does not specify the type of dummy antenna to be used, the I.R.E. universal

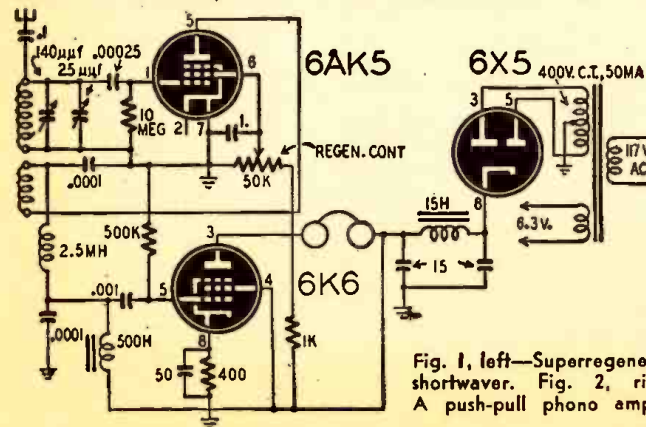

Fig. 1, left—Superregenerative shortwave. Fig. 2, right—A push-pull phono amplifier.

antenna may be used by connecting the signal generator to pin No. 1 and the set antenna to pin No. 2.

RALPH J. WALSH,  
Altadena, Calif.

## tone CONTROL

I constructed an amplifier using a tone-control circuit similar to that shown in Fig. 2, page 763, of the August issue, and found that there was interaction between the controls and motorboating when the bass control was

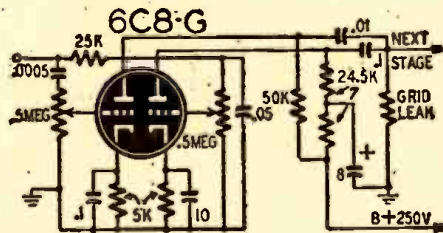

advanced beyond the mid-point. By changing the circuit to that shown here, I have improved the bass response and stopped interaction and motorboating.

JOHN KWIENTINSKAS,  
Duquesne, Penna.

## DUPLEX DETECTOR

Here is a circuit that I use on my receiver to permit me to use either a diode or infinite-impedance detector at will.

A s.p.d.t. switch connects the plate of the detector to B-plus or to the cathode, depending on the circuit in use. As a diode detector, the 20,000- and 100,000-ohm resistors form the load resistor with the audio output taken off at the junction of the resistors. As triode infinite-impedance detector, a.f. voltage is taken off of the cathode load resistors. Signal voltage is taken from the plate of the i.f. or r.f. amplifier and rectified by a 1N34 crystal diode. This rectified voltage is applied in series with 1 to 3 volts of fixed bias which provides delayed

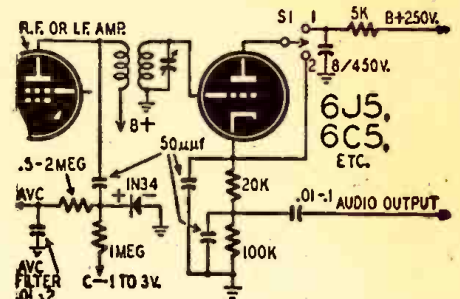

a.v.c. The bias voltage may be obtained from batteries, bias cells or a tap on the bleeder resistor.

H. M. HARVEY,  
Scotch Plains, N. J.

## COMPACT INTERCOM

Here is a circuit of a compact instant-heating intercommunicator. A 1N5-G drives a 3Q5-GT power amplifier.

Small PM speakers are used at the master and remote stations where they serve either as speakers or microphones. Talk-listening switching is done with a d.p.d.t. lever switch.

The power supply uses a Federal selenium rectifier to supply high voltage for the plates and screen grids and 4.5 volts for the series-connected filaments.

The speaker voice coils are matched to the 1N5-G grid with a voice-coil-to-grid transformer designed for use in intercom units. An 8,000-ohm output transformer matches the plate of the 3Q5-GT to the voice coils. If it is not necessary for the remote station to initiate a call, the unit may be turned off until the master makes a call.

F. C. HOFFMAN, W9VVU,  
Appleton, Wis.

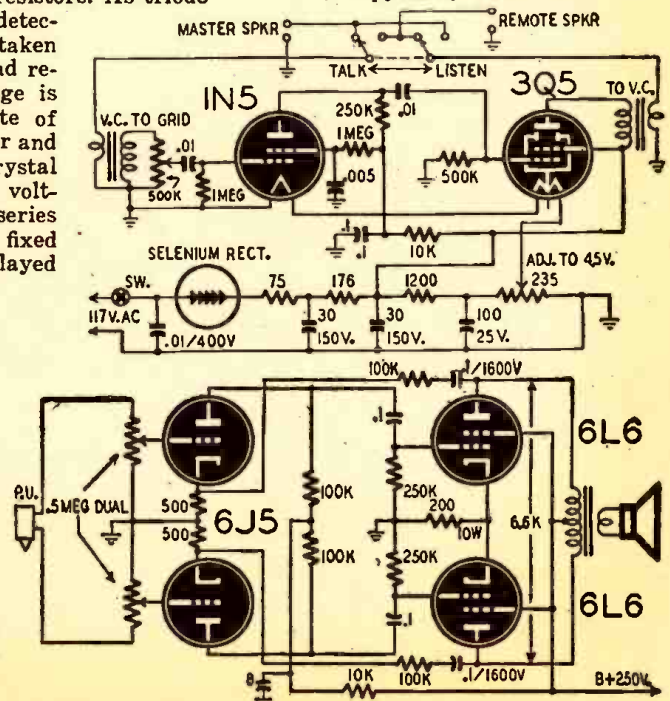



# SUPERIOR IS AT YOUR SERVICE

with a COMPLETE LINE of TEST INSTRUMENTS



## IMMEDIATE SHIPMENT

Please place your order with your regular radio parts jobber. If your jobber does not handle our line, kindly write for a list of jobbers in your state who do distribute our instruments, or send your order to us.

### Now you can SEE and HEAR The Signal with the new CA-12 SIGNAL TRACER

Always ready for instant use it takes less than five seconds to begin using this versatile unit. No maze of special cables—the Model CA-12 uses only one connecting cable. No line cord—the CA-12 operates on self-contained batteries. No tuning controls of any kind are used in this model.

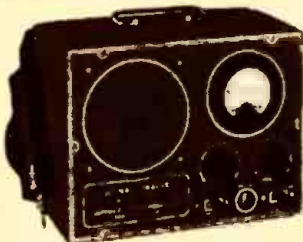

#### Features:

- \* COMPARATIVE INTENSITY of the signal is read directly on the meter—QUALITY of the signal is heard in the speaker.
- \* Simple to operate—only one connecting cable—no tuning controls.
- \* Highly sensitive—uses an improved vacuum-tube voltmeter circuit.
- \* Tube and resistor capacity network are built into the detector probe.
- \* Built-in high gain amplifier—Alnico V. speaker.
- \* Completely portable—weight 8 pounds—measures 5½" x 6½" x 9".

THE MODEL CA-12 comes complete with Detector Probe, test leads, self-contained batteries and instructions. Comes housed in heavy gauge crystalline cabinet with beautiful two tone etched front panel. NET PRICE **\$34<sup>85</sup>**



### The New Model 450 TUBE TESTER

Speedy operation—assured by newly designed rotary selector switch which replaces the usual snap, toggle, or lever action switches.

#### SPECIFICATIONS:

- \* Tests all tubes up to 117 volts.
- \* Tests shorts and leakages up to 3 Megohms in all tubes.
- \* Tests both plates in rectifiers.
- \* New type line voltage adjuster.
- \* Tests individual sections such as diodes, triodes, pentodes, etc., in multi-purpose tubes.
- \* Noise-Test—detects microphonic tubes or noise due to faulty elements and loose internal connections.
- \* Uses a 4½" square rugged meter.
- \* Works on 90 to 125 volts 60 cycles A.C.
- \* EXTRA SERVICE—May be used as an extremely sensitive condenser Leakage Checker. A relaxation type oscillator incorporated in this model will detect leakages even when the frequency is one per minute.

**\$39<sup>50</sup>**



### The New Model 670 SUPER METER

A Combination VOLT - OHM MILLIAMMETER plus CAPACITY REACTANCE, INDUCTANCE and DECIBEL MEASUREMENTS

#### SPECIFICATIONS

D.C. VOLTS: 0 to 7.5/15/75/150/750/1,500/7,500 Volts  
A.C. VOLTS: 0 to 15/30/150/300/1,500/3,000 Volts  
OUTPUT VOLTS: 0 to 15/30/150/300/1,500/3,000 Volts  
D.C. CURRENT: 0 to 1.5/15/150 Ma. 0 to 1.5 Amperes  
RESISTANCE: 0 to 500/100,000 Ohms 0 to 10 Megohms

CAPACITY: .001 to .2 Mfd. 1 to 4 Mfd. (Quality test for electrolytics)  
REACTANCE: 700 to 27,000 Ohms 13,000 Ohms to 3 Megohms  
INDUCTANCE: 1.75 to 70 Henries 35 to 8,000 Henries  
DECIBELS: -10 to +18, +10 to +38, +30 to +58  
The Model 670 comes housed in a rugged, crackle-finished steel cabinet complete with test leads and operating instructions. NET **\$28<sup>40</sup>**  
Size 5½" x 7½" x 3"



### The New Model 600 SET TESTER

A NEW COMBINATION TUBE TESTER AND MULTI-METER

A complete testing laboratory all in one unit. Test tubes. Reads A.C. Volts, D.C. Volts, D.C. Currents, Resistances and Decibels.

#### TUBE TESTER SPECIFICATIONS:

- \* Speedy operation—assured by newly designed rotary selector switch.
- \* Tests all tubes up to 117 Volts.
- \* Tests shorts and leakages up to 3 Megohms in all tubes.
- \* Tests leakages and shorts of any one element against all elements in all tubes.
- \* Tests both plates in rectifiers.
- \* Tests individual sections such as diodes, triodes, pentodes, etc., in multi-purpose tubes.
- \* New type line voltage adjuster.

#### MULTI-METER SPECIFICATIONS:

D.C. VOLTS: (At 1,000 Ohms Per Volt) 0 to 7.5/15/75/150/750/1,500 Volts.  
A.C. VOLTS: 0 to 15/30/150/300/1,500/3,000 Volts.  
D.C. CURRENT: 0 to 1.5/15/150 Ma. 0 to 1.5 Amperes.  
RESISTANCE: 0 to 2,000/20,000/200,000 Ohms 0 to 20 Megohms.  
DECIBELS: (Based on zero decibels equals .006 Watts into a 500-Ohm line.) -10 to +18 D.B., +10 to +38 D.B., +30 to +58 D.B.



**\$62<sup>50</sup>**

### The New Model 650 SIGNAL GENERATOR

#### RANGES:

100 Kilocycles to 35 Megacycles on Fundamentals.  
25 Megacycles to 105 Megacycles on Harmonics.

- \* RF obtainable separately or modulated by the Audio Frequency.
- \* Audio Modulating Frequency—400 cycles pure sine wave—less than 2% distortion.
- \* Attenuation—3-step ladder type of attenuator (T pad).
- \* Uses a Hartley Excited Oscillator with a Buffer Amplifier.
- \* Tubes: 6J5 as R.F. Oscillator; 6SA7 as modulated Buffer and Mixer; 6SL7 as audio oscillator and rectifier. Complete with coaxial cable, leads and instructions.

**\$48<sup>75</sup>**



### The New Model 400 ELECTRONIC MULTI-METER

A COMBINATION VACUUM-TUBE VOLTMETER AND VOLT-OHM MILLIAMMETER PLUS CAPACITY, INDUCTANCE, REACTANCE AND DECIBEL MEASUREMENTS

#### Specifications:

D.C. V.T.V.M. VOLTS: (At 11 Megohms Input Resistance) 0 to 3/15/30/75/150/300/750/1,500/3,000 Volts.  
D.C. VOLTS: (At 1,000 Ohms Per Volt) 0 to 3/15/30/75/150/300/750/1,500/3,000 Volts.  
A.C. VOLTS: (At 1,000 Ohms Per Volt) 0 to 3/15/30/75/150/300/750/1,500/3,000 Volts.  
D.C. CURRENT: 0 to 3/15/30/75/150/300/750 Ma. 0 to 3/15 Amperes.  
RESISTANCE: 0 to 1,000/10,000/100,000 Ohms: 0 to 1/10/1,000 Megohms.  
CAPACITY: (In MFD) .0005—2, .05—20, .5—200.  
REACTANCE: 10 to 5M (Ohms, 100—60M (Ohms), .01—5 (Megohms).  
INDUCTANCE: (In Henries) .025—14, .35—140, 35—14,000.  
DECIBELS: -10 to +18, +10 to +, +30 to +58.

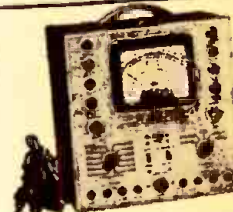

**\$52<sup>50</sup>**



# SUPERIOR INSTRUMENTS CO.

Dept. RC 227 FULTON ST., NEW YORK 7, N. Y.



BUY FROM **RESCO** AND SAVE

**WIRE**

- #W22SL  
22 gauge stranded rubber-covered lead-in wire  
54¢ hundred ft.  
\$5 thousand ft.
  - #W2CM  
2 conductor shielded rubber-covered mike cable  
8¢ per ft.  
\$7.50 hundred ft.  
\$70 thousand ft.
  - #W20SH  
20 gauge stranded rubber-covered lacquer braid overall hook-up wire available in yellow, green, brown  
60¢ hundred ft.  
\$5 thousand ft.
  - #W22P  
22 gauge plastic-covered wire  
50¢ hundred ft.  
\$4.50 thousand ft.
  - #W22RL  
22 gauge solid rubber-covered lead-in wire  
45¢ hundred ft.  
\$4 thousand ft.
  - #W185M  
18 gauge stranded plastic-covered, cloth covered overall hook-up wire—available in orange, red, green, blue, yellow or grey  
60¢ hundred ft.  
\$5 thousand ft.
  - #W25J  
2 conductor SJ cord  
5¢ per ft.  
\$4.50 hundred ft.  
\$40 thousand ft.
  - #W18RB  
18 gauge stranded rubber-covered rayon braid  
60¢ hundred ft.  
\$5 thousand ft.
  - #W4C  
4 conductor, each conductor rubber-covered overall  
9¢ per ft.  
\$8.50 hundred ft.  
\$80 thousand ft.
  - 100 ft. coil 7/26 tinned antenna wire  
22¢ each  
10 for \$2
- Tinned braiding wire — all sizes in stock

**VOLUME CONTROLS**  
ASSORTED SIZE SHAFTS & VALUES  
(3/8"–2 3/4"), 15c–10 for \$1.35

- Octal wafers with metal flange \$ .04 10 for \$ .35
- Acorn Porcelain Sockets .45 10 for 4.25
- 6 ft. A. C. cord and bakelite plug .19 10 for 1.75
- 11 ft. A. C. cord with molded plastic plug & finger grip .35 10 for 3.25
- 6 ft. extension cord with dual table outlet .45 10 for 4.25
- 8 ft. extension cord with cube-top .49 10 for 4.75

**CONDENSER SPECIALS**

- MICA CONDENSERS, high voltages  
Assortment of 10 for \$1.00
- 8 mfd 475 WVDC 4 prong plug-in can condenser \$ .45 10 for 4.25
- .25 mfd 600 VDC metal tubular .10 10 for .90
- .01 mfd 400 VDC metal tubular .10 10 for .90
- .02 mfd 600 VDC metal tubular .10 10 for .90
- .005 mfd 600 VDC metal tubular .05 10 for .45
- 8 mfd 500 WVDC F. P. type .69 10 for 6.50
- 16 mfd 500 WVDC F. P. type .89 10 for 8.50
- 10-10 mfd 200 VDC—inverted can .39 10 for 3.75
- 25 mfd 300 VDC—inverted can .39 10 for 3.75
- 30 mfd 450 VDC—inverted can 1.15 10 for 11.00

SPECIAL BULLETIN OF VALUES ON RADIO PARTS AND EQUIPMENT

Send for Yours Today!

**Radio Electric**  
SERVICE CO. OF PENNA., INC.

7TH AND ARCH STREETS, PHILA. 6, PENNA.  
Branches: 5133 Market St. and 3145 N. Broad St. in Phila.  
Also in Wilmington, Del., Easton, Pa., Allentown, Pa., Camden, N. J.

**TRY THIS ONE**

**ANTENNA STATIC**

A continuous roar and crackle of static in an automobile radio may often be traced to a missing discharge knob from the top of a whip-type antenna. Although these knobs often appear in gay colors, they are not put on the antenna for a decorative effect. The round plastic knob is useful in reducing or eliminating corona or static electricity discharges from the body of the car.

Small bakelite screw-on battery terminals may be filed to a globular shape and soldered to the tip of the antenna. Do not use hard rubber knobs as they will melt during the soldering.

JACK SAMUELS,  
Olympia, Wash.

RADIO-CRAFT wants original kinks from its readers, and will award a one year subscription for each one published. To be accepted, ideas must be new and useful. Send your pet short-cut or new idea to RADIO-CRAFT today!

**DATA FILE**

Many valuable charts, reference tables and graphs are printed in the various radio magazines and books that the serviceman accumulates during his career. Much of this material is mislaid and forgotten unless there is some form of index to tell just where to find it when needed.

Such a convenient index may be compiled by using 3 x 5-inch cards and cataloging all tables and reference data. Use a different heading for each card, for example, Abbreviations, Ballast Resistors, Condenser Codes, etc. On the appropriate cards, list the material by title of chart, book and page number.

YVON JOHNSON,  
San Francisco, Calif.

**VOLUME CONTROL REPAIRS**

When the shaft of a volume control is clamped in a vise for cutting or milling, the slightest pressure to either side will cause the shaft to move and wobble between the jaws of the vise. To prevent this annoying condition, try placing another piece of control shaft in the opposite side of the vise. When the jaws are clamped tightly, the shaft may be cut or milled without any trouble.

GERALD EVANS,  
Ola, Ark.

**DIAL CORDS**

The dial drive drum on many radios is made of thin sheet metal that has a tendency to cut the dial cord at the point where it enters the drum. To remedy this condition and lengthen the life of the cord, enlarge the hole with a drill or reamer and insert a piece of spaghetti tubing into the hole.

WILLIAM A. HOME,  
Petitodice, N. B., Canada

**SPEAKER MATCHING**

I have my home radio wired so that it may be used with a remote loudspeaker.

The receiver was equipped with an 8-ohm speaker. I replaced the output transformer with a multimatch transformer and purchased another 8-ohm speaker for the remote position.

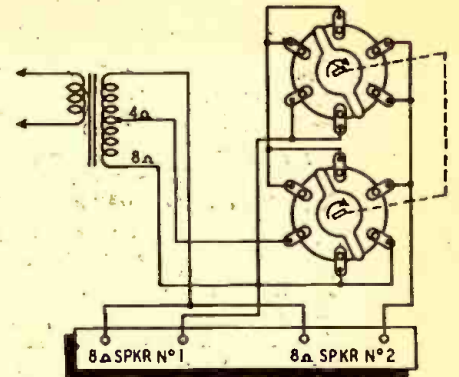

A two-gang circuit-selector switch is wired so that either speaker may be used alone by connecting it across the 8-ohm winding of the transformer. When the switch is in the third position, the speakers are paralleled across the 4-ohm top.

This arrangement may be used for any speaker impedances as long as the speaker impedances are matched when used alone or when paralleled.

SCT. A. W. ADEY,  
North Bay, Ontario

**ALIGNING RECEIVERS**

On a large number of radios, the frequency calibration is marked on a dial that is permanently fastened to the cabinet. This makes it impossible to ascertain the dial setting after the chassis has been removed.

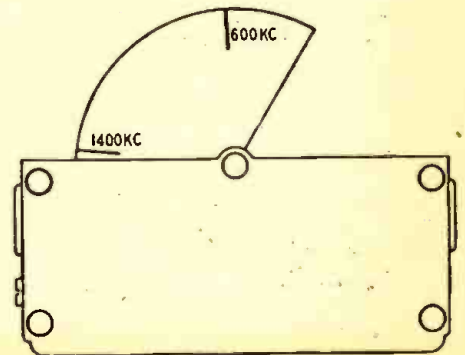

A simple and accurate way to overcome this difficulty is to mark the condenser rotor plates with a grease pencil at the alignment frequencies before removing the chassis.

OTTO WOOLLEY,  
Colorado Springs, Colo.



# WHAT SERVICEMAN COULDN'T MAKE MORE MONEY THIS WAY?

The business-like way to make money is to keep plugging ahead at your bench. If your stock is lean and you have to run to the distributor every time you need a volume control, you're frittering away your valuable "bench time" and income. Stock up too high on "special" volume controls and you may wind up behind an inventory 8-ball.

## HERE'S THE RIGHT ANSWER 9 OUT OF 10 TIMES

The sensible solution to your volume control replacements is the IRC *Century Line*. Over 90% (by actual analysis) of all jobs can be taken care of by these 112 types of volume controls. As a matter of fact, you don't even need the entire 112; a selection of only 70 Type D IRC Volume Controls and 11 Tap-In Shafts may handle most of your work. So see your IRC Distributor right away and save your bench time, patience, and money with IRC.

### THE IRC CENTURY LINE

The 112 Volume Controls and 5 Switches That Solve Over 90% of Your Replacement Problems.

- |  |  |
|--|--|
| 70 Universal Type D Controls with 11 easily installed Tap-in Shafts. | 7 Dual Controls with Fixed Shafts                            |
| 16 Popular Type Controls with Fixed Shafts                           | 9 Controls for Specific Service Uses with Fixed Shafts       |
| 8 Clutch Type Controls with Fixed Shafts                             | 2 Special Controls for Power Requirements with Tap-in Shafts |
|  | 5 Switches   |

All IRC Volume Controls have the famous IRC permanently bonded Resistance Element, the Five-Finger "Knee Action" Contactor, the Silent Spiral Spring Contactor, and the Steel Coil Spring Thrust Washer.



Bring yourself up to date with the new No. 4 Edition of this amazingly popular and useful manual. Contains detailed replacement information on nearly all models up to 1946. Complete listing of 1941-42 models... the ones now coming in for repair. 156 pages. 25c at your IRC Distributor.

## INTERNATIONAL RESISTANCE COMPANY

Wherever the Circuit says 

401 N. BROAD ST., PHILADELPHIA 8, PA.

In Canada: International Resistance Co., Ltd., Toronto, Licensee

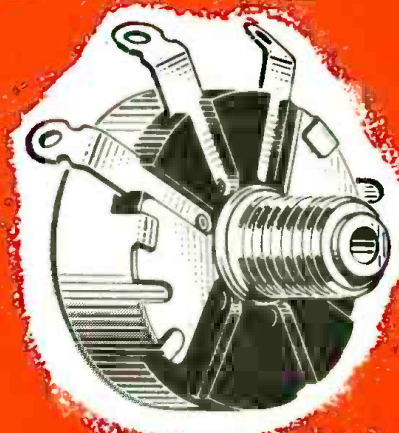

ONE OF THE 70 BASIC  
TYPE D IRC VOLUME  
CONTROLS



NOW THE CONVENIENCE OF 11 IRC TAP-IN SHAFTS!  
—FOR ALMOST EVERY REPLACEMENT NEED.



# Build a Television



Instructor demonstrating rare Schmitt Optical System, used in big picture, projection type, television receivers. This famous television school's location in the heart of the television industry, helps it to get such scarce scientific equipment. At N.Y.T.I. of N.J. all types of television receivers are available for student study.

To stimulate its radio and television training programs, this famous resident radio and television school is offering men interested in television this unusual opportunity.

If you are unable to leave home to go to a resident school, N.Y.T.I. of N.J. can supply you with parts to build a television chassis in your own home. You will be supplied with the same instructions and directions with which the school's resident students are equipped, when they reach the stage in their training that calls for television set construction. If you already have a sound radio background, with experience in building radio receivers, you will be surprised to find how much you can learn about television by building this set.

N.Y.T.I. of N.J. is one of America's leading resident schools for men seeking dependable, thorough, up-to-the-minute training in the various fields of radio and television.

The schooling offered by N.Y.T.I. of N.J. is particularly useful to those who recognize the high-earning possibilities of technical training in radio and television and are willing to tackle the class and laboratory work offered, regardless of their previous education.

No high-school diplomas are needed for entrance. But N.Y.T.I. of N.J. requires that a student be earnest, sincere, and radio-minded. Students without proper mathematical backgrounds are taught the radio and



You can build a direct viewing television chassis similar to the one pictured above, either in your own home or in the magnificently equipped shops and laboratories of this famous television

school, located square in the HEART of America's television manufacturing and broadcasting industry. Mail the coupon at the right to get full details.



# Set Right in Your Own Home!

television mathematics they need. Several students with only grammar school educations have successfully completed advanced technical television courses.

A considerable number of out-of-state students attend the school because of its excellent, practical type of radio and television courses, so difficult to get anywhere else in the world today. Living quarters are obtainable by single students.

## You Put Into Practice Everything You Learn

Students at N.Y.T.I. of N.J. particularly like the way the school puts into practice what it teaches. You may actually build a 17-tube television chassis. You also help build as many as 7 radio receivers of different types, a total of 75 electronic educational devices. Class study, and laboratory study, in the proper combination, increase interest—and your hands get as smart as your head.

A 17-tube, experimental, television chassis may be built by all resident students of television, and may be kept as their own property, if they so choose.

## Located in the Heart of the Electronic Industry

The New York Technical Institute of New Jersey is in Newark, N. J., just across the river from New York City (only 20 minutes from Broadway by subway or train). The school is located in the heart of America's great radio and electronics industry. Such leading television, radio and electronics manufacturers as R.C.A., Western Electric, Du Mont, Federal and Edison are nearby. This means that the school offers numerous advantages, as it is in touch with the most recent developments in radio and television.

Highly qualified television and radio instructors are here in abundance. Equipment is easier to get. Television students are offered exceptional advantages in this great electronic center.

**MAIL THE COUPON  
TO GET FULL  
INFORMATION . . . FREE**

The school issues a special Bulletin which illustrates and describes its truly exceptional facilities and equipment. This Bulletin also describes classes that may be attended, housing conditions, costs, hours, etc. If you are interested in Television—you will want to read this Bulletin. You can have it *free*, merely by mailing the coupon at right.

The school will also be happy to send you complete information about the television kits and directions which are now available to you if you desire to build your own television chassis at home.

Just fill out the coupon at right and mail it NOW to:  
New York Technical Institute of New Jersey, Dept. 42,  
158 Market Street, Newark, N. J.

RADIO-CRAFT for FEBRUARY, 1947



Instructor demonstrating theory of light in connection with study of optical systems used in projection type television receivers. This is just another one of the pieces of equipment which the New York Technical Institute of N.J. has available for resident student instruction.

Big picture television (16" x 21 1/4") in the flesh at N.Y.T.I. of N.J. When it comes to television receivers, N.Y.T.I. of N.J. has it! All types of television receivers are available for student use and instruction at the school.

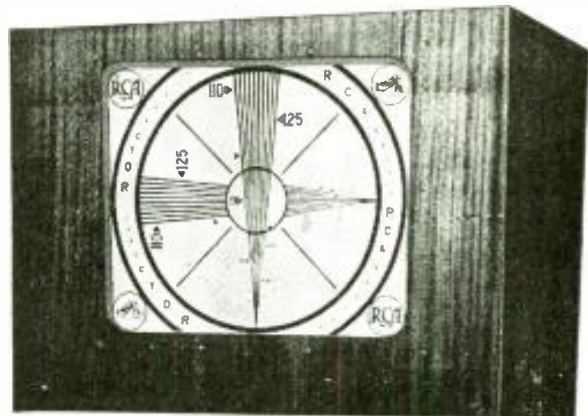

Standard laboratory type test pattern used for determining picture perfection in all types of television transmitters and receivers. (You can see it at N.Y.T.I. of N.J.)

**New York Technical Institute of New Jersey, Dept. 42  
158 Market Street, Newark, New Jersey**

Check here if you wish to receive the Special FREE Bulletin describing the resident school of the New York Technical Institute of New Jersey located in Newark, N. J.—including its facilities, equipment, courses offered, costs, hours, etc.

Check here if you wish complete information about building a television chassis in your own home.

Check here if you are a War Veteran.

Name.....Age.....

Address.....

City.....Zone (if any).....State.....





## BE CONFIDENT WITH A MICROPHONE BY TURNER

Whether it's a general purpose unit for voice and music, or a unit for a specialized application you'll always be confident of accurate pickup and faithful reproduction when your microphone is a Turner. Turner Microphones are proving their superiority in design and manufacture to new users every day.

Illustrated is the Turner Model 33—a high fidelity all purpose microphone that combines high output with smooth response over a wide frequency range. Its matched acoustic design results in crisp, clear speech reproduction . . . music is full and round with tonal qualities faithfully retained. Furnished in a choice of high quality crystal or rugged dynamic circuits. It is recommended for studio recording, remote control broadcast, orchestra pickups, paging, dispatching and call systems, public address and communications work.

### MODEL 33X CRYSTAL

*Response:* Flat within  $\pm 5$ db from 30-10,000 cycles.  
*Output Level:* 52db below 1 volt/dyne/sq. cm.

*Impedance:* High impedance.

*Crystal:* High quality moisture sealed crystal.  
*Stand Coupler:* Standard  $\frac{1}{8}$ "—27 thread.  
*Cable:* 20 ft. removable cable set.

### MODEL 33 DYNAMIC

*Response:* Flat within  $\pm 5$ db from 40-10,000 cycles.  
*Output Level:* 52db below 1 volt/dyne/sq. cm.

*Impedance:* 50 ohms/250 ohms/500 ohms/high impedance.  
*Magnetic circuit:* Heavy duty dynamic cartridge.  
*Stand Coupler:* Standard  $\frac{1}{8}$ "—27 thread.  
*Cable:* 20 ft. removable cable set.



## THE TURNER COMPANY

902 17th Street N. E., Cedar Rapids, Iowa

Licensed under U. S. Patents of the American Telephone and Telegraph Company, and Western Electric Company, Incorporated. Crystals licensed under patents of the Brush Development Company.

TURN TO TURNER FOR THE FINEST IN ELECTRONIC EQUIPMENT

## ?? WHY NOT ??

Why not have the telephone companies devise a telephone that can be used from a distance of two or more feet away? This would make it unnecessary to hold a receiver in your hand. It would enable a woman to chat and do some mending at the same time.

ELIZABETH REHM,  
St. Albans, N. Y.

(Your idea has merit and if there is a sufficient demand for such a device the telephone people will provide it. We were interested enough to interview one of the telephone technical officials, who expressed this view too. For the record, loud-speaking telephones are not a novelty. Indeed, Alexander Graham Bell, himself, in the late 70's used a loud-speaking telephone to demonstrate the telephone. There were many other loud-speaking 'phones in the past—but this was before the day of amplifiers. In the above suggestion if you want to talk back this would mean an amplifier device. Then the phone could be laid on the table and a conversation could be held several feet away from the phone. Technically, the idea is quite feasible.—*Editor*)

Why not design a crystal phono pickup with a universal transformer to match the most commonly used line impedances? It can serve a dual purpose as it can be so mounted as to provide a counterbalance for the tone arm.

PFC. JOHN R. SIMPSON,  
Miami, Fla.

Why not have all autos equipped with a small 1- or 2-tube receiver that delivers its output to a relay which could be used to control the speed of the car. Signals from small transmitters located at busy intersections, schools and railroad crossings, etc. would be used to actuate the control relay.

JOS. P. BROOKS,  
Vallejo, Calif.

Why not have headphones with a good flexible rubber cord? Cloth covered cords kink, fray and short. Rubber cords wear well, seldom kink and are easily cleaned.

PAUL WEISENBACH,  
Cleveland, Ohio

(They were specified in most Army equipment.—*Editor*)

Why not have radios with built-in line filters? This would eliminate the filters that sometimes have to be inserted between the outlet and the receiver.

TROY BLAND,  
Gilmer, Texas

Why not offer an efficient preselector stage as optional equipment on the better class of home receivers? DX and short wave fans should be willing to pay a premium for top performance.

OTTO WOOLLEY,  
Colo. Springs, Colo.



# OLSON FREE

## Gift - of - the - Month Club

**Join Now**  
AND GET THIS MONTH'S GIFT!

**100 CIGARETTES FREE!**

The smokes are on Olson this month! Your choice of Lucky Strikes, Camels, Chesterfields. Smoke 'em or give 'em away. MAIL THE APPLICATION TODAY and you'll get the Olson Gift Coupon!

Do you want the MOST for your money? Do you insist on getting GOOD radio parts? Then the Olson Gift-of-the-Month Club is your dish!

**HERE'S HOW IT WORKS:** (1) Each month you will get a list of Olson Radio Bargains, with a coupon good for the Gift-of-the-Month. (2) Enclose the gift coupon with your order for a low minimum or more, and we will send you the gift FREE. (3) No obligation. You can order or not, as you please, any time.

**HERE'S HOW YOU JOIN:** Just fill out the Application below, mail it, and you're a member. NO DUES — WE PAY THE GIFT-BILL!

**Paste This Application on a Postcard and Mail Today!**

### OLSON RADIO WAREHOUSE

73 E. MILL ST., DEPT. 67, AKRON, OHIO

**Application:** Please enroll me in Olson's Gift-of-the-Month Club. I am interested in getting more value for my money. Membership will cost me nothing.

NAME \_\_\_\_\_

ADDRESS \_\_\_\_\_

CITY \_\_\_\_\_ STATE \_\_\_\_\_

## THE PROBE-TRACER

THE description of the *Dynamic Handful Signal Tracer* in RADIO-CRAFT, November 1945, interested me greatly. You might like to know about a less elaborate one which I devised early in 1945 and have used successfully ever since. Due to lack of radio servicemen in Australia, the authorities licensed a number of experienced amateur radio constructors and others to carry out radio servicing on a part-time basis. As a holder of a part-time license only, and with no intention of taking up servicing as a permanent occupation, I did not want to buy or make too many items of expensive equipment; and with the help of a good multimeter, an oscillator and a tube tester, this simple Signal Tracer carried out all my servicing.

Amateur constructors who have made two or three receivers or amplifiers usually have sufficient practical knowledge to service their own sets and those of their friends. The most common methods used are voltage measurements, with condenser and headphones.

The device shown in the sketch should appeal to many constructors because of its simplicity, low cost and effectiveness. The instrument is easy to build, and the diagrams will give a fair idea of the compact form, though each constructor will probably design a shape to suit the materials available.

It is a hand-held tool having a probe

for introduction into the chassis under test, and two leads, one going to headphones. The probe may be applied to r.f., i.f. or audio circuits. The tracer can be used to listen to the signal at any point. Distortion, hum or noise can be traced to the stage at which it first occurs. The tracer will indicate filtering hum, at the output of the filter if that unit is defective. If screen and cathode by-passes are effective, no signals or very weak signals will be found at cathodes or screen-grids.

The tracer is so sensitive that it need only be brought close to the grid or plate lead of any high level stage. Oscillation of the mixer tube is readily determined, as a signal is obtained from the oscillator grid or plate, which differs from the output signal by the intermediate frequency (that is if a broadcast of sufficient strength, at the oscillator frequency, is receivable by the set). Signals may

be detected at the aerial coil with the tracer volume control well advanced.

Batteries are used because of the simplicity and cheapness of the method. The batteries are wired to a tube socket and the cable from the tracer terminates in a plug which is pushed in the socket when required. No switch is then needed.

From my conversations with many constructors I believe this instrument fills a need. With the addition of a coil, condenser and aerial it becomes a one-tube radio.—Hubert L. Bailey.

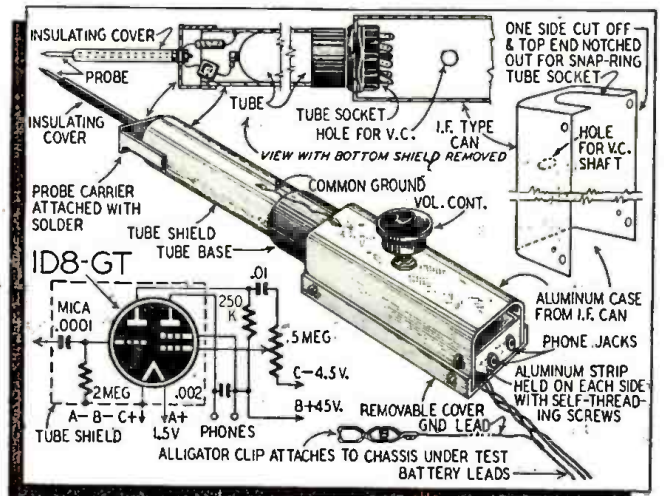



*Just Out!*

# CONCORD Bargain Catalog of RADIO Equipment FOR Immediate Shipment



Just off the press—48 exciting pages of radio parts, equipment, and supplies for dealers, servicemen, amateurs, maintenance, testing, building and experimenting—Thousands of items NOW IN STOCK and ready for IMMEDIATE SHIPMENT! Big feature sections of Radio Sets, Communication Receivers, Amplifiers, Ham Gear, Record Players and Portables, Record Changers and complete Sound Systems. Page after page of bargains and special values in top-quality standard-make radio and electronic parts.

### Mail Coupon NOW for FREE COPY

Mail coupon below TODAY for your FREE COPY of this latest Concord Buying Guide and Bargain Catalog of Radio and Electronic needs you can order for SAME DAY SHIPMENT from complete stocks in Chicago and Atlanta.

# CONCORD

RADIO CORPORATION  
LAFAYETTE RADIO CORPORATION  
CHICAGO 7, ILL. ATLANTA 3, GA.  
901 W. Jackson Blvd. 265 Peachtree St.

CONCORD RADIO CORP., Dept. RC-27  
901 W. Jackson Blvd., Chicago 7, Ill.  
Yes, rush FREE COPY of the new  
Concord Bargain Catalog.

Name.....  
Address.....  
City.....State.....

## RADIO-FREQUENCY LAMP

Since the beginning of the century, ultra-violet rays have been applied in many widely diversified industries and occupations ranging from crime detection and interior decoration to physiotherapy and germicidal purposes.

Common man-made sources of these rays are carbon-arc and mercury-vapor lamps. The carbon-arc generator gives off considerable heat and is inconvenient because the electrodes constantly wear away and require frequent adjustment of the spacing between their tips. The mercury lamp has metal electrodes sealed in the ends of a quartz tube containing mercury vapor. An electric current is passed between the electrodes and the vapor ionized, releasing quantities of ultra-violet rays. The main difficulty with these tubes was the gradual breakdown of the electrodes with subsequent reduction in the ultra-violet output. There was no way of determin-

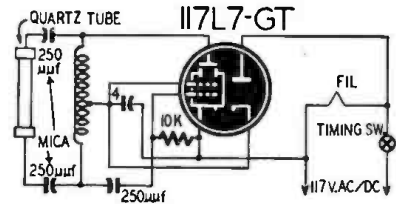

Fig. 1—Power supply for ultra-violet lamp.

ing the useful output of the lamps and they were often used long after their useful life had expired.

This handicap to users of ultra-violet ray equipment has been overcome by use of a special quartz tube and an r.f. oscillator. This tube has been produced in several sizes and for industrial and therapeutic purposes. The smaller sizes are available as "sun lamps" for the homes. Photo below shows one of the lamps. This lamp uses a quartz tube that has been exhausted to a high vacuum and filled with argon, neon or other inert gas, along with a small globule of mercury. When the tube is placed in a strong radio frequency field, some of



Courtesy Sun-Kraft, Inc.

Complete lamp. Power supply unit is in base.



the mercury vaporizes and the tube conducts current. The resulting ionization is a source of ultra-violet rays.

A simple 1-tube r.f. generator, shown just below, is used to excite the lamp. It is small enough to be housed in the base, thus eliminating bulky high frequency induction coils and power supplies.

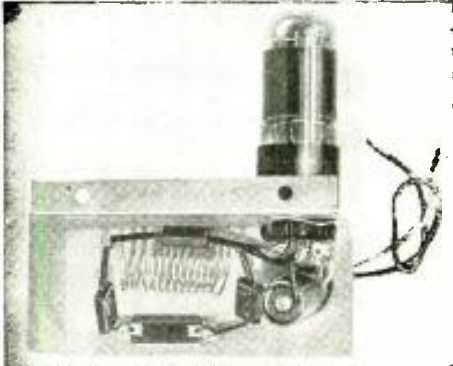

Underchassis view of single 117Z6 oscillator.

This generator, Fig. 1, uses a single 117L7GT tube as rectifier and r.f. oscillator. The circuit is a series-fed Hartley operating between 16 and 20 mc. The coil consists of 12 turns of No. 18 wire wound to a diameter of 3/4-inch and spaced to about 1 3/4 inches. The coil is tapped four turns from the grid end. The quartz lamp fits into clips connected across the coil with 250-μmf mica condensers at each end to prevent d.c. voltage from reaching the lamp.

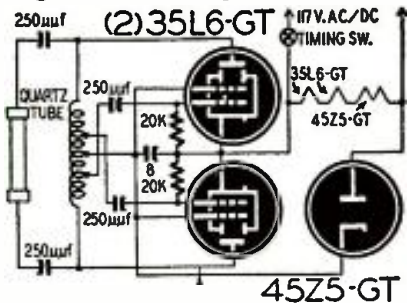

Fig. 2—Push-pull supplies more power output.

When more r.f. voltage is required, the circuit in Fig. 2 may be used. In this instance, push-pull 35L6's are used in the same basic circuit with the plate voltage supplied by a 45Z5-GT rectifier. The available r.f. voltage from this circuit is twice that produced by any single-ended oscillator using the same plate voltage. The coil in this circuit uses 11 turns of No. 18 bare-tinned copper wound to a diameter of 3/8-inch and spaced to 1 1/2-inch. Taps are connected 2 turns each side of center.

A small timing switch is built into the base of the sun lamps so that the operating time may be pre-set to prevent over-exposure to the ultra-violet rays.

Cigarette paper absolutely free of leaks is made by a process developed by General Electric. The paper acts as insulator between two conducting rolls with high voltage between them. An air-hole or piece of foreign matter of lower resistance than the paper causes a flash-over, which is indicated by an alarm bell or lamp.

# GET YOUR FCC Commercial Radio Operators' LICENSE Now...

**How To Pass  
FCC  
LICENSE  
EXAMINATIONS**  
CLEVELAND INSTITUTE  
OF  
RADIO ELECTRONICS  
Terminal Tower - Cleveland, Ohio

**Don't Delay—  
Write Today!**

## It's Easy If You Follow Our Plan

Thousands of new jobs are opening up—**FM, TELEVISION, MOBILE COMMUNICATION SYSTEMS**, are only a few of the new radio fields which require licensed operators.

**FREE BOOKLET** Tells you the Government requirements for all classes of commercial operator licenses. Tells where to apply for and take the examinations, examining offices, scope of knowledge required, extracts from FCC Rules and Regulations, extracts from FCC Study Guide and Reference Material, approved way to prepare for FCC examinations, positive method of checking your knowledge before taking the examinations.

*Edition Limited—Mail Coupon Before Supply Is Exhausted*

## CLEVELAND INSTITUTE OF RADIO ELECTRONICS

CONTRACTORS TO THE CANADIAN BROADCASTING CORPORATION  
Successors to

NILSON RADIO SCHOOL  
Founded 1939

SMITH PRACTICAL RADIO INSTITUTE  
Founded 1934

RC-2 TERMINAL TOWER, CLEVELAND 13, OHIO

Approved for Veteran Training Under "G-1 Bill of Rights"

MAIL THIS COUPON

### CLEVELAND INSTITUTE OF RADIO ELECTRONICS

RC-2 TERMINAL TOWER, Cleveland 13, Ohio

Gentlemen: Please send your FREE Booklet, "How To Pass FCC License Examinations."  
(Note: This Booklet does not cover examinations for Amateur License)

NAME ..... I have had experience in broadcasting  
 servicing  operating   
 mfg.  CAA  Army-Navy   
 amateur  other .....

ADDRESS .....

CITY ..... STATE .....

Check license desired:  
 Radiotelephone  1st. Class  2nd Class  
 Radiotelegraph  1st Class  2nd Class

I am a  High School Grad. College Grad.  with degree .....

I now hold these licenses ..... If a War Veteran, check here

### REPAIRING CRACKED CRYSTALS

Electrically and mechanically, the most fragile component of a radio transmitter is its frequency-controlling crystal element. When used to control a high-power oscillator, it heats up and eventually may crack. We have some which have given way after many years of satisfactory operation in numerous experimental as well as conventional hookups.

We find that ordinarily a cracked crystal ceases to oscillate. However, a broken crystal whose surface is otherwise unmarred can continue to oscillate if mounted under rather light pressure. For example, we have one small fragment (about 1/2 by 1/4-inch) of a 40-meter crystal which cannot be made

to oscillate when mounted in the new-style (octal-socket) holder which uses heavy pressure. When placed in an old-type round Bliley holder, however, it operates almost as well as did the one-inch crystal of which it formed a part. This Bliley holder has an adjustable pressure, an important feature for our purpose.

Maximum output and most stable performance is obtained by decreasing the adjustable pressure against the crystal until the oscillator output is greatest. Then the pressure is increased slightly to keep the crystal from moving about. It may be necessary to round off any jagged corners or edges.

—I. Queen



# TRANSFORMER WINDER



**ALLIED**  
*Sound for '47!*

**New 30 WATT DeLuxe  
PORTABLE P. A. SYSTEM**

Here's a preview of ALLIED Sound for 1947 in this smoothly-styled, brilliantly engineered 30 Watt De Luxe Portable System. New stabilized inverse feedback circuit delivers high output, usable right up to its peak. Flexible operation is provided by two microphone and one phono channels, each with separate control. Has bass-treble tone control. Amplifier and speakers are safety-fused. Amplifier gain on microphone is 128 db; on phono, 80 db. Frequency response: 50-10,000 CPS. System covers up to 4,000 persons, or up to 20,000 square feet.

**Complete 30 Watt System includes:** 30-Watt De Luxe Amplifier with tubes; 2-12" Safused Dynamic Speakers, with 30-ft. cables and plugs; 1-Cardax Unidirectional Microphone with floor stand and 20-ft. cord and plug. Complete in handsome luggage-type split portable carrying case, 22"x20"x15". Carrying wt., 60 lbs. For 110 volts, 60 cycles A.C. (Less phono top and volume level meter which are optional.)

**Complete System (approximate price) Only ..... \$99.50**

**ALLIED**  
*For Everything  
in Radio and  
Sound*

See your ALLIED Catalog No. 111 for the world's largest and most complete stocks of quality radio and sound equipment—at today's lowest prices! Count on ALLIED for fast service, expert help. If you haven't a copy of Catalog No. 111—send for it now—it's FREE for the asking.

## ALLIED RADIO

ALLIED RADIO CORP.

833 W. Jackson Blvd., Dept., 2-B-7, Chicago 7, Ill.

Ship 30-Watt Portable System described above. \$..... enclosed.

Send full details on ALLIED Sound.

Send FREE Radio Catalog No. 111.

Name.....

Address.....

City..... Zone..... State.....

WHEN it comes to a show-down anyone mechanically inclined can duplicate almost any gadget or machine from junk parts that clutter up his shop. This electric coil winder was built entirely from scrap bits by the radio repairmen of the 3124th Signal Service Co. when they were stationed in Ghent, Belgium, during the war. It came in handy when burned-out transformers weren't replaceable and impedance-matching transformers were needed to balance off-color foreign equipment with our own "standard" apparatus.

In Europe burned-out transformers were the biggest problem. Most cities had so many different voltages that it was impossible to use any equipment without first knowing what commercial voltage was used. Antwerp, Belgium, was the best example with six: 110 volts, 220 volts and 240 volts, on both a.c. and three d.c. People who moved from one part of the city to another (sometimes only across the street) had to exchange their electrical appliances for those of the new voltage. Some buildings had both a.c. and d.c. outlet plugs—you could never be sure.

The electric coil winder helped over the rough spots and cut down the working hours per job tremendously. It was made from odds and ends of military equipment but a civilian shop has comparable junk. The winder was powered with an old phonograph motor geared down with gears taken from a burned-out hand generator from an army EE-8-A field telephone. The number of turns was counted with a Veeder counter from a radio transmitter dial taken from a sunken Liberty ship that went down in the English Channel.

Those are purely the mechanical winding parts, the level wind guide is something else. It permits winding each layer on straight and close. As shown in the illustration, the operator sits by as the coil is being wound. His right hand is on a crank (taken from the same field telephone generator) which he must turn to achieve the level wind. What he actually turns is a threaded shaft, a rod that has been threaded its entire length. Over this fits a little threaded slider that screws on the threaded shaft so that when he turns the crank in one direction or the other the slider moves up or down along the shaft.

In the illustration the threaded shaft is the one above, the one attached to the crank. The lower shaft, which is the same size, merely acts as a guide and keeps the slider, which is the piece half way between the two uprights, from rotating with the upper shaft.

The slider has a small grooved pulley attached to it over which the wire runs just before it winds onto the transformer. Thus by turning the crank at the proper speed and in the proper direction, the wire moves along the coil surface and level wind is achieved with surprising ease.

The reason the level wind guide is hand-operated is that too many sizes of wire were used. Had the winder been mechanically fed each size would require a new gear system to move the wire along at a different speed. Had hundreds of coils been needed, it could have been mechanically operated, but for the few dozen required it did the work of a factory winder, at a slightly lower speed.

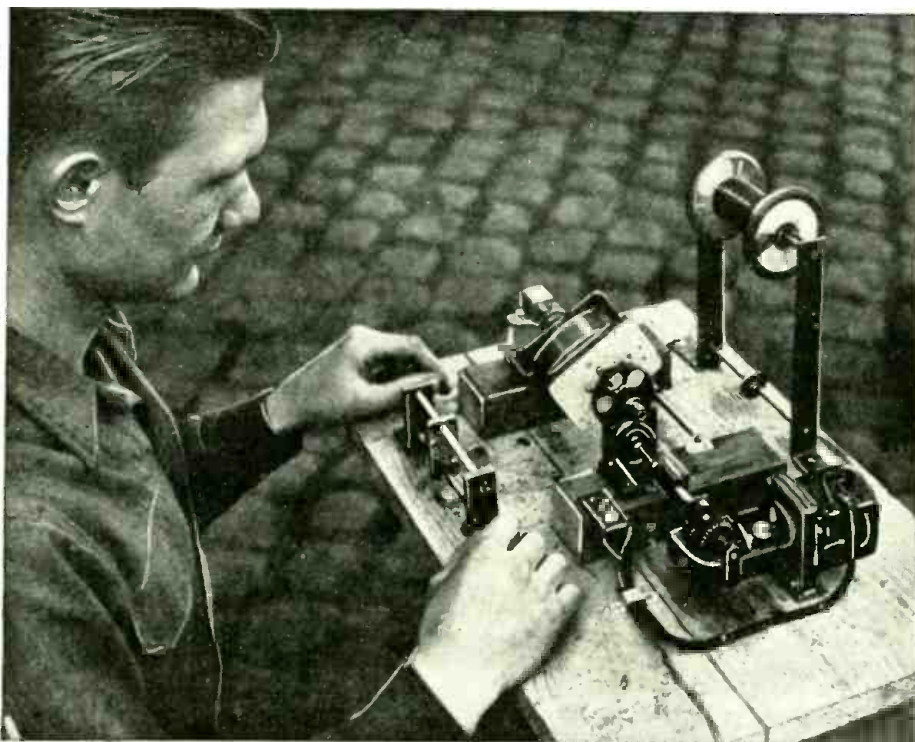





*Will You* be a Trained Radio-Electronics Technician holding a highly - skilled, well paid position? . . . *? OR Will You* be just another serviceman who "muffed" his BIG opportunity back in '47. *?*

Foresighted radio servicemen are looking ahead to the future. A future that has unlimited opportunities and real profits for those who have the "Know-How" to SERVICE television, FM, industrial electronic equipment, and the many other new radio developments.

Join the many professional servicemen who are studying at home, the new developments, the new techniques, with CREI . . . protecting their future jobs, their businesses by acquiring the new "Know-How," NOW!

CREI's reputation for some study training has been proved over 19 years. Important new developments

(VETERANS! CREI training is approved under the G.I. Bill)

## Capitol Radio Engineering Institute

An Accredited Technical Institute

Dept. RC-2, 16th and Park Road, N. W., Washington 10, D. C.

Branch Offices:

New York (7): 170 Broadway

San Francisco (2): 760 Market St.

have been included in our present course. Trained instructors give you personalized attention and guidance *all the way*.

Find out for yourself how CREI can help you to greater security and prosperity. Send in the coupon now! Actually see what CREI has to offer.

### PERSONAL IMPEDANCE

While lots of fellows always agree with good advice, somewhere within them there is an apparent resistance to it, that keeps them from acting soon enough. Don't be one of them. To assure your professional future acquire today all the knowledge, experience and training you possibly can in the new developments in Radio-Electronics.

*E. N. Pfeiffer*  
President of CREI



If you have had professional or amateur radio experience and want to make more money, let us prove to you we have the training you need to qualify for a better radio job. To help us intelligently answer your inquiry—PLEASE STATE BRIEFLY YOUR BACKGROUND OF EXPERIENCE, EDUCATION AND PRESENT POSITION.

GROUND OF EXPERIENCE, EDUCATION AND PRESENT POSITION.

**MAIL  
COUPON  
FOR FREE  
36-PAGE  
BOOKLET**

CAPITOL RADIO ENGINEERING INSTITUTE RC-2  
16th and Park Road, N.W., Washington 10, D.C.

Gentlemen: Please send me your free booklet, "Your Opportunity in the New World of Electronics," together with full details of your home study training. I am attaching a brief resume of my experience, education and present position.

NAME .....

STREET .....

CITY ..... ZONE..... STATE.....

OCCUPATION .....

I am entitled to training under the G.I. Bill.



# The Question Box to Radio Craft

The Question Box is again undertaking to answer a limited number of questions. Queries will be answered by mail and those of general interest will be printed in the magazine. A fee of 50c will be charged for simple questions requiring no schematics. Write for estimate on such questions as may require diagrams or considerable research.

## INTRUDER ALARM

Please print a diagram of a burglar alarm using OA4-G gas triodes, in a capacity-operated circuit. The capacity antennas are to be placed at the windows and doors of my home to sound an alarm when anyone approaches from the outside.—J.O.H., San Diego, Calif.

A. Here is a diagram of a capacity-operated alarm drawn to your specifications. A capacity wire of screen is

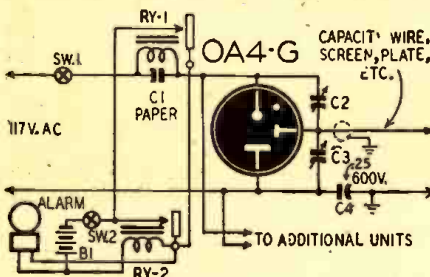

placed in the area to be protected. A grounded metal shield or baffle may be mounted about 6 inches from one side to reduce sensitivity from one direction. These tubes have a photo-electric characteristic and should be shielded from light. After relay, Ry-1 has been tripped, the alarm will ring until Sw2 is opened to reset Ry-2.

Ry-1 is a 5000-ohm plate relay and Ry-2 is a small 6-volt d.c. relay.

## SIMPLE TUBE TESTER

Please print a diagram of a simple tube tester showing the socket wiring

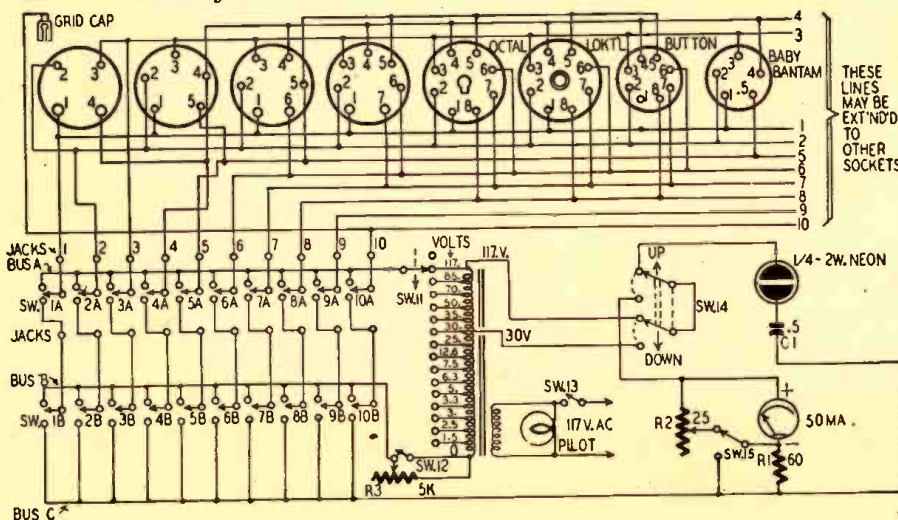

connections for testing all types of tubes.—L.P., Long Island, N. Y.

A. Here is a complete diagram of a tube checker showing the connections for all commonly used sockets and for all switches.

To test any tube, it is necessary that you refer to a tube manual to get the socket connections. Filament voltages are selected by Sw-11. The tube is plugged into the socket and filament voltage applied by throwing the proper switches to connect the filament leads to busses A and B. If there is a cathode, it is also connected to bus B. For emission tests, all other elements are connected to bus C. In testing full-wave rectifier tubes and duo-diodes, each plate is tested in turn by connecting it to bus C.

The check is calibrated by testing tubes of known quality and recording the dial readings and setting of R2.

Further operating and calibrating instructions may be found on page 35 of *Home-Made Radio Test Instruments* and on page 25 of the July 1940 issue of *RADIO-CRAFT*.

## V.T.V.M. CIRCUIT

I am planning to build the Multi-Purpose Tester described on page 534

of the May issue. I would like to have a diagram showing how I may use a 0-200 microampere meter in a vacuum-tube voltmeter circuit.—J. B., Newark, N. J.

A. A vacuum-tube voltmeter may be added to the tester. A 6Q7 is used. Plate voltage is obtained by tapping the power positive lead at J9 on the tester. R2 is adjusted so that there will be 250 volts on the plate of the 6Q7. It may be necessary to experiment with the value of R1 to obtain initial calibration.

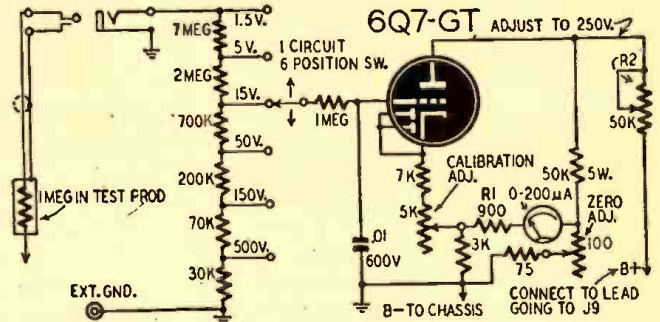

From this point on, the Calibration Adjust control will be used for corrections of the calibration.

The meter is connected so that it may be used with a zero-center scale so that measurements may be made without regard to test lead polarity.

## A.C.-D.C. POWER SUPPLY

Please print a diagram of an a.c.-d.c. power supply for use with small audio amplifiers.—V.P.B., Lyndonville, N. Y.

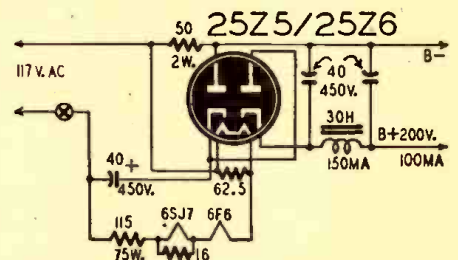

A. The circuit of a half-wave voltage doubler is shown. This circuit, using a 25Z5 or 25Z6, will supply 200 volts at 100 ma. The total current drawn by the 6F6 and 6SJ7 will seldom exceed 40 ma, so the output voltage will be about 240 volts.



## RADIO PROGRESS IS SLOW

(Continued from page 17)

experience that it will take many years to develop a new device and that in the process all or most of the original capital may be lost if further capital is not forthcoming. There are many cases on record where initial investments of \$50,000 grew to over a million dollars before the device finally appeared on the market. During that process the original investors were forced to give up most of their share in the device, if they were not to lose everything. Often the first investors *did* lose everything and the original company went into bankruptcy. Subsequent investors then stepped in, bought the assets, and financed the project until the device was finally placed on the market. Pioneers thus more often than not lose out only to have others who are better capitalized take over and market the invention. All of this is normal evolution typical not only of radio, but also of any other endeavors. It is a rare device in which the original investor reaps the fruits of his labor.

The above facts should be kept in mind when you wonder why new radio inventions that should have been on the market long ago have not materialized.

Take just one—the vest pocket miniature radio sets—promised now for several years by some radio manufacturers. Technically we seem to have all the requirements to build these receivers. Practically and economically, however, it may take some time before they will be on the market. There are still a great many "bugs" to be ironed out. Miniature radio tubes still have to become smaller and more efficient and sensitive. Different circuits must be evolved. Miniature variable condensers are yet to be perfected. Moreover, normal radio set manufacturing processes are not applicable to vest pocket sets. They cannot be produced like regulation radio receivers simply because they are too small. Assembling them becomes more or less a watchmaker's endeavor. New workers must be trained for an entirely new kind of assembling job which never existed before. There is also a cost angle in connection with this item, because no one is going to pay \$50.00 or more for a vest pocket set. In order to bring the cost down a slow evolutionary process must be gone through. All these problems will be solved eventually, but it always takes time.



## Dial Belt Kits - Phone Needle Packet Ruf-Koat - Dial Cable Racks - Lite-Koat Kit

### G-C Ruf-Koat Air Dry Wrinkle Finish



The only wrinkle finish that will air dry without baking. Easy to use. Gives professional wrinkle finish. No. 60-2—1/8 pt. List 45c

### G-C Servicemen's

**Phono Needle Packet**  
For every serviceman to carry on calls. Sell needle replacements with this handy packet. Contains ten needles, two each type and two recording stylus. No. 1432, List \$8.50



### G-C Servicemen's Dial Belt Kits

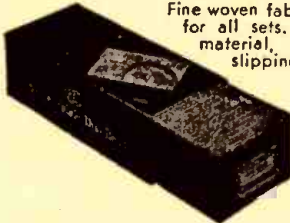

Fine woven fabric replacements for all sets. Made of finest material, no stretch, no slipping, easy to install. Supplied in kits of various quantities, with steel box. No. G-25-Kit of 25 belts List \$6.70



### G-C Servicemen's Dial Cable Racks

Convenient to handle radio dial cables. Hang rack which has 10" ruler, easy to measure cable. Spools wind independent of other spools. No. 7-A-25-rack, ruler 5-25 ft. spools ..... List \$5.58

### G-C Luminous Lite- Koat Kit "Glow in the Dark"

Long-life, luminous, safe coating that emits light in the dark. Ideal for office, home, etc., many uses. No. 184-0 Deluxe kit—powder, mix-koat, top-koat, brushes and thinner ..... List \$2.50



### G-C Ne-O-Lite Tester

Handy, inexpensive Ne-O-Lite Tester that every one should have for countless uses. Can be used on 60 V.A.C. to 500 V.A.C. or D.C. No. 5100—single tester on card ..... List 50c



AVAILABLE AT LEADING DISTRIBUTORS.  
WRITE FOR CATALOG TODAY.

RADIO DIVISION DEPT. D

**GENERAL CEMENT** Mfg. Co., Rockford, Ill., U.S.A.

Manufacturers of over 3,000 products • Sales offices in principal cities

## The Nationally Known HOLLYWOOD BROILER

Here's the finest broiler made. It has an easy to handle cover, an attractive finish, comes complete with rack and cord. It has two heats and is roomy enough for the largest roast.

**12.95** each. **12.50** in lots of 6



## HOT PLATE

3 heat, two element, mounted on attractive metal stand. Three Switches Control all Heats. Complete with cord.

Net price **6.50** each. Lots of ten **5.95** each.

FOR ROOMS . . .  
FOR STORES . . .  
FOR GARAGE . . .

### RADIATION TYPE HEATER

This cone shaped heater has replaceable element, and is 100% safe. Comes complete with guard.

**4.95** each. . . In lots of six **4.45**

### 2 SPECIAL VALUES

Representative Values From Our Complete Radio Parts Stock.

• 5" P.M. speaker. Alnico slug . . . 3 to 5 ohms

• . . . voice coil.

**1.59** each. . . . 10 for **14.90**

• Output Transformer. Clnch or Screw Type. Can be used with 50L6 . . . 35L6 . . . 25L6.

**49c** each. . . . . 10 for **4.50**

Write us about your needs in Radio Parts, Testing and Sound Equipment, and Electrical Appliances.

Send for Our Latest Catalog

**RADIO PARTS COMPANY**

612 W. Randolph, Dept. "C", Chicago, 6, Illinois



it's New...

it's BIG

it's FREE



# LAFAYETTE'S latest, greatest RADIO CATALOG

**Y**es, here it is at last—the most complete catalog ever offered by Lafayette—the world's largest radio supply house. And what a catalog it is! Its pages are brimming with an amazing display of top-quality radio and electronic equipment—such items as radio parts, complete sets, build-it-yourself kits, amplifiers, microphones, automatic record changers, ham gear, test equipment—as well as hundreds of other items.

144 PAGES — HANDSOMELY ILLUSTRATED

All the tried-and-tested standard equipment is listed—also many items so recently developed that they're shown here for the first time. And everything is in stock—ready for super-speed delivery—economy priced. Be among the first to get your copy of America's greatest radio catalog — FREE.

mail coupon below

## Lafayette Radio

RADIO WIRE TELEVISION INC.

100 SIXTH AVENUE • NEW YORK 13, N. Y.  
110 FEDERAL STREET • BOSTON 10, MASS.  
24 CENTRAL AVENUE • NEWARK 2, N. J.

LAFAYETTE RADIO, Dept. JB-7  
100 Sixth Avenue, New York 13, N. Y.

Please send FREE CATALOG at once to:

Name.....

Address.....

City..... Zone..... State.....

### typical Lafayette BARGAINS

 Heavy-Duty Filament Transformer — Two secondary windings—10 volts of 13 amps CT and 7.5 volts of 2.5 amps CT. Size 3 1/2" x 5" x 7 1/4" H. Only a few available at this low price. Order NOW from this ad. HR 314—Filament Transformer—Your cost only \$2.95

 Famous Leach Relay — Type 1177CPS — All-ceramic insulation—DPDT with separate SPDT contacts for break-in. Ideal for antenna changeover. 115-volt, 60-cycle coil. They're going fast — so order AT ONCE. HR 120 — Leach Relay — Your cost only \$1.95

### SMALL RECORDING STUDIO

(Continued from page 27)

up patterns of the most common types.

Now that we have an idea of what we need as a minimum for our studio, let us see how those items are coordinated by studying an actual setup which was assembled by the author.

After much shopping around, a two speed 16-inch Rek-o-Cut model D-16 turntable was purchased. This model comprises a heavy cast-iron turntable, rim driven through heavy rubber idlers by a 1/20 horsepower induction motor. The speed-change knob is conveniently located and easily operated without stopping the turntable. The rumble is very low and there is negligible speed change under cutting load.

The turntable assembly was rigidly bolted to the top of a wooden Sears & Roebuck sink cabinet. It is not good practice to float the table in rubber, but rather it is desirable to fasten it solidly to a rigid base. The attendant damping is valuable in removing the motor vibration.

There were not a great variety of overhead assemblies available, so a second-hand 12-inch Universal overhead was acquired and modified for 16-inch duty. The modification included turning new longer lead screws for inside-out and outside-in operation, and a long support bar. The method of overhead drive was changed also. By now a good overhead system can be purchased for \$150.00 or less, and at least one is advertised for less than \$50.00, including cutter.

There is usually quite a lineup problem in adapting an overhead to a turntable. This problem was simplified by using a single ball bearing as the resting place for the overhead on the turntable center pin. The overhead is driven by an arm which is contacted by the drive pin in the turntable. It is impossible for a slight mal-alignment to cause binding and the annoying attendant wow.

In the interest of cost, a Brush RC-20 crystal cutter was used. It was attached to the carriage by a 1/8-inch stainless steel bracket. There was a tendency toward bouncing of the head, so a viscoloid damper was added, together with an eight ounce weight, to lower the resonant frequency of the carriage. The photo shows the drive mechanism and the finished cutter assembly.

Because we chose a crystal cutter, we also chose a crystal pickup. A Brush PL-20 is a very well constructed pickup. Its response is good to beyond 10,000 cycles per second. It is of the low-pressure permanent sapphire type, with a spring counterbalanced arm. It was supplied with an equalizer which corrects for commercial modified constant-velocity recordings.

An amplifier on hand was modified to provide the necessary characteristics for recording. The modified am-

(Continued on page 77)



## HIGH SPEED PHOTO FLASH

(Continued from page 23)

ture bulb is suitable for this application (see Photo D). Incidentally, no trouble has occurred through operating this bulb on 9 volts, since it carries a 6- to 8-volt rating. A 6-prong cable carries connections between camera and power unit. Ordinary 6-wire speaker



Photo F—Underchassis view shows power socket.

cable has been employed successfully with the unit shown in Photo E. However, insulation should be adequate and it is a good plan to dip the cable in insulating varnish if it is of the woven fabric covered type.

A unit of this type should be wired with the very best hookup wire available. Ordinary radio pushback wire is unsuitable as it simply will not carry the high voltages present in this type of equipment. Use wire having flame-proof glass, rayon braid, or similar insulation, capable of handling 2,500 volts. Use only rosin solder. The least bit of

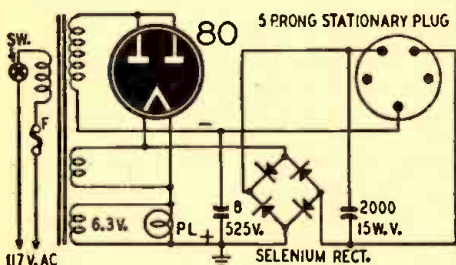

Fig. 4—Diagram of the a.c. power supply unit.

acid will cause a flashover, especially in the switch contacts, and such a flash-over may ruin the equipment.

While not particularly dangerous when in the Charge position, the output from the condensers is positively not to be trifled with when in the series or discharge position. Hence, all testing must be done with due caution to avoid getting a serious, perhaps fatal, shock. The main switch should always be returned to the Off position or to the Charge position before removing the

# HARRISON HAS IT!

# HARRISON HAS IT!

Vy 73 to you, OM for a Joyous Christmas and a Productive New Year!

Bil Harrison, W2AVA

## HARRISON SELECT SURPLUS

Your assurance of good, usable, guaranteed, surplus material at sensationally low prices—TOP VALUE ALWAYS! Come in and browse through our large HSS Department.

### ● COMPACT VIBRATOR PACK

FB for transceivers, portable receivers, etc. Delivers 135 volts at 80 ma; 67½ volts at 3 ma; 1.5 filament or 0.3 heater, bias, and microphone voltages.

Completely filtered—neon tube voltage regulator—remote load-start relay—ruggedly made for dependable Navy use. 1½" x 3¼" x 4". Weighs only 2 lbs. Works on any 6 volt DC source.

Complete vibrator pack, less only battery (use it on four flashlight cells, your car battery, etc.) ..... **\$3.95**

With a clip-in RECHARGEABLE Willard Storage Battery. Unbreakable, NON-SFILL, plastic case (110 V AC .2 Amp. Trickle charger) ..... **\$5.50**

With TWO clip-in Willard Primary batteries. (See our Jan R-C ad) ..... **\$5.75**

### ● HSS EQUIPMENT BARGAINS

Brand new, with diagrams and instructions

R 45/ARR-7—Airborne version of the Hallcrafters SX-28A Super Skyrider receiver. With crystal filter and tubes, less power supply ..... **\$137.50**

RAK-7. Navy long wave TRF receiver, 15 to 600 KC. With AC power supply. 9 tubes ..... **\$59.50**

BC-406—15 tube RECEIVER. Slightly used (BC-406A—\$29.75) ..... **\$19.95**

Easily converted to a hot superhet ham receiver. See our previous ads.

Code Practice Oscillator AN/GSC-TL Works on 110 Volt AC, etc. in carrying case. **\$14.95**

Dynamotor. Runs on 6 or 12 volts. Delivers 500 volts at 180 MA. From PE103 Power Pack **\$9.95**

### ● PANORAMIC

Add "eyes" to your receiver with a Hallcrafters Panoramic adaptor and increase your operating efficiency and QSO score. Complete with ten tubes and instruction ..... **\$99.50**

### ● TELESCOPING ANTENNA

Signal Corps AN29-C. Sturdy, lightweight, brass antenna extends to 12' 10". telescopes to 15", ¾" diameter. Weighs only 80 oz. FB for mobile, or rotary beam elements. **\$1.95** each. Six at **\$1.74**

## ALL STANDARD LINES

We are Factory Authorized Distributors for the top quality manufacturers and we now have in stock lots more new, latest, improved production Ham gear! Visit our stores today, for everything you need. We promise you fresh, clean material—quicker—at the lowest current prices—and above all, our sincere desire to be of friendly, helpful service.

As one of the world's largest distributors of Communications Equipment, we are delivering plenty of

## RECEIVERS

Right Now! ALL MAKES—practically all models. If you want your new set in the quickest possible time send your order to HARRISON! For example:

**HALLCRAFTERS—**  
S-38 ..... \$39.50 .. S-40 ..... \$79.50  
S-36A. FM-AM-CW—27.8 to 143 Mo. .... \$97.50  
S-37—130 to 210 Mc. .... \$91.75  
SX-42—New FM-AM. .54 to 110 Mo. .... \$250.00

**HAMMARLUND—New "Super-Pro"**  
SPC-400-X—55 to 30 Mc. .... \$34.05  
Speaker in Cabinet—\$13.20

HQ129X, complete with speaker in cabinet.... 173.25

**NATIONAL—**  
NC-240 D—Complete with speaker. .... 241.44

HRO-ETA-1—Complete with Pack and Speaker 303.00

RME-45—Complete with speaker. .... 198.70

RME-84—Complete with speaker. .... 98.70

LITERATURE ON ANY RECEIVER GLADLY SENT UPON REQUEST

### ● TEMCO 500 GA

A conservative 750 watts output on all bands—Phone and CW! Rock stable VFO—simplified tuning—FB value in a post-war rig!... **\$1800**  
Temco 75 GA ..... \$495

We have a limited quantity available for immediate delivery

### ● TWO METERS IS FUN!

New RTL compact Handle-Talkie. Pull out the antenna and you're on the air... **\$31.50**  
(Complete with tubes and batteries—\$35.95)

Abbott TR-4B. New, post-war model. FB for mobile or fixed station! ..... **\$52.00**  
(Complete mobile station, less only antenna—\$81.61)

**MAIL ORDERS? Certainly!** Just list everything you want (items in this ad, or any ad, magazine, or catalog) and include remittance. Prompt Shipment.

Vy 73 de

Bil Harrison, W2AVA

**HAM HEADQUARTERS**  
Since 1925!



**HARRISON RADIO CORPORATION**

9 WEST BROADWAY • NEW YORK CITY 7

PHONE—BArclay 7-9834 • EXPORT DEPT.—CABE—HARRISONRAD

JAMAICA BRANCH—172-31 Hillside Ave.—REpublic 9-4102

unit from the case or touching any part of the internal mechanism.

The 117-volt power unit (Fig. 4) furnishes 500 volts for charging the capacitors, and about 8 or 10 volts for tripping the relays. It would be easily possible to make a unit to deliver only the low voltage, but it was thought desirable to include the high-voltage output to save wear and tear on the vibrator power supply. Another important consideration is the bulk of a unit designed to furnish the 9-10 amp required at 9 volts. Note that the transformer secondary (high voltage) is connected to an 80 tube for half-wave rectification. With a small 4-tube transformer, voltages should be about correct with the two filament windings in series and using all the high-voltage plate wind-

ing. Should the plate voltage be excessive a series resistor or voltage dividing network may be required. Output plate voltage must not exceed 500.

The low-voltage rectifier may be of the type used in a battery charger, or it may be one of the types found on an old loudspeaker since current drain is low. Usually it will be of the full-wave type, so connections may be altered accordingly if necessary. With the large capacity (2,000 μf) the rectifier output may be very small, since the capacity of the condenser is sufficient to trip the relays.

Note the method of connecting the power unit through a 5-prong plug so that batteries and vibrator are disconnected when the shorting plug is removed and the power unit plugged in.



# General Electronic

DISTRIBUTING COMPANY

THE NATION'S  
HEADQUARTERS  
FOR ELECTRONIC  
EQUIPMENT!

## SEE and HEAR the Signal with the new CA-12 SIGNAL TRACER



**FEATURES:**  
 • Comparative intensity of the signal is read directly on the meter—Quality of the signal is heard in the speaker.  
 • Simple to operate—Only one connecting cable—No tuning controls.  
 • Improved vacuum-tube voltmeter circuit. \*Tube and built into the detector probe. \*Built-in high gain amplifier—Alnico V speaker. \*Completely portable—Weights 8 pounds—Complete with self-contained batteries and instructions

\$34.85

## The New Model 450 TUBE TESTER



**SPEEDY OPERATION** assured by newly designed rotary selector switch which replaces the usual snap toggle or lever action switches.  
**Specifications:**  
 • Tests all tubes up to 117 Volts.  
 • Tests shorts and leakages up to 3 Megohms in all tubes.  
 • Tests individual sections in multi-purpose tubes.  
 • New type line voltage adjuster.  
 • Noise Test: Tip jacks on front panel for plugging in either phones or external amplifier will detect microphonic tubes or noise due to faulty elements and loose internal connections.  
 • Works on 90 to 125 Volts 60 Cycles A.C.  
 Complete with all operating instructions

\$39.50

## The New Model 670 SUPER METER

A Combination VOLT-OHM MILLIAMMETER plus CAPACITY REACTANCE INDUCTANCE and DECIBEL MEASUREMENTS.

**Added Feature:**  
 The model 670 includes a special GOOD-BAD scale for checking the quality of condensers at a test potential of 150 Volts. Complete with test leads and operating instructions

\$28.40



## The New Model B-45 SIGNAL GENERATOR

Self-modulated—provides a highly stable signal. RF frequencies from 150 Kc. to 12.5 Mc. on Fundamentals and from 11 Mc. to 50 Mc. on Harmonics. Modulation is accomplished by gridlocking action—equally effective for alignment of amplitude and frequency modulation as well as for television receivers. Self-contained batteries. All calibrations are etched on the front panel. Complete, ready to operate

\$27.75



TERMS: 20% DEPOSIT. BALANCE C.O.D.

## Our Policy

All units are sold subject to one year guarantee except when components are damaged through misuse.

We do not solicit orders for any unit that does not meet our requirements for accuracy and honest value. Any item purchased from us is sold with the understanding that it may be returned for full refund after a 10 day trial.

MAIL TODAY  
FOR FREE  
COMPLETE TEST  
EQUIPMENT  
CATALOG

GENERAL ELECTRONIC DISTRIBUTING CO.  
98 PARK PLACE, NEW YORK 7, N. Y. (Dept. R.C.)

Please send me a FREE copy of your complete Test Equipment Catalog.

Name .....

Address .....

State .....

City .....

# SILVER "VOMAX"

WITH  
YOU CAN—



Post-war design and construction at pre-war uninflated price is the secret of overwhelming demand for "VOMAX", the true v.t.v.m. Unequaled at any price, it is bought and used by the Bureau of Standards, Navy, P.C.C., C.A.A., schools, universities, research laboratories—and by thousands of experience-wise service technicians. You, too, will find "VOMAX" your greatest profit meter. Only \$59.85 at your favorite jobber.

Measure every type and kind of voltage in receiver design and servicing. "VOMAX" increases your efficiency and profits by equipping you to measure r.f., i.f., a.f.—actual signal volts—a.v.c., a.f.c., discriminator—a.c. and d.c. volts. Input resistance is so astronomically high you can measure directly even in the highest resistance circuits. "VOMAX" is also your output db. meter; measures direct current up thru 12 Amp. auto set range; resistance up to 2,000 megohms.

Send postcard for new catalog of measuring instruments, communication receivers, transmitters, kits and parts. See them at your favorite jobber.

OVER 35 YEARS OF RADIO ENGINEERING ACHIEVEMENT

McMurdo Silver Co., Inc.  
1240 MAIN ST., HARTFORD 3, CONNECTICUT

## TECHNOTES

### ... HUDSON MODEL SA-39

Weak and erratic reception, particularly at each end of the dial, often can be traced to the 9,500-ohm resistor in the cathode lead of the 6J7-G oscillator mixer. The resistance of this component often increases to the point where local oscillations are weak or cease altogether. Replace this resistor with one of 10,000 ohms.

WILLIAM H. EVANS,  
Alexandria, Va.

### ... COUPLING CONDENSERS

Whenever leaky or shorted coupling condensers are found preceding a power amplifier, the tube should be replaced at the same time as the condenser. The positive voltage placed on the grid by the defective condenser makes the tube draw excess current which often causes it to go gassy. Under these conditions, distortion will still continue after the condenser has been replaced.

HENRY M. HOFFART,  
Shelton, Conn.

### ... INTERMITTENT NOISE

Intermittent noises that develop when a set is tapped or jarred can often be traced to a pilot lamp making poor contact in its socket. This condition may exist even when the lamp does not flicker. A sure cure is to build up the center contact in the socket with solder so that the lamp will fit tighter.

JOHN MEDNANSKY,  
Belle Fourche, S. Dak.



## ANTENNA PRINCIPLES

(Continued from page 33)

that which warned its GI attendant of the oncoming Japanese attack on Pearl Harbor. It is also similar to the array used in 1946 to contact the moon by radar.

### Irregular Patterns

To properly serve two or more populated centers and to avoid possible interference with nearby transmitters, it is often necessary to design a broadcast antenna so that it radiates an irregular

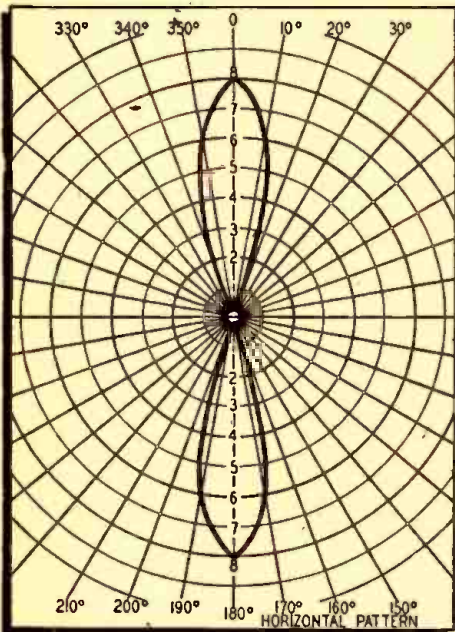
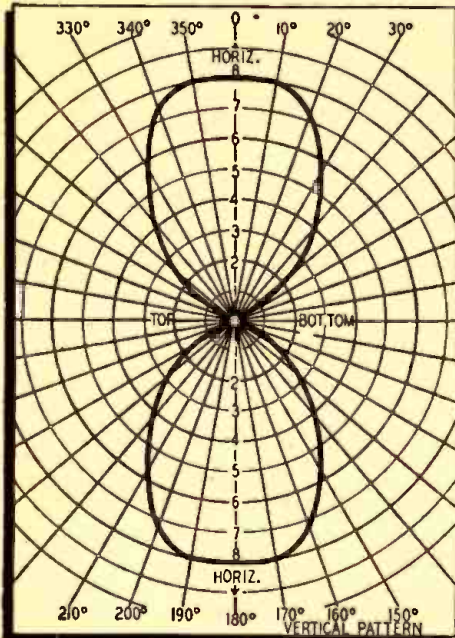

Figs. 2-a and 2-b. Patterns of Fig. 1 antenna. Hold page on side to better understand 2-b.

field pattern (Fig. 3). This also makes it possible to reduce power which otherwise might be wasted on mountains, lakes, and wooded sections. An irregular field pattern requires the use of more than one antenna tower. The pattern can be varied by adjusting the

# Prepare NOW for a Better Job in RADIO ENGINEERING



Don't Delay—  
Write Today!

## ADD TECHNICAL TRAINING TO YOUR PRACTICAL EXPERIENCE.

CLEVELAND INSTITUTE COURSES OFFER COMPLETE TECHNICAL TRAINING RANGING FROM LOW-LEVEL TO COLLEGE-LEVEL.

- A. Master Course in Radio Communication. Covers fundamentals of Radio and includes complete preparation for FCC Commercial License Examinations.
- B. Advanced Course in Radio Communication Engineering. A college-level Radio Engineering Course.
- C. Specialized Television Engineering. Including post-war Television Techniques.

### All Courses Include

The Remarkable Workbooks of Instructional Aids, prepared by the instructing staff of Cleveland Institute.

Choose the course best suited to your needs—Start with the section you are qualified to enter—Use the economical CIRE "Pay-As-You-Go Plan."

You may enroll for individual sections for highly specialized training. Study any one or more of the following sections if you do not require a complete course—

- 1. Mathematics of Radio
- 2. Fundamentals of DC and AC Theory.
- 3. Essentials of Radio Communication.
- 4. Communication Networks.
- 5. Advanced Radio Telephony for the Broadcast Operator.
- 6. Audio and Radio Components and Systems (Design of Receiver and Transmitter Equipment).

Write for descriptive folder • No obligation

## CLEVELAND INSTITUTE OF RADIO ELECTRONICS

CONTRACTORS TO THE CANADIAN BROADCASTING CORPORATION  
Successors to

NILSON RADIO SCHOOL  
Founded 1939

SMITH PRACTICAL RADIO INSTITUTE  
Founded 1934

RC-2 TERMINAL TOWER, CLEVELAND 13, OHIO

Approved for Veteran Training Under "G-I Bill of Rights"

### (MAIL THIS COUPON)

Cleveland Institute of Radio Electronics, RC-2, Terminal Tower, Cleveland 13, Ohio.  
Gentlemen: Please send information about your home study courses in Radio Electronics.

NAME .....  
ADDRESS .....  
CITY .....  
ZONE ..... STATE .....

I desire training in .....  
I have had experience in broadcasting  servicing   
operating  mfg.  CAA  Army-Navy   
amateur  other ..... I am a  
High School Grad.  College  Degree .....  
 Check here for Veteran Enrollment Information.

magnitude and phase of each tower current and the position of each tower.

Because of the many variables concerned, direct mathematical calculations become quite involved and consume a great deal of time. Several instruments are available for easing the problem, however. At least one mechanical device\* has been designed for antenna calculations.

A still more modern and convenient instrument is the RCA Antennalyzer†. An oscilloscope is used to give instantly the field pattern which results from the use of up to five antenna towers. Sixteen dials control the Antennalyzer, four for each tower. Since one tower

is taken as the reference, it requires no control. The four dials represent: magnitude and phase of the tower current; distance and angle (in azimuth) of the tower, with respect to the reference tower. To operate this instrument, the desired pattern is drawn with chalk on the face of the oscilloscope tube. Then the dials are manipulated until the same pattern is traced by the electron beam. The necessary tower factors are taken from the dials.

### Nondirectional Radiation

Many large and small manufacturers are doing research in the design of high-frequency broadcast antenna systems because of the widespread and

(Continued on page 60)

\* RADIO-CRAFT, August 1943, p.652.

† RADIO-CRAFT, May, 1946, p.536.



# METROPOLITAN

Guarantees Delivery From Stock!

## THE NEW MODEL B-45

### SIGNAL GENERATOR

Battery Operated

Self-modulated Signal Generator, providing a highly stable signal. Generates R.F. frequencies from 150 Kc to 12.5 Mc on Fundamentals and from 11 Mc to 50 Mc on Harmonics. R.F. is obtainable separately or modulated by the Audio Frequency. Complete with leads, batteries and instructions.



\$27.75

### New Model 670

### SUPERIOR SUPER-METER

A Combination Volt-Ohm milliammeter plus capacity reactance inductance and decibel measurements

NET ..... \$28.40



### New Model 450

### SUPERIOR TUBE TESTER

"Speedy Operation" assured by newly designed rotary selector switch which replaces the usual snap toggle or lever action switches.

NET ..... \$39.50



## CA-12 SIGNAL TRACER

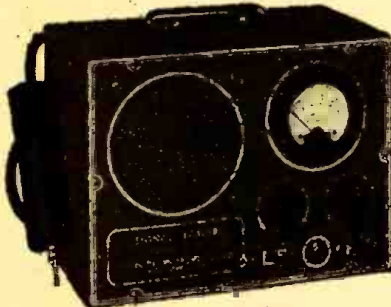

Now you can SEE and HEAR the signal. Simplest operation. Only one connecting cable—NO TUNING CONTROLS! Highly sensitive due to advanced Vacuum-Tube-Voltmeter circuit. Tube and resistor capacity network are built into the Detector Probe. Complete with probe, leads, batteries and instructions.

\$34.85

McMurdo Silver 905 "Spark" Signal Tracer...	\$39.90
McMurdo Silver 904 Capacit. Resist. Bridge...	49.90
McMurdo Silver "Vomax" .....	59.85
SUPREME 543 Multi-Tester .....	18.95
SUPREME 589 Roll-Chart Tube Tester .....	48.95
SUPREME 599 Roll-Chart Tube and Set Tester .....	62.50
SUPREME 565 Vacuum-Tube-Voltmeter .....	63.50
SUPREME 576 Signal Generator .....	68.95
DuMont 5" Oscilloscope .....	99.50

Write for FREE New 1947 Catalog

## METROPOLITAN ELECTRONIC & INSTRUMENT CO.

6 MURRAY ST., Dept. C1, NEW YORK 7, N.Y.

## TELEGUIDED MISSILES

(Continued from page 24)

Electronics is also playing an ever-increasing part in both jet-propelled and glide missiles.

February, 1943, saw the first practical test of glide bombs (an ordinary bomb fitted with wing surfaces) against a target in warfare; 58 B-17's launched 116 GB-1 glide bombs over Cologne,

Colonel Harvey T. Alness and his 7th Bomb Group used this bomb during the spring of 1945 to knock out the Japanese supply railroad running between Burma and Siam.

Another electronic missile, designated *Felix*, had a heat-sensitive electronic unit located in its nose, which by elec-

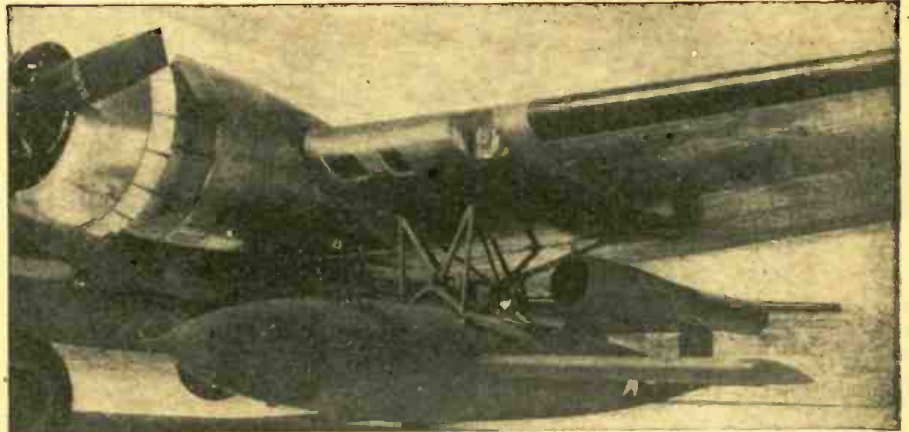

The JB-2 "buzz-bomb" under the wing can be radio-controlled for a flight of 150 miles.

Germany. They were released several miles from the target and guided to their destination by radio impulses sent out from the releasing planes. The glide bombs were thus directed to the target without the necessity of the bombers getting into the danger zone of anti-aircraft fire.

Improvements constantly were made in radio-controlled glide bombs. Drop bombs were fitted also with a special tail assembly that contained a built-in radio unit which through servo units could control the angle of free fall of these bombs by varying the slipstream over the rudder surfaces. This free-falling bomb was called the *Azon* bomb, indicating it was controllable in azimuth only.

trical impulses operating on the tail surfaces guided the missile in its free fall to a target that was emitting heat—such as a steel mill or a blast furnace.

The *Razon* bomb, an improvement over the *Azon*, was controllable by electrical impulses both in azimuth and range. It had a gyro stabilizer which kept it from turning in the air during the period of fall. The tail unit had four elevators or rudders which permitted this double control.

One of the latest developments in free-falling missiles, the standard 1,000-pound bomb known as *Roc* is fitted with a television scanner in its nose. The ground area that the bomb scans during its free fall is televised back to the bomb-releasing plane, thereby en-



The Roc televises a view of the target back to its control, who guides it accordingly.



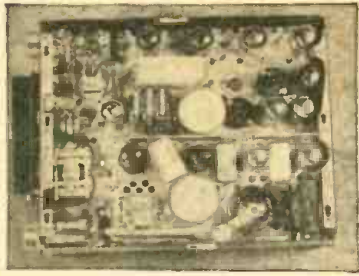

**General Electric RT-1248 15-Tube Transmitter-Receiver**  
**TERRIFIC POWER (20 Watts)** on any 2 instantly selected, easily pre-adjusted frequencies from 435 to 500 Megacycles. Transmitter uses 5 tubes including Western Electric 316 A as final. Receiver uses 10 tubes including 6X5's as first detector and oscillator, and 3-7H7's as IF's, with 4 side-tuned 40 MC. IF transformers, plus a 7B7, 7E3's, and 7F7's. In addition unit contains 3 relays designed to operate any sort of external equipment when actuated by a received signal from a similar set elsewhere. Originally designed for 12V operation, power supply is not included, as it is 2 inches for any amateur to connect this unit for 110V AC, using any supply capable of 400V DC at 135 MA. The ideal unit for telephone use as in a taxicab, or for any kind of remote control applications as with drone airplanes. Instructions and diagrams supplied for running the RT-1248 transmitter on either code or voice, and for using the receiver as either an AM or FM set. As an FM set, the receiver section of the 1248 is capable of better results than almost any of the commercial FM sets on the market, largely as a result of the superb engineering and meticulous workmanship employed in constructing the converter, oscillator and IF sections. Supplied in original cartons with 15 tubes. Your cost \$29.95—10% less if ordered in lots of 2 or more. If desired for marine or mobile use, the dynamotor, which will work on either 12 or 24 VDC and supply all power for the set, is only \$15.00 additional.

## Famous Collins Autotune Transmitter

This is the well known unit used in Army and Navy planes that features automatic motor tuning of any of 11 front-panel preselected frequencies up to 18,100 Kc, as well as manual tuning at any time. The transmitter operates on voice, CW, and MCW on all frequencies. This beautifully designed unit uses an 813 final, and push-pull 811's as modulator, measures 23 1/2 x 13 1/4 x 11, and weighs 70 lbs. Estimated average power output is 150 Watts. Price including dynamotor—\$185.00. Write for literature describing any units you wish more information on.

### BENDIX SCR-522

Very High Frequency Voice Transmitter-Receiver—100-to-166 MC. **THIS JOB WAS GOOD ENOUGH FOR THE JOINT COMMAND TO MAKE IT STANDARD EQUIPMENT IN EVERYTHING THAT FLEW EVEN THOUGH EACH SET COST THE GOV'T. \$2500.00.** Crystal Controlled and Amplitude Modulated—High Transmitter Output and 3 Microvolt Receiver Sensitivity gave good communication up to 180 miles at high altitudes. Receiver has 10 tubes and transmitter 7 tubes, including 2-832's. Furnished complete with 17 tubes AND POWER SUPPLY for 12 or 24 volts, also remote control boxes and cable connectors. We include complete diagrams and instructions for the simple conversion of the 522 to full 110-Volt, 60-Cycle operation. Your cost \$44.50

### Six Band Communications Receiver

Featuring continuous coverage from 1500 Kc. to 18,000 Kc on a direct reading dial with the finest vernier drive to be found on any radio at any price—extreme sensitivity with a high degree of stability—crystal filter and phasing control—BFO—antenna compensation—transmit-receive relay—standard 6 volt tubes. Contains a plate supply dynamotor in compartment within the handsome black crackle finish cabinet, the removal of which leaves plenty of room for installation of a 110V, 60 or 25-cycle supply. These new receivers, which make any civilian communications receiver priced under \$200.00 look cheap and shabby by comparison, are only \$44.50. Power supply kit for conversion to 110V, 60 Cycle, is only \$3.50 additional.

### CHECK THESE BARGAINS

**WIRELESS RECORD CHANGERS**—These are beauties—two post, with featherweight plastic and chrome pick-up, plays 10" and 12" records intermixed through any radio without connections. Complete with your choice of blue leatherette or walnut stained cabinet, priced at only \$28.95.

**D.C. POWER SUPPLIES**—Operates from 110 V 60 Cycle, features perfect filtering for smoother output. Output 6 Volts—20 Amps.; 12 Volts—10 Amps. Either 6 or 12 volts may be used at the same time. Made by one of America's foremost manufacturers. Priced at \$36.95.

**PUBLIC ADDRESS AMPLIFIERS**—25 Watts peak output, complete with 5 tubes, separate controls for Microphone and Phono Inputs, \$65.00 value for only \$32.00.

### GENERAL ELECTRIC 150-WATT TRANSMITTERS ... NOW ONLY \$44.50

These units manufactured for the Army Air Forces during the war by General Electric are now available at a price every amateur can afford. They are the same brand new transmitter, complete with seven plug-in tuning units, antenna tuning unit, dynamotor, connector plugs, cables, all tubes, and instruction book, which sold for as high as \$175.00 last year. These transmitters have a frequency range of 200-500 Kc. and 1600-12,500 Kc. and will operate on the 10 and 20-meter bands with slight modification. Instruction booklet for conversion to 110V, 60-Cycle is also included. Transmitter dimensions are 21 1/2 x 23 x 9 1/2 inches. Total shipping weight 250 lbs. Obtain yours NOW for the lowest price at which this model has ever been sold **COMPLETE** ..... \$44.50

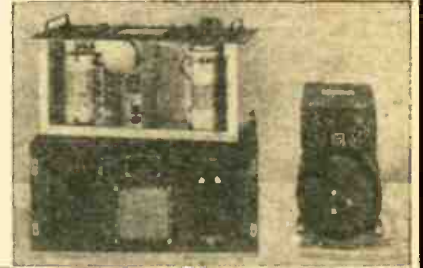
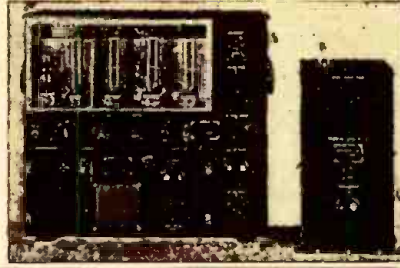

**BUFFALO RADIO SUPPLY • 219-221 Genesee St., Dept. 2C • Buffalo 3, N. Y.**

abling the bombardier to guide Roc to its target by means of radio impulses. Differing from all other free-falling missiles, Roc utilizes a circular airfoil which can be tipped at different angles by radio impulses, thus changing the angle of fall.

In the field of radio-controlled jet-propelled missiles is the German V-2 rocket, which was used largely in the latter months of World War II in Europe for attacks on England, Belgium, and Holland. This missile has a complicated electronic control: there are radio-controlled carbon deflectors at the mouth of the rocket engine which control the blast angle during take-off and acceleration, and rudders located at the end of the four stabilizing vanes guide the rocket after the jet motor has ceased to function, which is 63 seconds after ignition.

There is no field of either free-falling drop missiles or jet-propelled missiles in which electronics does not play an ever-increasing and important part, and undoubtedly this will continue to hold in the future. Recently charged with the responsibility for all War Department investigation of guided missiles, the AAF is subjecting new developments in this field to exhaustive evaluation.

(It is interesting to note that a completely remote-controlled plane incorporating television was proposed by Hugo Gernsback more than twenty years ago in his magazine, *The Experimenter*, November, 1924. The illustration reproduced with this article is from

that issue. Camera tubes were to be pointed in the six cardinal directions, each transmitting the view it picked up to the control headquarters, where all the images were to be projected on a single screen, giving the commanding officer a complete view of the whole scene of action. Television reconnaissance planes were actually used to some extent in the Pacific theater, and a demonstration of *Block and Ring* airborne reconnaissance television was given at Washington last year. [RADIO-CRAFT, May, 1946]. Television was also used on the Roc, to transmit the scene ahead of it and thus permit the control operator to guide it accurately to its target.—Editor)

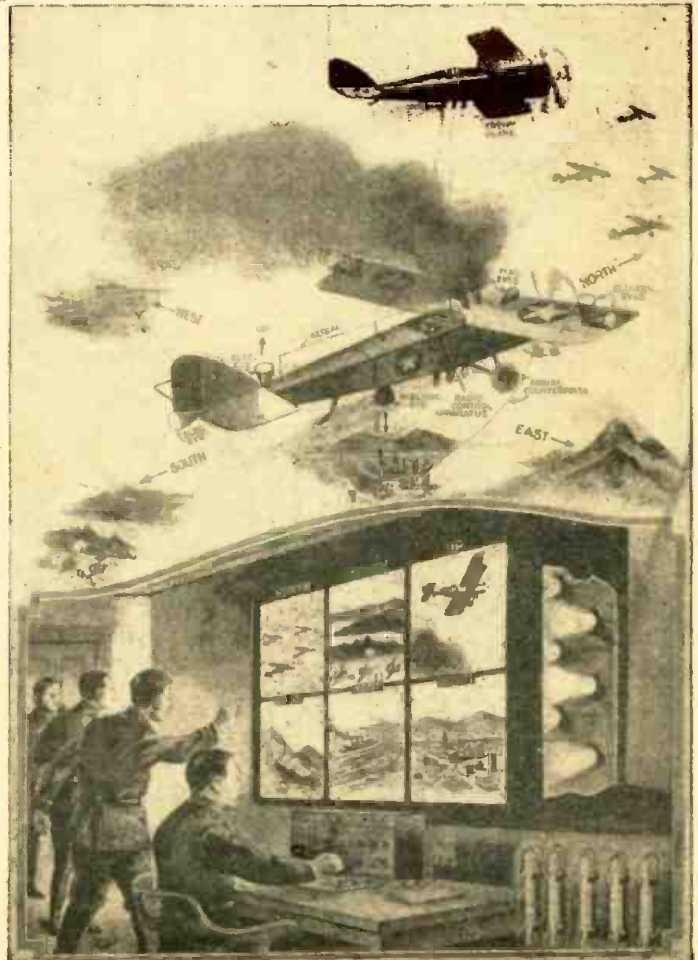

Reproduction of the page which showed the proposed television plane.



JUST OUT!



FOR BETTER SERVICE

**AUDELS OIL BURNER GUIDE**—A new practical, concise treatise, 384 pages—31 Chapters—321 Diagrams and Illustrations—covering Domestic and Industrial Oil Burners. New from Cover to Cover. Gives practical inside working knowledge of the theory, construction, installation, operation, testing, servicing and repair of all types of oil burners. Includes electrical hook-ups and wiring diagrams of automatic control systems. Step up your own skill with the facts and figures of your trade. Audels Mechanics Guides contain Practical Inside Trade Information in a handy form. Fully Illustrated and Easy to Understand. Highly Endorsed. Check the book you want for 7 days Free Examination. Send No Money. Nothing to pay postman.

**CUT HERE MAIL ORDER**

**AUDELS, Publishers, 49 W. 23 St., NEW YORK 10, N. Y.**  
Please send me postpaid for FREE EXAMINATION books marked (x) below. If I decide to keep them I agree to mail \$1 in 7 days on each book ordered and further mail \$1 monthly on each book until I have paid price. Otherwise, I will return them.

- OIL BURNER GUIDE, 384 Pages . . . . . \$1.
- REFRIGERATION & Air Conditioning, 1280 Pgs. 4.
- POWER PLANT ENGINEERS Guide, 1500 Pages. 4.
- PUMPS, Hydraulics & Air Compressors, 1658 Pgs. 4.
- WELDERS GUIDE, 400 Pages . . . . . 1.
- BLUE PRINT READING, 416 Pages . . . . . 2.
- SHEET METAL WORKERS Handy Book, 388 Pgs. 1.
- SHEET METAL PATTERN LAYOUTS, 1100 Pgs. 4.
- AIRCRAFT WORKER, 240 Pages . . . . . 1.
- MATHEMATICS & CALCULATIONS, 700 Pgs. 2.
- MACHINISTS Handy Book, 1600 Pages . . . . . 4.
- MECHANICAL Dictionary, 968 Pages . . . . . 4.
- AUTOMOBILE GUIDE, 1540 Pages . . . . . 4.
- DIESEL ENGINE MANUAL, 400 Pages . . . . . 2.
- MARINE ENGINEERS Handy Book, 1280 Pages 4.
- SHIPFITTERS Handy Book, 272 Pages . . . . . 1.
- MECHANICAL DRAWING COURSE, 160 Pages 1.
- MECHANICAL DRAWING & DESIGN, 480 Pgs. 2.
- MILLWRIGHTS & Mechanics Guide, 1200 Pgs. 4.
- CARPENTERS & Builders Guides (4 vols.) . . . 6.
- PLUMBERS & Steamfitters Guides (4 vols.) . . 6.
- MASONS & Builders Guides (4 vols.) . . . . . 6.
- MASTER PAINTER & DECORATOR, 320 Pgs. 2.
- GARDENERS & GROWERS GUIDES (4 vols.) 6.
- ENGINEERS and Mechanics Guides . . . . . 12.
- Nos. 1, 2, 3, 4, 5, 6, 7 and 8 complete . . . 1.
- Answers on Practical ENGINEERING . . . . . 1.
- ENGINEERS & FIREMANS EXAMINATIONS . . . 1.
- ELECTRICIANS EXAMINATIONS, 250 Pages . . . 1.
- WIRING DIAGRAMS, 210 Pages . . . . . 1.
- ELECTRICAL DICTIONARY, 9000 Terms . . . . . 2.
- ELECTRICAL POWER CALCULATIONS, 425 Pgs. 2.
- HANDY BOOK OF ELECTRICITY, 1340 Pages . . . 4.
- RADIOMANS GUIDE, 914 Pages . . . . . 4.
- ELECTRONIC DEVICES, 216 Pages . . . . . 2.
- ELECTRIC LIBRARY, 12 vol., 7000 Pgs., \$1.50 vol.

Name \_\_\_\_\_  
Address \_\_\_\_\_  
Occupation \_\_\_\_\_  
Employed by \_\_\_\_\_

R.C.F.

## SIMPLE MODULATION METER

(Continued from page 32)

The observed pattern is very simple to interpret. There are no set of patterns to memorize. With no r.f. signal there will be a single horizontal line. With the carrier turned on, *sans* modulation, a horizontal rectangle of light will appear on the cathode-ray tube. This corresponds to pattern A in Fig. 2. Regardless of the horizontal sweep frequency selected it will be found impossible to see the individual alternating waves of the carrier because their frequency exceeds the available sweep frequency by a large amount.

With sinusoidal modulation and correct operation of the modulated stage, pattern B in Fig. 2 will be observed. Here the horizontal sweep frequency selector and fine control should be adjusted to observe the audio waveform upon the carrier, the same as if observing straightforward audio from an amplifier. With voice modulation clear curves will not be seen, but the peaks and minima may be observed for approximate modulation percentage. It is possible to whistle into the microphone and hold a pure sine-wave audio pattern long enough for close measurements, when it is desired to check the overall audio gain and modulation characteristics.

Percentage of modulation is found by

$$\text{the formula } M = \left( \frac{2P}{Q - N} \times 100 \right)$$

P is the unmodulated height of carrier signal as viewed on the scope tube. Q is one-half the peak-to-peak vertical signal produced by modulation. N is one-half of the node-to-node signal produced by modulation. These figures are clearly shown on pattern B in Fig. 2.

As the formula indicates, 100 percent modulation occurs when the minima or nodes come in to just touch each other, while the peak-to-peak signals swell out to twice the unmodulated value. At 50 percent modulation these peaks and minima increase and decrease the unmodulated carrier waveform by that percentage. Thus by adjusting the sweep rate to make the audio waveform visible, it is possible to approximate the percentage of modulation at a glance.

Unsymmetrical modulation is indicated by any difference in the percentage of increase of the peak-to-peak signal versus the node-to-node signal. Simply stated, if the negative audio cycle reduces the carrier pattern by one inch and the positive alternation increases it by only three-quarters of an inch unsymmetrical modulation exists. In this case, with more negative signal than positive, there would be a *downward shift* of average carrier power under modulation. Incorrect bias in the speech amplifier or modulator, poorly regulated plate supply to the final, or incorrect r.f. excitation of the final could cause these symptoms. Excitation could be excessive in the case of fixed bias, insufficient in the case of grid-leak bias.

Failure to bypass the cathode bias resistor in the final for the audio as well as the r.f. component may produce this undesirable result. Where unsymmetrical modulation causes an upward shift of average carrier power, it can usually be attributed to improper operation of the audio system or incorrect r.f. excitation. With suppressor-grid or grid-bias modulation, these symptoms may indicate incorrect biasing of the modulating grid, or poor stability of the r.f. exciting source to the final stage.

Pattern C in Fig. 2 indicates down-

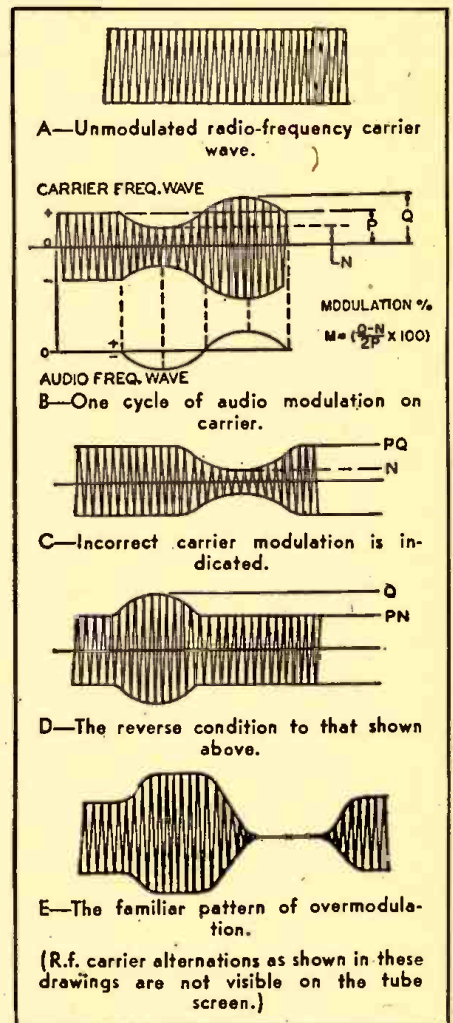

ward modulation only. This can indicate failure of one of the tubes in a push-push class-B modulator stage, single-ended class-B modulation, incorrect bias of a class-A modulator, or incorrect operation of the final modulated r.f. stage. Incorrect biasing of the modulated grid in either suppressor-grid or grid-bias service may produce this result. Where the final r.f. tube is operated with an incorrect plate current load, saturation may prevent a rise of plate current and only the negative modulation cycle which reduces this plate current may be visible. This can



be due to wrong r.f. excitation or load.

Single-ended class-B or failure of one of the tubes in a class-B push-push modulator may cause pattern D of Fig. 2 to appear on the 'scope. This last statement may sound confusing as we just mentioned that these same items could cause downward modulation. The answer lies in the phasing of the signal from the modulator. With single-ended class-B, only one-half cycle is produced in the output winding of the modulator. Therefore the voltage produced makes one output lead positive and one negative *all the time* with no alternation in polarity. These leads may be connected to give either upward or downward modulation. Each tube in a double-ended Class B modulator produces a half cycle in opposite directions to form an alternating cycle or sinusoidal modulation. Depending upon which tube fails, the modulation may be upward or downward. Incorrect bias in a class-A modulator, improper r.f. excitation, or incorrect plate current in the final stage (too low for modulator output so that negative audio peaks are clipped) may cause this pattern to appear.

Symmetrical overmodulation is indicated by pattern E of Fig. 2. Here excessive modulation may be indicated by a flattening of the peaks and nodes of the carrier signal. Unsymmetrical overmodulation will flatten either the peaks or nodes, first one and then the other as overmodulation is increased.

Summarizing, this system has two advantages and one disadvantage when compared to the trapezoidal method of modulation checking. The disadvantage is that unlike the trapezoidal method of indicating modulation, a sweep control must be set to a frequency which matches approximately the predominate voice or oscillator audio frequency. However in both cases an unvarying note must be used if the patterns are to be observed with any degree of accuracy. The advantages override any disadvantages. There is no need to open up a transmitter to secure any leads, making field checks (as in aircraft) easy. The resultant patterns are few and easy to interpret without memorizing. The simplicity of the system and its use of standard available equipment is another good point.

## SOUND ENGINEERING

(Continued from page 36)

Patent No. 1,990,024, which is available at 25 cents, from the U. S. Patent Office, Washington, D. C.

## DISTORTION ELIMINATION

### The Question:

I am using a 17-watt amplifier and plug my electric guitar into it to use as the amplifier for the instrument. Either the amplifier or the speaker distorts or rattles on bass notes. I have tried several kinds of speakers (PM) with good wattage ratings but the distortion still occurs on high volume.

Could you please tell me how to eliminate this trouble? I have built many

types of amplifiers and have tried different pickups of the same type and they all distort.

I am using a type of pickup with strings vibrating in the magnetic field.

EDWIN COOPER,  
Independence, Kansas

### The Answer:

The trouble you are experiencing may be caused by any one of the following:

1. Overload at low frequencies.
2. Improper mounting of magnetic pickup.
3. Mechanical rattles caused by loose hardware, speaker cone hitting cabinet, or acoustical resonance at some low frequency.

It will be necessary to determine which of these are causing most of the trouble. I therefore suggest that you have the amplifier checked for its power-handling capacity at low frequencies. Distortion at low frequencies can be approximated by using a reasonably good audio-frequency oscillator and oscilloscope. Watch the wave form at low frequencies when the amplifier is properly loaded. If the strings are not vibrating in a homogeneous magnetic field, distortion will be apparent, particularly at the low frequencies.

To check for mechanical rattle, an oscillator should be connected into the amplifier and its frequency slowly changed throughout the audio spectrum. Any rattle will be easily detected. Once the causes are found, corrective measures will suggest themselves to you.

Radar tracking of "rocketsondes" will enable the U. S. Navy to study weather at heights from 100,000 to 500,000 feet, thereby securing data of great value to aviation, according to Lt. Commander Daniel F. Rex, of the Navy's Office of Research and Invention.

**150 DIAGRAMS**  
**150 DIAGRAM BOOK** **FREE**

For Examining My  
New 7 Volume Set on  
**ELECTRICITY**

HERE'S a valuable book of 150 Electrical and Radio wiring diagrams with charts and instructions. Practical information you need to win security and promotion. It's yours FREE merely for examining my 7-Volume Set on Applied Practical Electricity on 7-day's free trial. This 7-Volume Set COVERS EVERYTHING ELECTRICAL FROM HOUSE WIRING TO ADVANCED AC-DC MOTORS and EQUIPMENT. Thousands of diagrams and photos... written so both "beginners" and "old-timers" can easily understand.

**7-DAY'S FREE TRIAL** I want to send you the 7-volume set AT MY RISK, postpaid, for 7-day's FREE examination. I'll also send you the FREE book of 150 Shop Prints which you are to keep as my gift regardless of whether or not you return the 7-books set. (Nosalesman will call.)

**Offer Limited—Send Coupon Now!**

**FREE COUPON** NOT AN ORDER—JUST A REQUEST TO SEE BOOKS

H. C. Lewis, Pres., Coyne Electrical School, Dept. 27-T2  
500 S. PAULINA STREET, CHICAGO 12, ILLINOIS

Send me the new 7-volume set "Practical Electricity." Also send the book of 150 Shop Prints which is a FREE gift to me regardless of whether or not I keep the 7-volume set. I'll either return the 7-book set in 7 days and keep the 150 Shop Prints book as a gift from you and owe you nothing, or pay \$3 within 7 days and \$3 a month until \$24 is paid, or I'll send the cash price of \$19.75. One year FREE Consultation Service and Technical Bulletins included.

NAME \_\_\_\_\_ Age \_\_\_\_\_  
ADDRESS \_\_\_\_\_  
TOWN \_\_\_\_\_ Zone \_\_\_\_\_ STATE \_\_\_\_\_  
 Check here if you want to save \$1.25 by paying the postman the cash price of \$19.75 on delivery. Same 7-day's examination and Money-Back Guarantee.

## SERVICE-MEN'S SPECIALS

- SMALL MOTORS:** G.E. 27V. DC. 145 RPM. .65 amp. 14 oz./in. 1 1/2"x4". Shpg. wt. 1 lb. \$1.49  
Shunt Wound 1/40 H.P. Reversible. 27V DC. 3800 RPM. 1.4 amps. continuous duty. 3"x4 3/4", shaft 7/8" long. Black crackle finish. 3.45  
**POWER RHEOSTATS:** Heavy duty. Popular brands. 25 watt—\$1.30, 175, 277, 500, or 1800 ohms .89  
50 watt—2, 4, 40, 250, 300, 3K, 7500 or 10 K ohms 1.29  
**SPECIAL:** 50 watt 5 ohm rheostat 1.29  
Dual 50 watt 200 ohm rheostat 1.79  
**SHUNTS—MULTIPLIERS:** 1% precision, wire-wound. Ohmages: 2.5, 11, 24.5, 408, 840, 1740, 2500, 3300, 3330, 5200, 7800, 30K, 50K or 400K .35  
Binding Posts (TM175) Hvy duty plated brass. Need no contact, knurled head. O.D. 1/4", 3/4", high. 12 for 1.00

## ALNICO MAGNETS

- |  |  |       |
|--|--|-------|
|  | #1—Bar, 3/4"x1/4"x1/8"                           | \$.39 |
|  | #2—Bar in shorter lengths, per inch              | .12   |
|  | #3—Face 1/2"x1/2"x3/8" high                      | .98   |
|  | #4—Heavy duty bar 3/4"x1/2"x5/16" thick          | .98   |
|  | #5—Face 3/4"x3/8"x3/8" high                      | .39   |
|  | #6—Polished face 7/8"x9/16"x3/8" high            | .35   |
|  | #7—Polished bar 9/16"x3/4"x1/8" 20 for           | 1.00  |
|  | #8—Face 1/2"x1/2"x3/8" high                      | 1.00  |
|  | #9—ALNICO V.h.shoe, poles 3/8" sq. 1 1/2" high   | .75   |
|  | #10—ALNICO V.h.shoe, poles 9/16" sq. 1 1/2" high | .98   |
|  | #11—ALNICO V.h.shoe, poles 1"x1 1/2"x2 1/4" high | .95   |
|  | #12—Horseshoe, ea pole 1 1/16" O.D. 2 1/4" high  | 1.29  |
|  | #13—(Similar to #5) 3/4"x3/8"x7/16" high         | .35   |

**SPECIAL SIZES IN QUANTITY. CUT TO ORDER**  
TUBES: Perfect condition, but not in sealed cartons. Guaranteed for 90 days. \$26, 27, or \$6—29¢; \$24, \$27, \$29, \$39, \$49, \$68, \$88, or \$K7—39¢; \$50, \$75, \$78, or \$A3—\$.59.

- Brand new R.C.A. UX-200 tubes in sealed cartons. Ideal detector—\$3 for \$1.00.  
**HEADPHONES:** Sigsbee Corp. HS-33 2000 ohms. Leather covered, adj. forks. With PL-54 plug—\$1.25. With sponge rubber phone cushions—\$1.45.  
Headsets only (as above), with PL-54 & cord—\$2.19  
PL-54 plug and 13' tipped double wire cord—\$.19  
**SELSYN SYNCHRO-TRANSMITTERS** 115V, 60 cycle. Brand new, in original cans. Used in pairs as transmitter and receiver. 1/2"x5"—per pair \$10.49  
**4 TUBE AMPLIFIER** (2-7C5, 777, 774) used as electronic supercharger control. 110V, 400 cycle. Contains: power trans, 7 condensers (mica and oil), 7 resistors, 4 socket sockets plus other components worth several times the price. Black crackle finish; fitted slide-in chassis. 8 3/4"x4 1/2"x3 3/4". Less tubes—\$1.49  
Frequency meter Tech. Manual (Navy) Theory & Operation. 39 illustration & diagrams: 58pp. \$5.15  
**EXPERIMENTAL TUBES.** An assortment of 20, filament tested, including most sizes & base types. 1.00  
**RADIO TELEPHONE HANDSETS** (Arctic 1-13) Contains sensitive 200 ohm mike & 1000 ohm phone. push-to-talk switch. 9 1/2" french type unit. Complete with 1 1/2" ft. cord, PL-55 and PL-68 plugs. \$2.95  
**RADIOMAN'S HARDWARE** (Electric) Over 1000 nuts, screws, lugs, washers, etc. PLUS handy 96 compartment cardboard kit box. \$5.59  
16 N.B.C. RECORDINGS. Each contains 2 complete 15 min. pieces of the Army's dramatic programs with music. Over 60 different titles, such as: Whistling Willie, Case History, Philippine Return, etc. 1 1/2" P.M. 5 ast recs. \$1.49  
32mf/450W tubular electrolytics. 2 1/2"x4" \$1.00  
20mf/200W tubular electrolytics. 6 for \$1.00  
5 TUBE AMPLIFIER (Bendix). 2-6N6, 3-6SN7. Orig. used with remote indicator. 27V, DC-110V, 400 cycle. Black crackle, shock-mtd. case & fitted chassis. 7 3/4"x5 1/2"x4 1/2". Shpg. wt. 7 lbs. Less tubes. \$2.49  
Ceramic Coil Forms. Low loss ribbed & grooved, lead-in & mtg. holes. 3/16" wall. O.D. 2"x5". \$1.45  
Victor Power Transformer for models R-32, 45, 52 or 75. Unshilded. \$3.95  
BAKELITE PANELS: 1/2" glossy brown. 7"x10" \$5.59  
110V PANEL LIGHT ASSEMBLY. 1" amber jewel. D.C. bay base. Gun metal finish; O.D. 1" \$4.49  
Neon Glow Lamps (fits above assembly) 110V. 1/4 watt. clear bulb. Double cont. bay base. \$2.29  
Motor Case & Housing (round). Complete with glass & adjust screw. 1" deep \$3.39

## SERVICEMEN'S KITS

- |  |      |
|--|------|
| #1—R.F. Antenna & Osc. coils. 10 ass'd.  | .98  |
| #2—Speaker cones: 12 ass'd. 4 to 8" moulded & free-edge (magnetic inc.) Less voice coils | 2.00 |
| #3—BAKELITE MICA CONDENSERS: 50 ass'd. .0005 to .001. 200-600WV. Clearly marked          | 2.95 |
| #4—Tubular By-Pass Condensers: 30 ass'd. .0005 to .25mf. 200-600WV. Standard brands      | 2.49 |
| #5—Electrolytics: 10 ass'd. including multi-section, paper & can types                   | 1.25 |
| #6—Dial Scales: 25 ass'd. airplane & slide-rule (acetate & glass included)               | 2.98 |
| #7—Escutcheon Plates: 25 airplane, slide-rule and full vision types                      | 2.95 |
| #8—Knobs: 25 ass'd. wood & bakelite, including setscrew & push-on types                  | 1.00 |
| #9—Wafer Sockets: 12 ass'd. 4 to 7 prong   | .25  |
| #10—Voltage Dividers: 10 ass'd. standard multi-tapped. High wattages included            | 1.98 |
| #11—Shield Cans: 15 ass'd. for coils, tubes, transformers, etc.                          | 1.00 |
| #12—Misc. Padders & Trimmers: 15 ass'd. incl. multiple & ceramic base types              | .89  |
| #14—Potentiometers & Controls: 10 ass'd. wire-wound & comp. Less switches                | 1.49 |
| #15—Wire-Wound Resistors: 15 ass'd. ohmage 5 to 20 watts                                 | .96  |

PROMPT SERVICE ON ALL SPEAKER & PHONO PICK-UP REPAIRS. Minimum order \$2.00—20% deposit required on all orders.

WRITE DEPT. RC-2  
Please add sufficient postage.



**LEONIE RADIO CO.**  
MAKERS OF CONES AND FIELD COILS  
65-67 DEY STREET, NEW YORK 7, N.Y.  
WORTH 2-0284-5  
12,000 SQ. FT. OF RADIO PARTS



# Low Cost FEILER TS-1

## Signal Tracer

Saves Time & Guesswork  
on All Radio Repair Work

MODEL TS-1  
ONLY  
\$9<sup>85</sup>

Complete with  
vacuum tube  
(less batteries)



### Easy to Use! Pays for Itself!

GETS TO THE HEART OF RADIO  
TROUBLE IN A FLASH!

Locates Causes of:

- Noisy Sets
- Low Sensitivity
- Parts Failure
- Distorted Tone
- Mistracking
- Intermittent Sets

Servicemen! Experimenters! Here's an absolutely dependable Signal Tracing Analyzer at the lowest price ever quoted for such an instrument! Enables you to test any radio or amplifier just by touching the Analyzer probe to any portion of the circuit—the signal you hear in the phones permits you to isolate and locate the trouble in just minutes. Easy to use—no special skill needed. Works with any magnetic headset, 1000 ohms or higher. Requires only one 22½ v. battery and one No. 2 flashlight cell. Self-contained in compact (6¾ x 4¾ x 3¼") brown metal case; with snap-lock cover and battery compartment. Compact bakelite probe houses miniature vacuum tube and circuit components; has 3 ft. cable. With excellent step-by-step instruction repair guide. An invaluable instrument that pays for itself quickly!

IMMEDIATE DELIVERY! Place your order for the TS-1 Signal Tracing Analyzer with your regular parts jobber. If he cannot supply you, write for name of nearest jobber stocking this instrument—or send your order directly to us.



FEILER ENGINEERING CO., Dept. 2-B7  
803 Milwaukee Ave., Chicago 22, Illinois

Ship me one TS-1 Signal Tracing Analyzer

\$..... enclosed.

Send me FREE descriptive literature.

Send name of local jobber stocking TS-1.

Name .....

Address .....

City ..... Zone ..... State .....

## ANTENNA PRINCIPLES

(Continued from page 55)

increasing importance of FM and television.

Requirements for high-frequency broadcasting present very special problems. First there is the consideration of distance coverage (Fig. 4). Because of the line-of-sight limit, large population centers can be properly served only by locating the transmitting antenna in the heart of a city and high enough so that it overlooks most obstructions. FM,

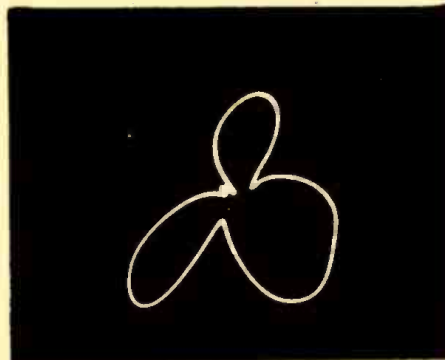

Fig. 3—Field pattern of WMAL, Washington.

television, and multiple communication require very wide modulation-frequency bands, and consequently special antenna designs. As the carrier frequency increases, the length of a resonant conductor becomes smaller, and as the modulation band increases, the cross section must be made greater.

Many high-frequency antenna systems now in operation take on odd shapes and sizes, often named for the objects they resemble (cloverleaf, turnstile, rocket). Each is designed for circular radiation at low angles, a wide modulation band, and small mounting area.

All these commercial antennas are designed according to the fundamental principles already set forth. They have, however, many interesting special features, arising in most cases out of using different methods of solving the same problem. A description of these antennas is worth an article in itself, and the next number in this series will cover a number of them.

### Field Surveys

By mathematical calculations and by the use of precision mechanical computing devices and such instruments as the Antennalyzer, it is possible to de-

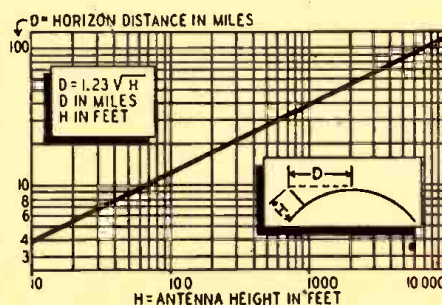
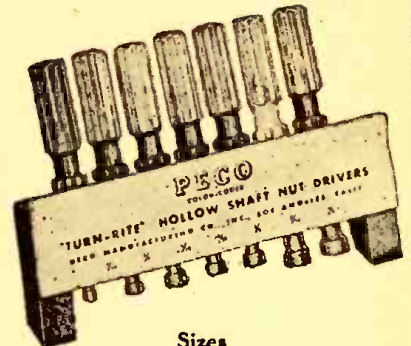

Fig. 4—Antenna height and broadcasting range.



## WHOLESALE RADIO-ELECTRONICS PARTS DISTRIBUTOR

### PLASTIC HANDLE NUT DRIVER KIT



Sizes  
3/16", 1/4", 5/16",  
11/32", 3/8", 7/16", 1/2".  
With handsome tool holder.  
Your cost—\$4.95

### NAVY ANTENNA!

Can be used indoors or outdoors.  
Easily mounted. Your cost—\$1.95

### METER SPECIALS

HALLICRAFTERS — 5 MA — "S" METER .....	\$4.95
WESTINGHOUSE 3½"—0.1 AMP. D.C. METER .....	\$3.95
3½"—0.5 AMP. R.F. METER .....	\$3.95
3½"—0.15 VOLTS A.C.—VOLT-METER .....	\$3.95
G.E.—3½"—0.2 VOLTS A.C.—VOLT-METER .....	\$3.95
WESTERN ELECTRIC—3"—0—200 MICRO-AMP. METER .....	\$4.95

### L PAD

8 Ohms. Safely Rated 3 Watts.  
Has continuous range from 5 to 30 DB. Your cost.....95c each

### 15 WATT UNIVERSAL OUTPUT TRANSFORMER

Uncased. Channel mount ....95c each

MAIL ORDERS FILLED PROMPTLY



509 ARCH STREET  
PHILADELPHIA 6, PA.  
LOmbard 3-0513



termine accurately the field radiated by any antenna. However, the actual field intensity at any point is known only when ideal conditions exist. Especially at the higher frequencies, field strength and contour are determined not only by the radiation characteristics but also by the height of the antenna and the obstructions.

Broadcast stations must supply actual field measurements to the FCC so that possible interference between stations can be eliminated and maximum population coverage provided.

The Federal Communications Commission requires the use of accurate receiving and continuous recording equipment for the survey. Generally the chart may be driven by the same mechanism which actuates the speedometer of the automobile or truck which holds the equipment. Recording is made along eight radials extending from the transmitter, each spaced by about 45 degrees. Highways spaced so conveniently do not generally exist, but it is usually possible to choose streets or roads which run approximately parallel to such radials.

The survey must continue past the points which indicate 1,000 microvolts per meter of field strength so that the required 1,000-microvolt contour may be drawn. A 500-microvolt contour around the station is required also, but due to difficulty with fading at such low field strength it is usually computed from the data for the stronger field. A typical recording is shown in Fig. 5.

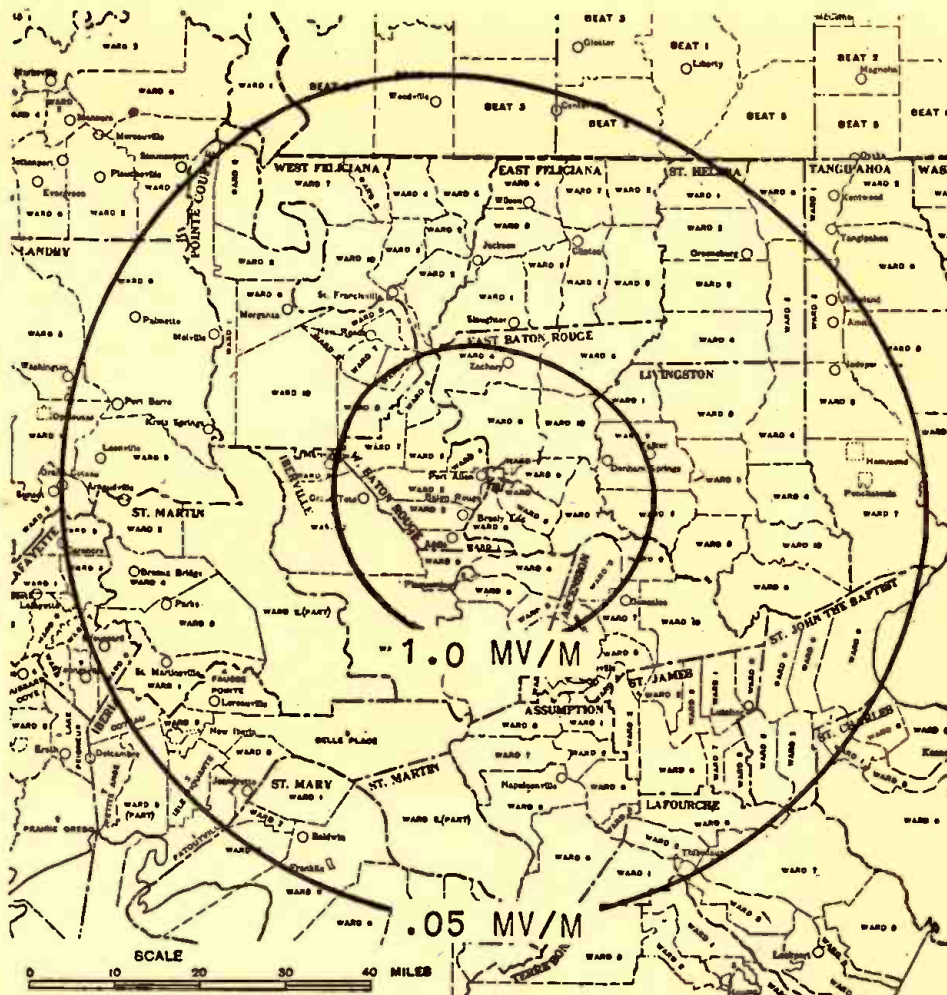

Fig. 5—A typical radio contour map, showing 1,000 and 500 microvolt-per-meter coverage.

# FIX ANY RADIO

## Amazing New Invention



Find radio faults with a new simplified method. Repair all radios in minutes instead of hours. Revolutionary, different *Comparison* technique permits you to do expert work almost immediately. Most repairs can be made without test equipment. Simplified point-to-point, cross-reference, circuit suggestions locate faults quickly and easily.

PRICE ONLY  
**\$1.50**  
COMPLETE

### CHARTS, BLUE-PRINTS, TESTS, PICTURES, HINTS, JOB-SHEETS

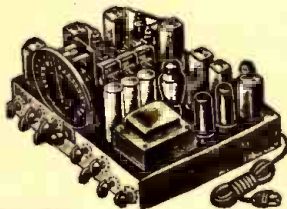

Learn time-saving trouble-shooting short-cuts; find any radio fault with ease. Follow the tests shown on 24 large circuit blue-prints. Over 1,000 practical repair hints. For all types of radios. Hundreds of simplified tests using a 5c resistor and any filter condenser. Introductory material for beginners and to serve as review for experienced radio men. Several chapters on test equipment. Complete plan in manual form, 64 job sheets, data on all tubes, large size: 8½x11 inches. Schematics, pictures, charts. Sold on no-risk trial. Use coupon to order.

### NO TESTERS NEEDED REPAIR ANY RADIO IN MINUTES

This newly developed method tells you how to locate the source of trouble in any radio set without equipment. Make needed tests, measure voltage, trace the signal, by using only a 5c resistor, small condenser, and a crystal detector. Inject signals without any signal generator. Test parts by the new *Comparison* method. Test tubes without equipment. Repair any radio expertly following simplified picture plans. Improve your radio servicing ability. Data on all sets, portables, AC-DC, FM, recorders, intercoms, P.A. Examine and apply the plan for 10 days without obligation or risk. Send trial coupon today →

#### NO RISK TRIAL ORDER COUPON

### SUPREME PUBLICATIONS

9 S. Kedzie Ave., Chicago 12, Illinois

Ship postpaid the new complete Simplified Radio Servicing by Comparison Method manual for 10 days' examination. I am enclosing \$1.50, full price. I must be entirely satisfied or you will refund my total remittance.

NAME: .....  
ADDRESS: .....



*Liberty Leads in*

## RADIO PARTS and EQUIPMENT

SIGNAL CORPS JACK BOX  
BC-1366

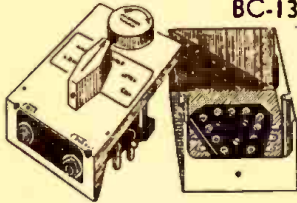

Cast aluminum box held together by 11 banana plugs; 2 jacks, 1 single and 1 double circuit, potentiometer, and double deck hand switch. Single unit 59c. Lots of 10 45c. Lots of 100 38c.

### OIL-FILLED CONDENSERS

.1 MFD-3000 V (round can) .....	\$1.25
.25 MFD-600 V .....	.10
.4 MFD-600 V .....	.10
.5 MFD-400 V .....	.10
.5 MFD-600 V .....	.10
.6 x .6 x .6 MFD-90 V, 60 cycle .....	.75
.05 x .05 x .05 MFD-150 V .....	.75
.22 x .22 x .22 MFD-300 V .....	.75
1.0 MFD-400 V .....	.60
1.0 MFD-2000 V .....	1.50
1.2 MFD-600 V .....	.75
2.0 MFD-600 V .....	.75
2.0 MFD-1000 V .....	1.00
2.0 MFD-1500 V .....	1.25
2.0 MFD-2000 V .....	1.50
4.0 MFD-600 V .....	.60
4.0 MFD-1000 V .....	1.00
5.0 MFD-330 V, 60 cycle .....	.60
5.0 MFD-150 V, 500 cycle .....	.50
5.0 MFD-300 V .....	.50
5.0 MFD-600 V .....	.50
6.0 MFD-1500 V .....	1.50
7.0 MFD-600 V .....	.75
8.0 MFD-500 V .....	.60
9.0 MFD-600 V, 60 cycle .....	.60
12.0 MFD-330 V, 60 cycle .....	.60
14.0 MFD-600 V .....	.75
15.0 MFD-300 V .....	.75
20.0 MFD-330 V, 60 cycle .....	1.00
650.0 MFD-80 WV (Cornell-Dubilier) .....	1.00

SPECIAL PRICES ON LARGE QUANTITIES

### RECORD CHANGERS

Detrola—late model .....	\$16.50 net
Crescent—late model .....	\$17.50 net

### RADIO KITS

6 Tube "Super Het" .....	\$14.95
5 Tube "Super Het" AC-DC .....	\$12.95
Special 5 Tube "Super Het" with Slide Rule Dial .....	\$19.95

25% Deposit with order. Minimum order \$2.00.

**LIBERTY SALES CO., INC.**  
115 WEST BROADWAY · NEW YORK 13, N. Y.

## BUILDING A TELEVISER

(Continued from page 29)

audio amplifier. Apply an 8.3-mc amplitude-modulated signal to the grid of V1 through a 50- $\mu$ f capacitor and adjust trimmer C13 for maximum output from the audio amplifier. This will be an approximate adjustment of C13 and can be re-aligned later when actually receiving a signal.

### A Straight FM Receiver

The sound channels of the televiser may be converted into an experimental receiver for the new FM sound channels by making the following changes in the tuning components of the mixer and oscillator stages. The channel switch Sw2 and coils L1 through L12 are omitted. L13 and L14 are retained. Continuously variable tuning is required to cover the FM channels and a tuning condenser must be added to the mixer circuit. The conversion uses only two coils in a conventional antenna circuit. The new coils are wound as follows:

Coil	Turns	Wire size	Length (inches)
Ant.	1 $\frac{3}{8}$	24	$\frac{3}{8}$
Grid	2	18	2
Osc.	$\frac{3}{4}$	18	

The oscillator and mixer circuits are tuned by two 15- $\mu$ f condensers, cut down to approximately 5  $\mu$ f, shunted by 25- $\mu$ f air trimmers. The oscillator trimmer is adjusted so that the oscillator will cover from 96.25 to 116.25 mc. This may be checked with a calibrated regenera-

tive receiver or by Lecher wires. The mixer is tracked with the oscillator by adjustment of the trimmer and by varying the spacing between turns of the grid coil without changing the distance between the ends. After the circuits have

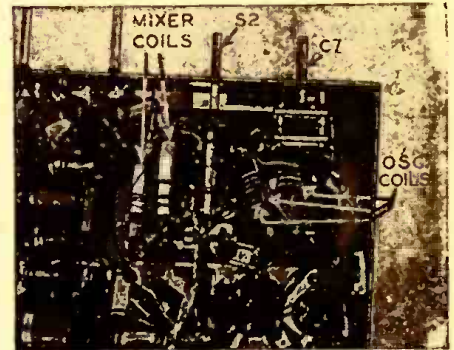

Photo C—Placement of the underchassis coils.

been tracked, ganged coupling may be used on the two condensers. The circuits will work most efficiently when they resonate with the trimmers at approximately minimum capacity.—Technical Staff, RADIO-CRAFT

This series on constructing a televiser will be concluded next month with a discussion on how to align the video receiver and select and install a suitable antenna.

### LIST OF PARTS

#### VIDEO SECTION

R1—65 ohms
R2, R75—500 ohms
R3—2,000-ohm pot.
R4—27,000 ohms
R5, R12, R17, R22, R29, R34—60,000 ohms
R6, R31, R103—6,000 ohms
R7, R30, R37, R71—2,000 ohms
R8, R89—25,000 ohms
R9, R32—3,000 ohms
R10, R15, R20, R25—70 ohms
R11, R16, R21, R26—100 ohms
R13, R18, R23, R46, R64—1,000 ohms
R14, R19, R24, R28, R53, R73—10,000 ohms
R27, R45, R51, R58, R61, R72, R88, R101—100,000 ohms
R33—150 ohms
R35—15,000 ohms
R36, R48, R52—5,000 ohms
R38, R-49, R57, R59, R94, R95, R96, R99, R100—1 megohm
R39—5,600 ohms
R40, R78, R87, R92, R93—500,000 ohms
R41—25,000 ohms—10 watts
R42—20,000 ohms—non-inductive
R43—3,500 ohms—10 watts—non-inductive
R44, R76—100,000-ohm pot.
R47, R65, R79, R80, R84, R85—2 megohms
R50—11,000 ohms
R54, R55—8,200 ohms
R56—1.2-meg pot.
R60—3-meg pot.
R62, R67, R68—3 megohms
R63—3,000 ohms
R66, R70, R74, R81, R102—50,000 ohms
R69, R82—4,600 ohms
R77—75,000 ohms
R83—40,000 ohms
R86—500,000-ohm pot.
R90, R91, R97—1-meg pot.
R98—240,000 ohms
C1, C2—4 to 50 $\mu$ f variable
C3, C4—3 to 20 $\mu$ f variable
C5, C6—2 to 12 $\mu$ f variable
C7—2 to 20 $\mu$ f variable
C8—33 $\mu$ f mica
C13—2 to 30 $\mu$ f variable
C9, C10, C11, C12, C14, C15, C20, C21, C28, C29, C35, C43, C44, C46, C47, C48, C73, C76—.006 $\mu$ f mica
C36, C37—25 $\mu$ f, 450 volts
C38, C39—16 $\mu$ f, 450 volts
C40, C41—.05 $\mu$ f, 600 volts
C42—4 $\mu$ f variable
C50, C56, C58, C66—.01 $\mu$ f, 450 volts
C53—.01 $\mu$ f, 600 volts
C51, C63, C65, C69—.25 $\mu$ f, 450 volts

C52, C55, C57, C59—8 $\mu$ f, 450 volts
C54—.00025 $\mu$ f mica
C60, C61, C62—.005 $\mu$ f mica
C64—.003 $\mu$ f mica
C67, C68—.05 $\mu$ f, 2500 volts, mica
C70—.000125 $\mu$ f mica
C71—.002 $\mu$ f mica
C72, C75—.001 $\mu$ f mica
C72, C75—.001 $\mu$ f mica
C74—.0005 $\mu$ f mica
C77, C78—.001 $\mu$ f, 2500 volts, mica
C79—.05 $\mu$ f, 450 volts
C80—.2 $\mu$ f, 2500 volts, oil filled
C81—.01 $\mu$ f, 1600 volts, oil filled
T1—Composite i.f. transformer
T2, T3, T4, T5, T6—Video i.f. transformer
T7—Vertical oscillator transformer
T8—High voltage power transformer
T9—Power transformer, 700 volts c.t., 150 ma
F1—10-ampere fuse
Sw1—Switch, s.p.a.t.
Sw2—Switch, 2-section, 4-pole, 3-position
Ch1, Ch2, Ch3—Filter choke, 10 henry, 150 ma
L1, L2, L3, L4, L5, L6, L7, L8, L9—Antenna coil
L10, L11, L12—Oscillator coil
L33, L35—300 $\mu$ h
L34—175 $\mu$ h
L36—250 $\mu$ h
L37—125 $\mu$ h

#### AUDIO SECTION

R101-X—50,000 ohms—10 W
R201—500,000 ohms
R202, R207—150 ohms
R203, R205, R207-A, R209, R212, R213—50,000 ohms
R204, R208—2,000 ohms
R206, R210—20,000 ohms
R211—150,000 ohms
R214, R215, R216—100,000 ohms
C101, C102, C103—16 $\mu$ f 450 volts
C201, C202, C203, C206, C207, C208—.006 $\mu$ f mica
C204, C205, C209, C210, C214, C215—2 to 25 $\mu$ f variable
C211—.0001 $\mu$ f mica
C212—.01 $\mu$ f 450 volt
C213—50 $\mu$ f mica
C216, C217—.0002 $\mu$ f mica
C218—.001 $\mu$ f mica
C219—.05 $\mu$ f 450 volt
T12—Power transformer 600 volts c.t., 60 ma; 6.3 volts, 2 amperes; 5.0 volts, 2 amperes
CH101—Filter choke 10 henry, 60 ma
RFC—2.5 mh



## TRANSATLANTIC NEWS

(Continued from page 35)

eter, inserted at the 400-ft. level. At the top of the mast is a new kind of adjustable capacity loading unit. This consists of four jointed radial booms, each 30 feet in length, with wires joining their extremities. At the 400-foot level there is a platform carrying a large variable inductor, which can be so adjusted that the greatest possible non-fading range is obtained. Previously, severe fading was liable to occur in districts of Kent, Surrey and Sussex, lying to the south-west of London. The new radiator is proving highly successful, providing fading-free reception in these districts.

### Blind Landings

Britain, as a good many G.I.'s discovered when they were over here, is liable to fogs in autumn and winter. For that reason the problem of blind landings at civil aerodromes is a particularly acute one. At present there is no international agreement on standardizing radio and radar systems of blind approach and landing at passenger and commercial aerodromes. It seems that it may be some time before the committee now considering the subject is able to come to decisions. Our authorities felt that something had to be done quickly. Rather than wait, they have gone ahead with the installation of a blind landing system. The one adopted is the American "talk-you-down" GCA. As an aid to blind navigation the Decca company has been authorized to operate its hyperbolic system, which makes use of very low-frequency continuous waves. This does not mean that we have washed our hands of the international committee. If they decide on different systems, we'll adopt them.

### Insured Radio Maintenance

Radio servicemen will be interested in a scheme for the guaranteed maintenance of receiving sets which has been launched in this country and is proving popular with customers. It is working well from the dealer's point of view, since it assures him both a steady income and a steady flow of work. Briefly the scheme is this: when he purchases a new radio the customer is offered a complete insurance against defects and breakdowns of every kind. In return for an annual payment the dealer undertakes to make a thorough check-up each year as a matter of routine; to do any trouble-shooting, adjustments or repair work that may be required; to replace free of charge any tubes or components that become faulty. Average terms are 75 cents per year for each tube the set contains. Higher premiums are charged as the radio advances in age. The charges—\$3.75 for a 5-tube, or \$4.50 for a 6-tube radio—must be considered in connection with the fact that tubes (which are the most likely parts to need replacement) cost a great deal more than in the United States.

# JUST PUBLISHED!

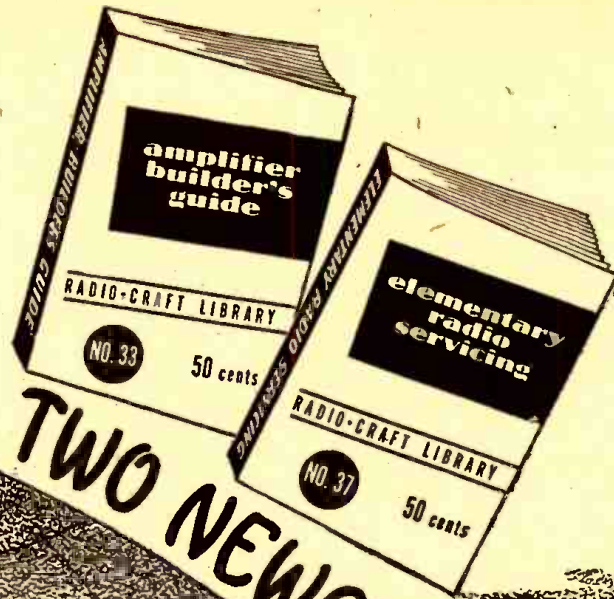

## TWO NEWCOMERS TO...

HERE are two brand-new books, just off the press—both important additions to RADIO-CRAFT'S 1946-7 NEW MODERN LIBRARY SERIES. Last month five other fresh titles were announced (see list to the right). Watch this page for further titles each month.

"Easy-to-read, easy-to-grasp, easy-to-apply"—is the best way to describe the books in this popular series. Let them be your working tools to a better understanding of radio—to help you achieve higher goals. You will like the handy size, the fresh up-to-date type, the good printing, the carefully drawn schematics, and the flexible covers in attractive modern dress. 64 pages. Price 50c each, post-paid.

#### NO. 33 AMPLIFIER BUILDER'S GUIDE

A valuable book for the designer and constructor of sound equipment. Theory and construction of audio amplifiers are treated in separate parts. The theory section contains an unusually wide range of technical information on such subjects as r-c amplifiers, phase inverters, equalizing phonograph pickups and volume expansion.

#### NO. 37 ELEMENTARY RADIO SERVICING

A book for the radio man who knows little about radio repair. It shows how to get started and keep going. A wide range of essentials is covered in logical sequence: Planning and Equipping the Shop, Systematic Circuit Checks, Signal Tracing Methods, Servicing Midget Receivers and other fundamental servicing topics.

SEE YOUR DEALER.

IF HE CAN'T SUPPLY YOU. USE COUPON.

#### RAD-CRAFT PUBLICATIONS

25 W. Broadway, New York 7, N. Y.

Kindly send me the volumes (50c each, postpaid) checked.

ALL 7 BOOKS

No. 29

No. 30

No. 32

No. 33

No. 36

No. 37

No. 38

I enclose \$.....

Name .....

Address .....

# RADIO CRAFT NEW MODERN LIBRARY SERIES

50¢ each

Here Are Five Other Recent Titles

- # 29 HANDY KINKS AND SHORT CUTS
- # 30 UNUSUAL PATENTED CIRCUITS 1944-1946
- # 32 ADVANCED SERVICE TECHNIQUE
- # 36 RADIO TEST INSTRUMENTS
- # 38 HOW TO BUILD RADIO RECEIVERS



# LEEDS

## SPECIAL

BC-645A Brand New. Complete with tubes, including W. E. 316A "Door Knob". 460-490 MC. Can be converted to the 420-450 MC Ham Band. Detailed conversion & diagrams supplied.

**\$14.95**

## SELSYN MOTORS

115V 60 cycle Type 5, all Perfect-Guaranteed, per pair ..... \$5.00  
115V 60 cycle Type II-1 mounted in armored case and with indicated scale.

**PER PAIR \$9.00**

## ARMY RADIO PHONES



They're perfect and were O.K.'d by Signal Corps inspectors. For battery-less phone or recordings, etc. Complete dynamic hand mike, 2 earphones, head-band, cord set and special connecting cord set. A real special **\$3.45** ONLY

### Laboratory Precision Variable Condenser

45-1500 mmf designed for use in general radio 605-B Signal Generator  
Special \$3.00  
CARDWELL XE 240 XS 30-240 mmf Variable .100 Airgap Mycalex insulated, \$2.95

Aerovox 0.1 mfd 7500 vdc Oil Condenser \$1.50  
C-D 2 mfd. 2000 vdc " " 2.25  
C-D 4 mfd 2000 vdc " " 3.50  
Aerovox 8 mfd 1500 vdc " " 3.45

Cornell Dubilier 2mfd 10,000 VDC Oil Special \$12.95

Westinghouse 3" Bake Case 0-20 ma \$2.45  
Weston 2" " " 0-1 ma 500 V Scale 3.50

Heineman 115 Volt 5 Amp. Magnetic Circuit Breaker. \$9.95

In Stock: New Type General Radio Co. Variacs  
Type V-5 115V input 0-135V output @ 5 Amps 860 Watt. \$18.15  
Type 200 B 115V input 0-135V output @ 1 Amp 170 Watt. 12.65

If not rated 25% with order, balance C.O.D. All prices F.O.B. our warehouse New York. No order under \$2.00

We ship to any part of the globe

# LEEDS RADIO CO.

75 Vesey St., Dept. 45  
Cortland 7-2612 New York City 7

## WORLD-WIDE STATION LIST

(Continued from page 37)

Freq.	Station	Location and Schedule
6.160	CBRX	VANCOUVER, CANADA: 0900 to 0250
6.160	HHCM	PORT-AU-PRINCE, HAITI: 0500 to 0830; 1100 to 1400; 1700 to 2145
6.160	HER3	BERNE, SWITZERLAND: 0020 to 0120; 0245 to 0700; 1200 to 1700
6.230	HRD2	LA CEIBA, HONDURAS: 1200 to 1300; 1900 to 2300
6.240	HJCF	BOGOTA, COLOMBIA: 1700 to 2300
6.240	HIIN	CIUDAD TRUJILLO, DOMINICAN REPUBLIC: 1600 to 2230
6.280	HCJB	QUITO ECUADOR: 1800 to 2200
6.190	HIIA	SANTIAGO, DOMINICAN REPUBLIC: 1600 to 1800
6.200	HJCT	BOGOTA, COLOMBIA: 1000 to 1400; 1800 to 2315
6.200	YV6RD	CIUDAD BOLIVAR, VENEZUELA: 1700 to 2315
6.310	HIIZ	CIUDAD TRUJILLO, DOMINICAN REPUBLIC: 1600 to 2235
6.330	COCW	HAVANA, CUBA: 0000 to 2400
6.340	HEI2	BERNE, SWITZERLAND
6.360	HRP1	SAN PEDRO DE MINDURAS: 1100 to 1415; 1800 to 2255
6.370	CSX	LISBON, PORTUGAL: 1330 to 1900
6.450	COHJ	SANTA CLARA, CUBA: 0700 to 2345
6.480	HI2T	MONSIGNOR NOEL, DOMINICAN REPUBLIC: 1600 to 2400
6.510	CP40	COCHAHAMBA, BOLIVIA: 1930 to 2200
6.530	TGWB	GUATEMALA CITY, GUATEMALA: 0800 to 1200; 1830 to 0100
6.620	TG2	GUATEMALA CITY, GUATEMALA: 1800 to 2300
6.710	ZLT7	WELLINGTON, NEW ZEALAND: 0415 to 0430
6.720	PMA	BANDDENG, NETHERLAND INDIES
6.750	JVT	TOKYO, JAPAN
6.760	YNDS	MANAGUA, NICARAGUA: 0800 to 1000; 1700 to 2330
6.770	CP49	LA PAZ, BOLIVIA: 0700 to 0900; 1100 to 1200; 1930 to 2100
6.770		SINGAPORE, MALAYA: 0345 to 0835
6.850	YNOW	MANAGUA, NICARAGUA: 0800 to 2400
6.910	YNQW	MANAGUA, NICARAGUA: 1300 to 2300
6.980		MOSCOW, U.S.S.R.: 1600 to 1745; 2215 to 2345
6.980	F08AA	PAPEETE, TAHITI: Tuesdays and Fridays, 2200 to 2400
7.010	XPSA	KWEIYANG, CHINA: 2330 to 0030; 0430 to 0900
7.100		BISSAU, PORTUGUESE GUIANA: 1600 to 1730
7.120	GRM	LONDON, ENGLAND: 1145 to 1215; 1445 to 1515
7.130		HARGEISHA, BRITISH SOMALILAND: 0800 to 1030; 1200 to 1300
7.150	XGOY	CHUNGKING, CHINA: 0630 to 1130
7.160		VIENNA, AUSTRIA: 0000 to 0200; 0600 to 0800; 1000 to 2030
7.190	JCPA	CAIRO, EGYPT: 0200 to 0300; 1500 to 1715; 2230 to 2400
7.210	FGY	DAKAR, FRENCH WEST AFRICA
7.210	VLQ2	BRISBANE, AUSTRALIA: 0230 to 0830
7.220	JCKW	JERUSALEM, PALESTINE: 2330 to 0130
7.220	GSW	SINGAPORE, MALAYA: 2230 to 0130
7.220		LONDON, ENGLAND: 0100 to 0115; 0130 to 0230; 0500 to 0645; 0700 to 0730; 0745 to 0900; 1045 to 1130; 1230 to 1430; 1530 to 1715
7.240	VLQ	BRISBANE, AUSTRALIA: 1500 to 1900
7.250	PJCI	WILLEMSTAD, CURACAO: 1130 to 1230; 1630 to 2130
7.250	GWI	LONDON, ENGLAND
7.260	GSU	LONDON, ENGLAND: 2345 to 2400; 0030 to 0200; 0630 to 0645; 0700 to 0800; 0815 to 0900; 1045 to 1300; 1330 to 1700

The Patent Office reports an 81 per cent increase in patent applications awaiting action during the past year. Pending applications in the radio field more than doubled during the year.

## Get Started in Radio



10 "HOW-TO-DO-IT" BOOKS  
Get a solid foundation in radio by means of these 10c timely text books. Each clearly written, profusely illustrated, contains over 15,000 words. You'll be amazed at the wealth of information packed into these handy books. Excellent for reference—ideal for technical library. Your money back if not satisfied.

5 BOOKS for 50c  
10 BOOKS for \$1.00  
Sent to You Postpaid

- No. 1—How To Make Four Doodle Short Wave Sets
  - No. 2—How To Make The Most Popular All-Wave 1 and 2 Tube Receivers
  - No. 3—Alternating Current for Beginners
  - No. 4—All About Aerials
  - No. 5—Beginners' Radio Dictionary
  - No. 6—How To Have Fun With Radio
  - No. 7—How To Read Radio Diagrams
  - No. 8—Radio for Beginners
  - No. 9—Simple Electrical Experiments
  - No. 10—Television
- Remit by check or money order—register letter if you send cash or stamps.  
RADIO PUBLICATIONS, 25A West B'way, New York (7)

## HARD-TO-GET PARTS

### POWERFUL ALL-PURPOSE INDUCTION MOTOR

IDEAL FOR EXPERIMENTERS—101 USES



Sturdily constructed to precision standards, this self-running shaded pole A.C. induction motor is powerful enough for a number of uses. Some of these are: Automatic Timing Devices, Current Interrupters, Electric Fans, Electric Chimes, Window Drives, Photocell Control Devices, Electric Vibrators, Small Grinders, Buffers and Polishers, Miniature Pumps, Mechanical Models, Sirens, and other applications.

Consumes about 15 watts of power and has a speed of 3,000 r.p.m. When geared down, this sturdy unit will constantly operate at 18-inch turntable loaded with 200 lbs. dead weight. THAT'S POWER!  
Dimensions 3" high by 2" wide by 1 3/4" deep; has 4 convenient mounting studs; shaft is 1/8" long by 3/16" diameter, and runs in self-aligning oil-retaining bearings. Designed for 110-20 volts, 60-60 cycles, A.C. only. Sup. Wt. 2 lbs.  
ITEM NO. 147  
YOUR PRICE ..... **\$2.95**

### ULTRA MAGNET

LIFTS MORE THAN 20 TIMES ITS OWN WEIGHT  
LITTLE GIANT MAGNET  
Lifts 5 lbs. easily. Weighs 4 oz. Made of ALNICO new high-magnetic steel. Complete with keeper. World's most powerful magnet ever!  
The experimenter and hobbyist will find hundreds of excellent uses for this high quality permanent magnet. Measures 1 3/4" x 1 1/2" Shp. Wt. 3/4 lbs.  
ITEM NO. 159  
YOUR PRICE ..... **\$1.50**



### GENUINE MICROPHONE TRANSMITTERS

Regular telephone transmitters taken from a large telephone supply company's overstock. Work perfectly on 2 dry cells. No adjustment on P.A. systems, call systems, intercommunications, etc. a. s. short-line telephone circuits, house-to-house or farm-to-farm phone lines, also to talk through your radio or as concealed dictaphone pick-up. Useful replacement on battery-operated rural telephone lines.  
THESE ARE GENUINE TRANSMITTERS. MADE BY KELLOGG, WESTERN ELECTRIC AND STROMBERG-CARLSON, excellent in appearance and operation. No value and one seldom offered in these times. Shp. Wt. 1 lb.  
ITEM NO. 160  
YOUR PRICE ..... **\$2.10**

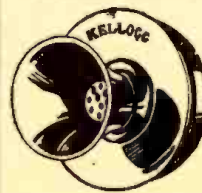

### AMAZING BLACK LIGHT!!

Powerful 250-Watt Ultra-Violet Source  
The best and most practical source of ultra-violet light for general experimental and entertainment use. Makes all fluorescent substances brilliantly luminescent. No transformers of any kind needed. Fits any standard lamp socket. Brings out beautiful opalescent hues in various types of materials. Swell for amateur parties, plays, etc., to obtain unique lighting effects. Shp. Wt. 3 lbs.  
ITEM NO. 87  
YOUR PRICE ..... **\$1.95**



### WESTERN ELECTRIC BREAST MIKE

This is a fine light-weight aircraft carbon microphone. It weighs only 1 lb.  
Mike comes with broseplate mounting and has 2-way swiveling adjustment so that it can be adjusted to any desired position. There are 2 woven straps; one goes around neck, the other around chest. Straps can be snapped on and off quickly by an ingenious arrangement.  
This excellent mike can be adapted for home broadcasting or private communication systems. By dismounting broseplate, it can be used as desk mike.  
Comes complete with 6-foot cord and hard rubber plug. Registered in unadorned plate, non-rustable. Shipping weight, 2 lbs.  
ITEM 152  
YOUR PRICE ..... **\$1.49**



### WATTHOUR METER

Completely overhauled and ready for immediate service. Designed for regular 110-volt, 60 cycle 2-wire A.C. circuit. Simple to install; 2 wires from the line and 2 wires to the load. Sturdily constructed in heavy metal case, 8 1/2" high, 6 1/2" wide, 5" deep. Westinghouse, G. E. Co., Fl. Wayne, Sankamo or other available make Shp. Wt. 14 lbs.  
ITEM NO. 33  
YOUR PRICE ..... **\$5.95**



### HUDSON SPECIALTIES CO.

40 West Broadway, Dept. RC-2-47, New York 7, N. Y.  
I have circled below the numbers of the items I'm ordering. My full remittance of \$..... (including shipping charges) is enclosed (NO C.O.D. ORDERS UNLESS ACCOMPANIED WITH A DEPOSIT.)  
OR my deposit of \$..... is enclosed (20% required), ship order C.O.D. for balance. NO C.O.D. ORDER UNDER \$5.00. BE SURE TO INCLUDE SHIPPING CHARGES.  
Circle Item No. wanted:  
147 159 160 87 152 33

Name .....

Address .....  
Please Print Clearly

City ..... State .....



## SIMPLE FREQUENCY MONITOR

(Continued from page 21)

as the wavemeter is tuned through resonance, or a meter in the grid or plate circuits of the oscillator will deflect at resonance. Another method is to measure the power absorbed in the wavemeter itself. This can be done with a pilot bulb or other r.f. indicator.

One of the important uses of a wavemeter is in aiding VFO design. Coupling the meter shows at once whether the oscillator is above or below the desired frequency, thus simplifying the work and saving time. Many transmitters use high-sensitivity pentodes and frequency multiplication. In such cases it is altogether too easy to mistake one harmonic for another. Here the wavemeter is almost indispensable to keep from going out-of-band. It is also necessary when using the popular pi-network and similar antenna coupling systems. In such cases, a change in the tuning condenser is accompanied by an op-

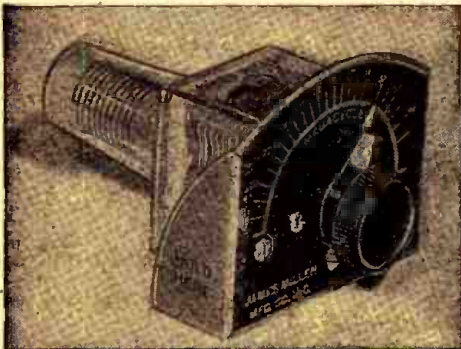

Commercial type made for high frequencies.

posite change in the coupling condenser. Thus, it is possible to have a variety of condenser settings for the same band, and, in turn, the same tuning settings may apply to more than one band. The wavemeter gives a positive indication in all cases.

Since the wavemeter does not require precise calibration or special low-loss construction, many hams prefer to construct their own unit, incorporating whatever special features they require. One home-made job is shown in the photo. It is made up of parts available in any shack. The condenser is a double-unit broadcast type (two 365  $\mu\text{f}$  sections in parallel). The wide capacitance range makes it possible to cover the 80, 40 and 20 meter bands without plug-in or switching troubles. The coil is wound on a 2½-inch long, ¾-inch diameter lucite rod extending from the rear of the condenser. There are 18 turns of No. 20 wire closely-spaced in the coil, which is wound at the further end of the rod. This makes it possible to insert the coil into practically any size and shape of tuned circuit for measurement. A No. 47 pilot bulb is soldered directly to a condenser lug.

Calibration is simple. The 80-meter band is found by using an 80-meter crystal and tuning to the lowest frequency of the transmitting oscillator. In this case the coil was designed by

**THE SECRET'S OUT!**

*The New and Spectacular*  
**ACA-100DC AMPLIFIER**  
*Is Ready For Delivery!*

DESIGNED BY A. C. SHANEY



A revolutionary development in amplifiers cleverly designed to defy obsolescence and amazing in its performance. New circuits, new materials and new processes are actually combined in this one amplifier to produce the most satisfying musical amplifier the world has ever known. If you are one of those discriminating persons for whom nothing less than the best is a disappointment, you are one for whom the ACA-100DC was designed. Send for technical literature.

**AMPLIFIER CORP. of AMERICA**

398 Broadway, New York 13, N. Y.

A. C. Shaney's FM-AM AMPLIFIER MANUAL is still available at 25c

NEW

**SILVER "SPARX"**

**DYNAMIC SIGNAL TRACER**



Touch "SPARX" prod to grid, to plate, of every receiver circuit. You'll localize trouble in 30 seconds per tube—trouble in a five-tube receiver located in 2½ minutes! True dynamic signal tracing at r.f., i.f., a.f. — plus indication of presence or absence of a.c. and d.c. operating voltages, hum or distortion. Tests phono pickups, microphones, amplifiers, speakers—"SPARX" is your shop test speaker, too—all with visual and audible signal tracing. "SPARX", radio's complete signal tracer-tester, will earn its low cost for you in no time flat.

◀ New post-war design and construction, but low pre-war price, explains why wise service technicians buy it by the thousands. Matching "VOMAX", 904 Laboratory C-R Bridge, 906 AM FM Signal Generator in size and style, "SPARX" is the same outstanding "buy". At only \$39.90 it will earn you, too, more profits than any other instrument you've ever bought.

OVER 35 YEARS OF RADIO ENGINEERING ACHIEVEMENT

*McMurdo Silver Co., Inc.*

1240 MAIN ST. HARTFORD 3, CONNECTICUT

Send postcard for catalog of new measuring equipment, communication receivers, transmitters, kits and parts. See them at your favorite jobber.

pushing the 80-meter calibration as far as possible towards the high-capacitance setting so that ample room would be available for 20 meters and below at the other end. The 40-meter point is found both by using a 40-meter crystal and tuning in the second harmonic of the 80. This serves as a double check against using the wrong harmonic. Similarly, the 20-meter point is found by using the second harmonic of 40 and the fourth of 80.

To make a measurement, simply insert the wavemeter into an oscillating coil and tune the wavemeter for maximum brilliance. Then read the calibration. It is well to proceed cautiously at first unless there are plenty of bulbs on hand. Even 20 watts input to an oscillator or amplifier can easily burn out the wavemeter bulb. For more accurate indication, withdraw the wavemeter until the filament just barely glows.—W2OUX.



*In New Jersey...*

*...it's VARIETY*

**SUPERIOR  
Model 670  
Super-Meter  
A Combination**

Volt-Ohm Milliammeter  
plus Capacity Reactance  
Inductance and Decibel  
Measurements.



Complete with test leads and instructions ..... **\$28.40**

**RADIO KITS by "EASY BUILT"**

**Model No. 2 Kit**

-AC-DC Electric Battery  
Kit with Cabinet com-  
plete with Tube, Spe-  
cial Variable Condens-  
er, Earphone, Resis-  
tors, Hardware and  
Special Fittings, Com-  
pletely Wired Tube  
Socket, Diagram on  
Mounting Base—Ready  
Cut and Drilled.



**\$5.01 each**

**Model No. 2B** Battery operated, easy tuning,  
attractive wood finish cabinet.  
Complete with Tube, Coll. Battery, Headphone, Hard-  
ware and Base. List Price—Special **\$3.33**

Kit No. I ..... \$2.13  
Kit No. IX ..... \$2.13

**Federal Teleco SELENIUM RECTIFIER**  
Replaces Rectifier Tube..... \$1.09 each  
6 or more ..... 99c each

**PHONO MOTOR—with TURNTABLE**

60 Cycles 115 Volts **\$3.95**

Suitable for every pho-  
nograph instrument  
where low cost and  
dependable perfor-  
mance are required.



**\$3.95**

**Famous Brand  
VOLUME CONTROLS with SWITCH**  
**75c each 10 for \$6.96**

5,000, 10,000, 25,000, 50,000, .1 meg, .25 meg, .35  
meg, .35-meg 70,000 ohm tap, .5 meg, .5 meg 50%  
tap, 1 meg, 1 meg 50% tap, 2 meg 50% tap. Out-  
side diam 1 1/4", shaft length 3", flat 1/4".

**RESISTOR CABINETS—All wood con-  
struction. Six shelves, 24 compartments** **\$3.89**

**R.C.A.-T65 CABINET**

Packed in original carton. Beautiful inlaid veneer  
with grill cloth. Speaker baffle for 5" speaker. Rubber  
feet.

**\$4.95 each. Three for \$14**

**Bargain! Guaranteed!**

**100 Assorted Bypass Condensers**

- |              |                     |
|--------------|---------------------|
| 10-001-600V. | 10-02-600V.         |
| 15-002-600V. | 10-05-600V          |
| 10-005-600V. | 10-1-600V.          |
| 15-006-600V. | 10-5-200V.          |
| 10-01-600V.  | Value ..... \$11.00 |

**Special—\$6.95**

**SPECIAL!** 20 x 20 150 WV. Electrolytic con-  
densers. Fresh stock guaranteed.  
Value \$8.75 **10 for \$4.95**

Write Dept. C-2 for our FLYER. 20% Deposit  
with order required. Please add sufficient post-  
age. Excess will be refunded.

**Variety ELECTRIC CO., Inc.**  
**601 Broad St., Newark 2, N. J.**

**PROBLEMS OF INSTABILITY**

*(Continued from page 25)*

resistors in series with the amplifier grid and/or plate leads; rearranging the chassis ground-return and voltage supply connections; etc.

Such minor circuit design alterations change the more or less unpredictable stray and conduction coupling factors and may counteract regenerative effects with sufficient degeneration to stabilize the circuits.

At times, the instability problem may lie in uni-stage oscillation or parasitic oscillation in a single amplifier stage, because of stray grid-to-plate coupling effects. This type of circuit instability is rather infrequent in the case of modern tubes.

An obscure source of circuit instability is the resistance-rectification connection problem caused by corroded or defective riveted, bolted, soldered, spot-welded or sliding-contact junctions in radio or sound amplifier circuits. Such non-linear resistance connections may not only cause oscillation but also loss in signal strength, hum and distortion effects which are at times difficult to track down.

**Service and Repair Notes**

In repairing a piece of equipment, the original wiring should not be disturbed, to avoid changing the original stray circuit coupling factors. Similarly, when replacing defective circuit components, the exact replacement part or an equivalent should be used and replaced in exactly the same position.

If an amplifier tube shield, by-pass condenser, isolating resistor or choke or circuit shield has apparently been "omitted" in one or two of the amplifier stages, do not insert one in an attempt

to correct the "error." It may eliminate a stray coupling factor which was deliberately inserted to introduce a controlled amount of degeneration to suppress oscillation tendencies. Or it may have created a small amount of regeneration to increase gain and peak the tuning.

If a peculiar circuit design or arrangement or unorthodox wiring location is noted in the wiring diagram or in the equipment itself, it should not be "fixed up" by eliminating it or altering it to standard circuit design. Again, intentional stray coupling factors may be disturbed and satisfactory circuit operation upset.

Chassis ground return or voltage supply connections made anywhere on the chassis or at any point in the voltage supply bus wiring are not always the "same thing." At radio frequency levels, a few inches of chassis or wiring has appreciable impedance and inductive and capacitive coupling effects. Instability troubles may crop up if these original wiring connections are juggled about.

Some receivers develop oscillation or excessively peaked tuning tendencies when all the r.f. or i.f. stages are lined up too accurately with signal generators and c.r. oscilloscopes or output meters. Such receivers perform more satisfactorily on an alternately staggered slightly off-tuned basis, and represent an exception to the general rule "a job well done pays off in the end."

At times, defective corroded connections develop in a circuit to produce operational troubles. Such non-linear resistance connections may be tracked down with a low-range ohmmeter, re-

**RADIO TERM ILLUSTRATED**



B Batteries

Suggested  
by T. F. Behannon  
Houston, Texas



sistance bridge or a cathode-ray scope and signal generator combination.

### Modernization Notes

Care must be exercised in altering tube types in a piece of equipment, especially when shifting to higher-mu tubes.

In the old receivers using triodes in the r.f. or i.f. stages, the neutralizer stabilizing circuits have been designed for a specific set of tube and circuit stray capacitances and inductances. When such tube types are altered, some trial-and-error modifications of the neutralizer circuits may be necessary to prevent unstage oscillation.

When considerably higher-mu tubes are inserted into amplifier stages, the resultant higher signal voltage levels may increase the inter-stage coupling, causing oscillation and hum pick-up. Increased circuit shielding, rearrangement of wiring and components, increased bypass filtering and omission of one amplifier stage may be necessary to eliminate the instability.

In substituting diode detectors for grid-leak or biased detectors, it should be remembered that although diodes are "non-amplifying," it is quite possible for them to develop oscillation effects when a tuned r.f. circuit is present in the diode stage. Oscillation and hum pick-up may take place if inadequate shielding and excessively long wiring leads exist in the high-fidelity diode detector stage.

In wiring up new power amplifier stages, precautions must be taken against parasitic oscillation, especially in push-pull-parallel stages where an electronic "hunt" type of h.f. oscillation apparently takes place. Cases have been known in transmitter installations where about a dozen varieties of parasitics have been successively developed by power amplifiers with each circuit modification before being finally suppressed.

Such parasitics may result in hums, birdies, whistles, distortion, loss in output, excessive plate currents and overheated tubes which sometimes cause a radioman to pull apart all of a transmitter's or receiver's circuits except the one actually causing the trouble.

In radio receivers, grounding the speaker chassis and voice coil, shielding the speaker leads, inserting mica shunt condensers in the power amplifier grid or plate load circuits, inserting non-inductive low-resistance series resistors in the amplifier grid circuits, arranging the power amplifier stage components to produce the shortest and most direct wiring leads, keeping the wiring out in the clear from other wiring and components, shielding the power amplifier tubes with roomy and well-ventilated shields, etc., are some of the methods which can be applied to suppress parasitics, if and when they crop up.

Receiver power amplifier parasitics can be checked by removing the detector tube. If the trouble is in the r.f. or i.f. stages, the whistles and hums will cease. If not, the trouble is obviously parasitics in the power stage. The trouble-making stage can be checked

## CRESCENT Automatic RECORD CHANGER



### Model C-100

- Physical Size: 15 $\frac{3}{4}$ " x 12 $\frac{1}{2}$ "
- Plays Twelve 10" or Ten 12" Records
- Noiseless
- Child-proof Mechanism
- Crystal Cartridge
- Reject Button
- Finished in Neutral Beige Crackle

**RECORD CHANGER ONLY \$1950**  
Your Cost Each

#### LEATHERETTE BASE AS ILLUSTRATED Above—Model H-100

Brown Finish, Made to Fit  
Model C-100 Record Changer.  
6" High, with Grille for 5"  
Speaker. **\$4.25 ea.**

Orders are now being accepted for immediate delivery—no waiting. Terms: 2% check with order. Or 25% deposit, balance express C.O.D.

PM SPEAKERS	
4" Alnico (5) PM Speaker.....	\$1.39 ea.
5" Alnico (5) PM Speaker.....	1.49 ea.
6" Alnico (5) PM Speaker.....	1.89 ea.

PHONO AMPLIFIERS	
1-Tube Phono. Amplifier.....	\$2.35 ea.
3-Tube Phono. Amplifier.....	4.50 ea.

TUBULAR ELECTROLYTICS	
100-MFD-25 V... \$ .22 ea.	10-MFD-450 V... \$ .29 ea.
10-MFD-50 V... .22 ea.	16-MFD-450 V... .39 ea.
20-MFD-150 V... .22 ea.	10-10-MFD-450 V... .59 ea.
30-MFD-150 V... .29 ea.	20-20-MFD-150 V... .29 ea.
40-MFD-150 V... .39 ea.	30-20-MFD-150 V... .39 ea.
50-MFD-150 V... .45 ea.	40-30-MFD-150 V... .45 ea.
8-MFD-450 V... .25 ea.	50-30-MFD-150 V... .59 ea.

**HOLLANDER RADIO SUPPLY CO.**  
**549 West Randolph Street Chicago 6, Illinois**

effectively with a sine-wave or square-wave signal generator and a cathode-ray scope. A sine-wave audio signal sent through the power amplifier stage will show up as a sine-wave modulated by a fuzzy r.f. ripple when the scope's "V" and "H" amplifier gain is turned up. A square-wave signal will show a small "pip" close to the leading corner which indicates a h.f. oscillatory transient condition of the circuit.

A simple and practical test is to touch the power amplifier grid circuits with a tool held in the bare hand or else to shunt the grid or plate circuits to ground through small mica condensers. This will result in clicks and shift in the oscillation noise in the speaker or a complete cessation of oscillation. If no change is noted in the birdies or hums, the trouble is obviously in the r.f. or i.f. stages.

Minor circuit alterations which obviously do not, as a rule, result in instability problems, are: increasing the power supply hum filters, replacing glass-envelope amplifier tubes with metal-envelope types, replacing old type audio transformers with new high-fidelity types, substituting impedance coupling for transformer coupling between audio amplifier stages (with moderate-sized coupling condensers), replacing old speakers with modern types, replacing grid-leak detectors with biased detectors, replacing two or three low-mu audio amplifier stages with one or two medium-mu or high-mu amplifier stages (respectively), in-

(Continued on page 68)

## RADIO PARTS SOUND SYSTEMS ELECTRONIC APPARATUS

Depend on  
RADOLEK

Radolek's big Free Profit Guide Catalog and Profit Bulletin supplements keep you abreast of the rapidly changing radio situation. Buying from Radolek means greater values, better service and more profits. Make Radolek your buying headquarters.



**RADIO PARTS**  
**SOUND SYSTEMS**

FREE CATALOG

**Large Stocks  
Fast Service**



SEND TODAY!

RADOLEK CO., Dept. C-114  
601 W. Randolph St., Chicago 6, Ill.  
Please send your FREE Profit Guide Catalog.

Name \_\_\_\_\_  
Address \_\_\_\_\_

SAVE AT RADOLEK



# A Complete Business System

The "Radio Service Standard Rate Book"  
Price: \$1.00

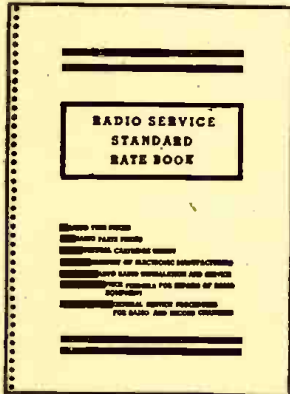

A comprehensive pricing system and Code of Ethics designed to aid the Radio Service Dealer to establish fair and equitable rates for the servicing of radios.

The book is divided into six sections, covering auto radios, A.C. D.C. battery portables, console radios, table model radios, record players and record changers.

Each section outlines the general servicing procedures for each type of set and lists standard rates for various types of repair service.

Parts prices and tube prices are conveniently listed, plus suggested standard rates for labor, service calls, pickup and delivery, estimates and alignment.

Includes Crystal Cartridge Digest, showing illustrations, voltages, pressures and list prices.

Also includes registry of electronic manufacturers of radio and appliance items.

The "Radio Service Work Sheet"  
Price: 60c (50-sheet pad)



Complete servicing and pricing details on your service job are outlined on the "Radio Service Work Sheet." Reverse side illustrates your method of pricing.

Rates for service calls, labor, etc., are listed and explained. A space is provided for the dealer to insert his name with rubber stamp.

A valuable asset to gain customer confidence and good will and a reputation for fair dealing.

The "Radio Service Record"  
Price: \$1.25 (100-sheet book)



Provides a comprehensive record system of every repair job, showing all materials used, labor, time, etc.

The "Radio Service Record" is ring-bound and contains consecutively-numbered job tickets designed as a file card, customer's claim check (with space for dealer's rubber stamp), and radio repair tag.

A convenient way to order: 500 lots (5 books), with numbers running consecutively. Price \$6.25.

Available at your Radio Parts Jobber

Oelrich Publications

1627 South Keeler Avenue Chicago 23, Ill.

## PROBLEMS OF INSTABILITY

(Continued from page 67)

serting r.f. filtering in the power line and power supply circuits, etc., etc.

Under certain conditions, altering existing equipment circuits may result in such serious oscillation instability that all the usual methods will fail to suppress it. Only a major reshuffling and trial-and-error rearrangement of circuit components, wiring and shielding on a new chassis may result in sufficient reduction of circuit coupling to result in stable circuit operation.

### Construction Notes

A new or untried design should not be built in a permanent form but rather as a rough experimental model, especially where multi-stage high-gain circuits or inadequately shielded or portable equipment is involved. This will allow elimination of instability and operational "bugs" by trial-and-error.

Generally speaking, the more shielding employed, the more stable the circuit operation and the lower the stray signal and hum pick-up effects. Under certain conditions, increased shielding may increase rather than decrease circuit instability. Shielding alone cannot suppress oscillation tendencies if other stray circuit coupling effects are favorable to oscillation.

In constructing resistance or impedance-coupled audio amplifier stages, large inter-stage coupling condensers should not be employed in an attempt to extend low-frequency response. The heavy long time-constant condensers will set up a circuit condition wherein the audio amplifier stages will take off in a low-frequency "motor-boat" type of multi-vibrator square-wave oscillation which cannot be controlled.

For a given set of grid and plate load resistances or impedances, increasing the capacitance value of the coupling condensers beyond a certain maximum value results in little increase in low frequency response. Special low-frequency compensating circuits do this much more effectively. Resistance-coupled amplifier circuit component charts should be consulted for suitable coupling-condenser values.

Too many audio amplifier stages should be avoided in straight radio receivers. This will reduce audio circuit instability and achieve higher fidelity and a better signal-to-noise ratio. One driver is usually adequate to obtain full output from the power stage.

The oscillation problem is sometimes particularly troublesome when a new t.r.f. receiver is constructed, particularly where three stages are involved. Some of the usual methods applied to prevent excessive instability are: careful shielding of the r.f. coils, glass-envelope amplifier tubes, tuning condensers, by-pass condensers and r.f. chokes. Filter circuit isolation of the common plate and screen grid voltage supply and cathode chassis ground return circuits; separation of cathode bias resis-

tor circuits; omitting or adding some shielding in one or two of the amplifier stages; altering the by-pass condenser or inserting r.f. chokes in the cathode circuits of one or two of the r.f. stages are often more effective than shielding. Altering the plate or screen grid voltage supply circuits of one or two of the r.f. stages by changing the by-pass condensers or adding r.f. chokes or omitting isolating resistors; by concentrating the voltage supply bus leads of each stage at that stage; by concentrating the chassis ground return leads of each stage at that stage; altering the amplifier plate or grid load circuits of one or two stages by adding shunt networks of resistors and condensers

## WAR SURPLUS SALES

RADIO-ELECTRICAL-ELECTRONIC EQUIPMENT - PARTS - SUPPLIES

NEW Navy RBL 3 Low Frequency Radio Receiver

T.R.F. type receiver, with regenerative detector designed to cover 6 bands frequency range of 15 to 600 Kc; suitable for reception of voice, MCW, ICW, and CW signals. Operates on 115 v. 50-60 cycles AC. 7 Tubes supplied with set. Also metal box containing spare equipment—condensers, resistors, switches, tubes, replacement power transformer and other misc. items. Everything complete. Only **\$49.50**

WESTERN ELECTRIC Tungar converters; 110 volt AC to 24 volt DC; 5 amp. **19.95**

SIGNAL CORPS DRY RECTIFIER CONVERTERS; steps down AC input from 95v to 125v—50-60 cycles, to 24-36 V at 1.5 amps. **19.95**

SUPERIOR 2 KVA Power Stats; input 115 volt AC, 50-60 cycle single phase, output voltage range 0-135 volt; maximum rated output current 15 amp available over entire range of output voltage; weight approx. 20 lbs. **29.50**

SUPERIOR 2 KVA 3 1/2 KW power stats, 2 in tandem, each 115 volt AC single phase. Same as the above but twice the input and output voltage **54.50**

Crystals 5000 KC complete in holders **1.95**

Standard rack cabinets heavy gauge steel, gray crackle finish; panel opening 19" wide, 27" high **12.95**

PHILCO TANK ANTENNA—all aluminum, copper weld, dark grey finish; 12 feet long, in 3 sections; weight 10 oz.; base 5/16", dia. tip 1/8". Very special **\$.98**

Prompt Delivery  
25% deposit required on C.O.D. order  
Shipped F.O.B. New York. Minimum Order \$20.00.

**MICHAEL STAHL, INC.**

39 RCF VESEY ST.  
Tel. COrtland 7-5980 New York 7, N. Y.

## PREPAID ASSORTMENTS GUARANTEED FIRST QUALITY

100	1/3 Watt Resistors All Insulated	\$2.98
100	1/2 Watt Resistors All Insulated	3.98
100	1 Watt Resistors All Insulated	4.45
50	2 Watt Resistors All Insulated	3.98
50	200 Volt Paper condensers	2.98
50	Mica Condensers	2.98
20	Dry Electrolytic Filter Condensers	6.75
10	25 ft. Rolls Hookup Wire—Ass'd colors	1.95
10	Volume and Tone Controls—No Switches	1.98
100	ft. Spaghetti and Vinylite	.98
10	Coils I.F., R.F. Ant. and Osc.	3.98
20	Wafer and Ceramic Band Switches	3.98
50	Auto Suppressors	2.98
50	Electrical Wiring Devices, Plugs, Taps, Bases, Elements, Fuses, etc.	5.00

SEND FOR TRUTONE COMPLETE RADIO AND ELECTRICAL LIST  
Terms: 25% deposit required with order. Balance C.O.D. Merchandise sent prepaid if full remittance accompanies order.

**TRUTONE PRODUCTS CO.**

303 W. 42nd St. Dept. C New York 18, N. Y.



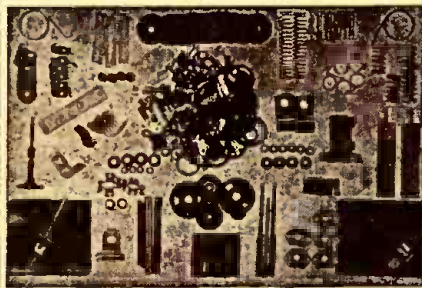

**2 1/2 POUNDS** GEARS • SHAFTS • BUSHINGS  
SPACERS • SPRINGS • RIVETS  
BRACKETS • CLAMPS • ETC.

**A-1 COMPLETE ASSORTMENT POSTPAID \$1.29**  
OUTSIDE OF U. S. A. ADD 50c

**GEORGE BROOKS & ASSOCIATES**  
220 SOUTH HALSTED STREET CHICAGO 6, ILLINOIS

**If It's a CANNON-BALL**



**It is a GOOD HEADSET**

For clarity of tone use Cannon - Ball sensitive phones. Assure dependable performance. Guaranteed to give absolute satisfaction. Write Headset Headquarters for folder R-2 illustrating complete line.

Scientifically Built Heavy bar magnets greatly increase their efficiency.

**C. F. CANNON COMPANY**  
SPRINGWATER, N. Y.

**ELECTRIFY your LAWNMOWER**

**Battery Operated! Self-Contained • Self-Propelled**

We show you how to convert your own lawnmower for use with a car battery. Save energy, labor and time with this self-propelled unit. Our simplified plans make it easy.



COMPLETE PLANS \$1

LEJAY MFG. CO., 256 Lejay Bldg., Minneapolis 8, Minn.

**BUILD 15 RADIOS**

**Absolutely No Knowledge of Radio Necessary—You Need No Additional Parts or Tools**

36 Page Book Written by Expert Radio Instructors. Teaches You to Build Radios in a Professional Manner.

You Will Start with a 1-Tube Receiver—Before You are Done With this Kit You Will Have Built 11 Receivers, 1 Public Address System and 3 Transmitters.

The **PROGRESSIVE RADIO KIT** is THE ONLY COMPLETE KIT—Contains Everything You Need!

Instruction Book, Metal Chassis, Tubes, Radio Parts, Soldering Iron, Pliers and Cutters, Screwdriver.

Price \$19.75

**PROGRESSIVE ELECTRONICS CO.**  
22 Havemeyer St., Brooklyn 11, N. Y.  
Gentlemen: Dept. 125RC  
Please send me the Progressive Radio Kit.  
 Check or Money Order Enclosed. Postage prepaid.  
 C.O.D. I will pay postage.  
NAME .....  
ADDRESS .....  
CITY ..... STATE .....

NOTE: Add 2% Sales Tax if in N.Y.C.

may be resorted to in stubborn cases. Rearranging the wiring, components and shielding; inserting r.f. filters in the power supply and filament supply leads; inserting series r.f. chokes between the voltage supply bus leads to each stage; increasing the minimum cathode resistor grid-bias voltage in each stage; reducing the plate and screen grid voltage supply to each stage; omitting one r.f. stage; may all have their uses.

It must be remembered that a circuit modification which should theoretically suppress or reduce circuit instability, may actually wind up in increasing rather than decreasing the trouble. This may occur when the complex inter-circuit stray coupling phase-relationships have been altered in such a way as to produce a net over-all in-phase positive feed-back regeneration effect. Thus the addition of isolation filtering, shielding, etc., may in certain cases, actually increase rather than suppress instability.

**WIDERANGE TESTER ERROR**

A mistake appeared in the diagram of the Widerange Pocket Tester, page 790, August, 1946. Mr. Pallatz writes:

In my recent article entitled "Widerange Pocket Tester" I erroneously stated that capacity measurements are made between "Minus" and "Cap." jacks. Actually the checks should be made between the jacks marked "Plus" and "Cap."

No damage can result from using the wrong terminals, but readings can be obtained only when the correct connections are made.

famous for

**GREAT VALUES**

**RADIO KITS**

**Five Tube Superheterodyne Kit**

Small Bakelite cabinet, size 9" x 5" x 6", complete parts (except wire and solder) for the construction of a standard superheterodyne receiver using 50L6, 35Z5, 12SA7, 12SQ7, and 128K7. All parts properly matched to chassis base. Price not including tubes ..... **\$10.75**

**Six Tube Two Band Superheterodyne Kit**

In a solid color wood cabinet (green, red), contains all parts (except wire and solder) to construct a high grade 2 band superheterodyne receiver covering regular broadcast and short wave bands. Tubes consisting of 2-6SK7, 1-6SQ7, 1-12SN7, and 25L6 included. Price ..... **\$17.75**

**Six Tube Superheterodyne Receiver**

Housed in an exceptionally artistic designed walnut cabinet. The engineering on this receiver is such as to provide good reception in the most critical locations. Built-in loop antenna of special design. Broadcast band 540 to 1620 KC. 30 Watts input. Price ..... **\$23.65**

**Intercommunication System**

A low priced two-way system for executives, professionals and home use. Consists of a master and one remote. Your Price ..... **\$17.25**  
Mallory line filter—useful in eliminating noises from offending electric appliances by installing the filter at source. Compares favorably with filters listing at \$10.00. Your cost ..... **\$3.45**  
Speaker repair kit (coldpatch). Eliminates the use of messy cement. Price.....each **\$7.75**

All prices are F.O.B. New York City.

Write for our new catalogue showing new test equipment, tubes and a large variety of new replacement parts. We ship anywhere promptly.

**RADIO DEALERS SUPPLY COMPANY**

135 LIBERTY ST., NEW YORK 6, N. Y.

**Phono-Bargains**

**1 TUBE PHONO OSCILLATOR \$3.95**  
uses 117N7 GT tube (less tube)

**WEBSTER "56" RECORD CHANGER \$26.66**  
automatically stops after last record is played.

**AC-DC PHONO-AMPLIFIERS**

completely wired  
1 TUBE uses 117L7 **\$2.06**  
2 TUBE uses 50L6 & 35Z5 **\$2.94**  
3 TUBE uses 50L6-12J5-35Z5 **\$3.53**  
4 TUBE uses 12SL7-35Z5-35L6-35L6 **\$5.29**  
(less tubes, speaker and volume control)

**PHONO MOTORS WITH TURNTABLES \$3.49**

**2 POST V.M. RECORD CHANGER \$17.95**  
3 for \$52.00

**PORTABLE PHONOGRAPH CASE**

Two-tone Leatherette finish dimensions 15 3/4" L x 14 3/4" W x 8" H **\$9.95**

**PORTABLE AUTOMATIC PHONOGRAPH RECORD-CHANGER CASE \$14.95**

**TEST EQUIPMENT**

**McMURDO-SILVER "VOMAX" \$59.85**  
volt-ohmmeter

**McMURDO MODEL 905 "SPARX" \$39.90**  
signal tracer

All items subject to prior sale  
20% with order, balance C.O.D. We prepay express on \$50.00 orders in U.S.A. Write for catalog

**Electronic Parts, Inc., Dept. C2**  
622 W. Randolph St., Chicago 6, Ill.

**JOBBERS-DEALERS**

**AND SERVICEMEN!**

**Your Tube Worries Are Over!**

**IF YOU NEED TUBES — WE'VE GOT 'EM!**

We seek your exclusive tube business. Send us a trial order (in quantity preferred). This will convince you we merit your patronage, based on low prices, quick delivery and guaranteed merchandise.

Only Radio Tubes is our business. The following is a sample of our bargains always in stock:

Type	Price	Type	Price
80 @.....	\$.38 ea.	7B6 @.....	\$.32 ea.
25Z5 @.....	50 ea.	7AF7 @.....	.32 ea.
12SA7 @.....	.51 ea.	1A7 @.....	.54 ea.
1U5 @.....	.39 ea.	IV @.....	.50 ea.
50B5 @.....	.44 ea.	5Y3GT @.....	.37 ea.
		1625 @.....	.19 ea.

SPECIAL 829 @ 2.50 ea.

**ALL OTHER TYPE TUBES IN STOCK AT SIMILAR LOW PRICES**

WRITE, WIRE OR PHONE FOR OUR SPECIAL PRICES

25% deposit on all orders, balance C.O.D., F.O.B. New York

**SENCO RADIO, Inc.,**  
(EXCLUSIVELY RADIO TUBES)

96 WARREN ST., N. Y. 7, N. Y.  
TEL. CORTLANDT 7-6065

**SPECIAL OFFER TO SERVICEMEN**

4 IN 1 COMBINATION SAVES YOU MORE THAN 25%  
1 pr. plastic radio pliers ..... \$1.50  
1 radio wrench set—3 socket sizes 1/4, 5/16, 3/8, 7/16, 1/2" ..... 1.25  
1 7/8" pc. Genuine Allen wrench set in leatherette case ..... .75  
1 Zoo flexible dashlite ..... 1.50  
Total Value **\$5.00**  
OUR SPECIAL PACKAGE PRICE **\$3.50**  
Each item may be purchased separately at above prices.  
**HOWARD SUPPLY CO.**  
490 Claremont Parkway, Dept. C, N. Y. 57, N. Y.



# AMSCO SPECIAL

● DE LUXE assortment consisting of transformers, switch box, switches, chokes, knobs, resistors, coil forms, tube sockets, panel light, insulators, terminal boards, condensers, relays, fuse holder, wire, volume controls, vibrators, neon lights, 1-2 1/4" speaker or Mike, etc.—Weight approx. 25 lbs.

(With every 5 kits, 1 kit free) **\$4.50** per kit

Write for our catalog.

**AMERICAN SALES CO.**

1811 W. 47th St.

Chicago 9, Ill.

## MEN MADE TO ORDER



**Fit Your Abilities To The Opportunities**  
You have unused talents and mental powers. Learn to develop those faculties of mind which today's world of business demands. Start life anew—without changing your affairs. Write the Rosicrucians for free Sealed Book telling how you may receive age-old teachings to achieve personal power.

Address: Scribe L.Z.H.

The ROSICRUCIANS, (Amorc) San Jose, Calif.

## RADIO TUBES

Most Critical Types in Stock 50L6, 1A7, 35Z5, etc.

Brand New, in Sealed Cartons

100% GUARANTEED

Repairmen and Dealers. Write For Available List at Trade Discounts

RADIO-EXPERTS

178 E. 33rd St., Dept. C, Paterson 4, N. J.

## ELECTRICIANS! RADIO MEN!

Earn More Money!

Get this new **GIANT SIZE**

**ELECTRICAL and RADIO TROUBLE SHOOTING MANUAL**

GUARANTEED BY COYNE

**Yours 10 Days Free**

OVER **500**

Large Size Electrical and Radio Shop Prints—How to read and use them

Needed by all workers, maintenance men, beginners, old timers! Nothing else like it. Saves time, helps boost your pay... 4 GREAT BOOKS IN ONE! 1. New Step-by-Step Trouble Shooting Course. 2. 500 Shop Prints. 3. Elec. Radio Dictionary. 4. Spare Time Jobs.

**FREE!** 1 yr. Technical Counsel by mail from COYNE staff, on trouble-shooting problems.

**SEND NO MONEY!** See offer below. Satisfaction guaranteed by famous COYNE "Learn-by-Doing" Electrical School. Rush coupon now!

H. C. LEWIS, President, Dept. 27-T1, **FREE TRIAL COUPON**  
COYNE ELECTRICAL SCHOOL  
500 S. Paulina St., Chicago 12, Ill.

Send postpaid Coyne's new Electrical and Radio Trouble Shooting Manual. In 10 days I'll either return it or send \$3, then \$3 monthly until total of \$7.50 is paid. [ ] Cash price \$6.95—you save over 55c. Same 10-day free trial and return privilege.

NAME \_\_\_\_\_ Age \_\_\_\_\_  
ADDRESS \_\_\_\_\_  
CITY \_\_\_\_\_ Zone \_\_\_\_\_ STATE \_\_\_\_\_

# NEW RADIO-ELECTRONIC PATENTS

By J. QUEEN

## CRYSTAL PRESELECTOR

Gleneth F. Collar and Richard C. Young  
Seattle, Wash.

Patent No. 2,405,999

This invention aids in eliminating interference due to atmospherics and from adjacent channel signals. It is especially useful where only a few frequencies are to be tuned in since two crystals are required for each incoming frequency.

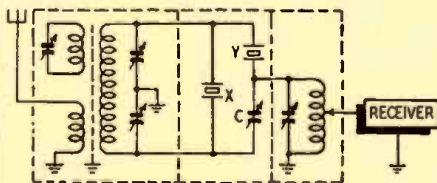

Ordinarily, a crystal filter is too sharply tuned to permit speech without distortion because of the high Q. In this circuit, an auxiliary circuit is added to reduce the Q as desired. The components are contained in a metal box with three shielded compartments. The first contains a wavetrapp and the antenna coil. The wavetrapp may be tuned to a persistently interfering signal. The second compartment contains the high-Q crystal circuit. X is resonant to an adjacent channel frequency and acts as a short-circuit to bypass the undesired signal. Y is ground for the desired frequency. The signal passes through it and through the auxiliary circuit in the third compartment. C is adjusted to equal the capacitance of the Y crystal holder. If current of other than the desired frequency flows through the holder capacitance, it is opposed by the current through C, and cancelled out.

The auxiliary tuned circuit is adjusted for resonance to the desired frequency. It is found that such a circuit loads the crystal circuit and reduces the Q. The coil is provided with a tap which varies the width of the response curve as required.

## ELECTRONIC CAPACITANCE

R. Lee Hollingsworth, Riverhead, N. Y.  
(Assignor to Radio Corporation of America)  
Patent No. 2,407,424

This invention discloses a new type of electron tube which is essentially a variable capacitance possessing no inertia. It seems to have many possibilities, an important one being a frequency modulator as described here.

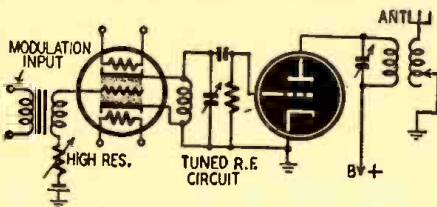

The tube contains a single grid with cathodes and filaments constructed symmetrically on either side. Electrons are emitted from each cathode to set up a space charge within the tube. The capacitance between cathodes varies with the intensity of the space charge. It is a minimum when no electrons are present between grid and cathodes, the dielectric constant then being equal to that of empty space.

The tube is connected across a tuned circuit (or a quartz crystal). The modulation input changes the grid potential at an audio rate, thus causing a change in the tube capacitance and therefore carrier frequency at the same rate. To produce single side-band modulation it is only necessary to suitably bias the grid so that it can vary only in a negative (or only a positive) direction.

## TRIGGER CIRCUIT

Arthur J. Ruhl, Washington, D. C.  
Patent No. 2,405,237

This is a simple circuit which can generate square waves in synchronism with input pulses.

The triodes may be separate tubes or halves of a twin-triode type.

Because of its connection to the positive terminal of the power supply, the second grid is normally positive and current flows in the plate circuit. Current through the bias resistor causes the first tube to be cut off. When a negative pulse is applied between B and ground, the first grid goes positive and current flows in the plate circuit. The pulse in the latter circuit is transferred through the coupling condenser to the second grid, cutting off this tube and causing a sudden rise in plate voltage which is transferred to the output circuit.

The condenser and resistor in the second grid circuit are so chosen that the negative charge is maintained on the grid for a desired interval. The resistor may be adjustable as shown in order to vary the width of the square wave. When the charge leaks off, current flow in the second plate circuit, again biasing the first tube to cutoff. The circuit is then ready for the next pulse.

If the input pulses are positive, they are applied to terminal A instead of B.

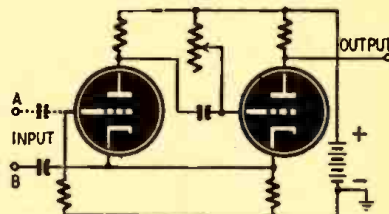

## FREQUENCY METER

Robert D. Schwartz, Devon, and William West Moe and Lowell J. Hartley, Bridgeport  
(Assignors to General Electric Co.)  
Patent No. 2,137,859

Although several types of frequency meters are available, there is need for a simple circuit which is easily adjusted and which can measure over a wide range. This new circuit uses only two tubes: a power pentode and a double-diode tube.

The input voltage may vary over a wide range, for example, 25-150 volts. It is required that the negative peaks cause plate current cutoff and that the positive peaks result in grid current. A resistor R<sub>1</sub> is placed in the grid circuit to prevent excessive current flow by producing the necessary grid bias. Depending upon the instantaneous polarity of the input frequency, therefore, the pentode operates either at cut-off or at maximum plate current. In the first case there is no voltage drop across R<sub>2</sub>, and in the second case the voltage drop across it is practically equal to that of the plate battery. As a result, the condenser C<sub>1</sub> charges and discharges periodically. The charging current must flow through D<sub>1</sub> and therefore does not affect the microammeter. The discharge current, however, does cause deflection since it must pass through D<sub>1</sub>.

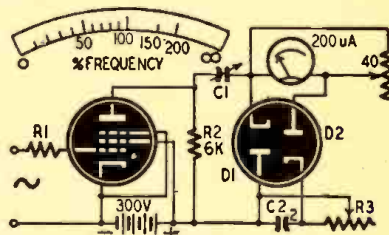

If the condenser discharge were complete each time the meter would indicate in direct proportion to the input frequency and might be damaged if a very high frequency were impressed. The discharge is limited by C<sub>2</sub>, however, and at high frequencies the meter reading tends to become constant (see typical meter scale).

The main frequency determining elements are C<sub>1</sub> and R<sub>2</sub>. Typical circuit values for two frequencies are as follows:

Mid-scale frequency	R <sub>2</sub>	C <sub>1</sub>
110 cycles	20K	10μf
1 mc	30K	.05μf



# THE RADIO PEN IN EUROPE

IN EVERY April issue of RADIO-CRAFT, for many years past, its editor has endeavored to have a little fun with his readers. To this effect he usually cooks up an electronic hoax, which he disguises in such plausible terms that the project looks real. Many an innocent reader, no longer astonished at the latest electronic miracles, may get caught in this scientific hokuspokus. That is, unless he plows through the entire article and reads to the very end where he finds the words "April 1st." He may then have a good laugh at his own expense, or cuss the editor roundly. Trouble is that most readers do not read the entire article; thus a goodly percentage take the article at its full face value.

The interesting part of the joke is, that none of the projects which are published every April are impossible! They are not only feasible, but usually in a decade or more they will become

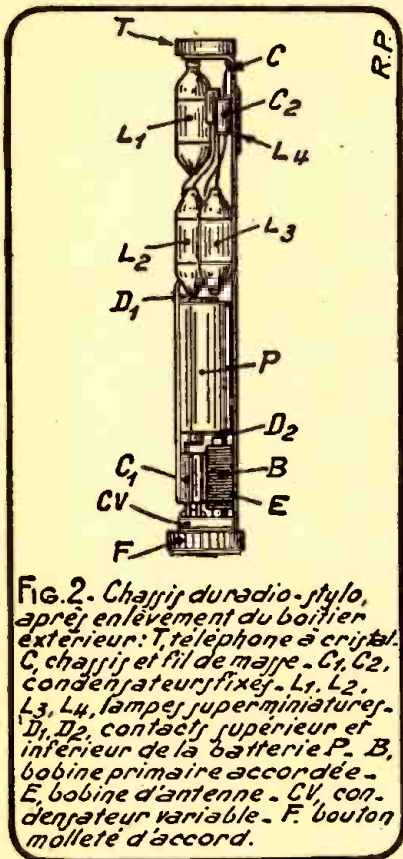

Fig. 2. Chassis du radio-stylo, après enlèvement du boîtier extérieur: T, téléphone à cristal. C, chassis et fil de mèche. C<sub>1</sub>, C<sub>2</sub>, condensateurs fixes. L<sub>1</sub>, L<sub>2</sub>, L<sub>3</sub>, L<sub>4</sub>, lâmpes superminiatures. D<sub>1</sub>, D<sub>2</sub>, contacts supérieurs et inférieurs de la batterie. P, B, bobine primaire accordée. E, bobine d'antenne. CV, condensateur variable. F, bouton molleté d'accord.

realities. Yet for the time being each remains just an April Fool hoax.

The Radio Pen in the April, 1946, issue was no exception to this. RADIO-CRAFT received the usual quota of letters from readers who wanted to get more information where they could buy either the complete pen or some of the components, etc. But the Radio Pen proved an exception to the usual run of former, similar April jokes, in that a serious technical magazine swallowed the whole article hook, line, and sinker.

In their Juné, 1946, issue the French technical radio magazine *La Radio Professionnelle*, of Paris, republished the

entire article as a new American invention, without, however, giving any hint that it was a hoax!

This led to quite a few repercussions in France when a number of other French technical magazines let loose an Olympian roar of laughter at the expense of their discomfitted publisher confrère. Said the French *Toute La Radio* in their July-August issue:

"It happened that a French journalist has taken the article seriously. In a professional radio magazine he dedicated a very elaborate article to the description of the 'Fountain Pen' receiver (but omitted to mention the source of his information). Gernsback surely never expected such a repercussion of his joke. For our part we found that the subject gives rise to gratifying reflections intermixed with sweet moments of hilarity."

Another French radio magazine of Paris, *Le Haut Parleur* (The Loud Speaker) comments as follows, in a page-long article, translating the original American text:

"The four-tube Radio Pen is in reality a good joke. Unfortunately, this was not realized by a French confrère, who hadn't read the article to the end. He coolly proceeded to reprint a full description in a recent issue of his journal.

"We ourselves reprint the fantasy-article just for a bit of amusement. After all, perhaps we deal here only with a simple anticipation."

That, however, was only the beginning. It appears that dire international complications due to the Radio Fountain Pen are in the offing. In their issue of October 2, 1946, *Le Travailleur Alpin* (communist newspaper) of Southern France, expostulates:

"A nice little story!"

A 4-TUBE RECEIVER IN A FOUNTAIN PEN.

"Such is the promising title in the American Magazine RADIO-CRAFT, which gave full details and a description of this new 'Marvel.'"

"This was also the title of an article in a French magazine informing its readers of the sensational invention without mentioning that this formidable 'Fountain Pen' was nothing but an amusing April Joke!

"RADIO-CRAFT was, of course, dated April 1, and the end of the article showed that it was only an April Joke (French 'An April Fish')."

"Our French Fellow-Journalist had not seen this and he was the April Fool. (In French: He swallowed the Fish)."

"But let us not be too much astonished about this. Doesn't the American propaganda try every day to hook us with such jokes? Accepted in a more than favorable manner by certain (French) newspapers, it showers us ceaselessly with news items, one more sensational than the next. The sense of criticism of more than one reader is being sapped. Some heads have been so deeply penetrated by the conviction that

(Continued on page 80)

## SENSATIONAL CLEARANCE of WAR SURPLUS EQUIPMENT at a Fraction of Its Original Cost

We offer hundreds of "hard-to-get" items in amateur radio supplies along with the best in "HAM" equipment—all at a great saving to YOU.

Our stock includes a wide assortment of:

- Plate Transformers, Chokes, Relays
- Filter conds., Trimmers, Padders, Cables
- Tubes, Transmitting & Receiving Conds.
- Coax Cables, Fittings, Wire, Crystals
- Switches, Sockets, Dials, Plugs, Dynamotors
- Test Equipment Coils, Chokes, Power Supplies
- Receivers, Transmitters, Rectifiers, Amplifiers
- Hundreds of other items

Our latest bulletin is just off the press giving complete descriptions, specifications and bargain prices. Get your copy of BULLETIN 1 RC today.

We also carry standard lines as: Cardwell, B&W, Shure, Temco, Westline, I.C.A., Workshop Associates, Waterproof Elec. Co., Telegraph Apparatus, Atlas, S/C Labs and others. Catalogs on request.

NIAGARA RADIO SUPPLY CORP.  
160 Greenwich St., New York 6, N. Y.

Please send me a copy of your latest BULLETIN 1 RC, listing hundreds of "hard-to-get" radio supplies, and place my name on file for future mailing.

Name .....

Address .....

City ..... Zone ..... State .....

Immediate Delivery On All Items

NIAGARA RADIO SUPPLY  
160 Greenwich St., New York 6, N. Y.  
Bowling Green 9-7993

**ARMY-NAVY HEAD PHONES**  
**\$2.49**

B-A made a lucky buy. Genuine U. S. Signal Corps head phones, 8000 ohms impedance, highly sensitive, 8000 ohms magnets. Only \$2.49 a pair plus 20c postage and pkg. chgs. Retail value \$13.50. Order No. 17A37.

FREE Catalog

GET THIS catalog, latest developments in radio and electronic parts and devices, newest ham gear, gadgets and bargains.

BURSTEIN-APPLEBEE CO.  
1012 McGee St., Kansas City 6, Mo.

Send me your new FREE catalog.

Send me \_\_\_\_\_ pairs of phones at \$2.49 plus 20c pair postage. I enclose \$ \_\_\_\_\_ in payment. RC

NAME \_\_\_\_\_

ADDRESS \_\_\_\_\_

TOWN \_\_\_\_\_

STATE \_\_\_\_\_

## SPECIAL

While 1000 kits last. 10 lb.

Radio Parts Assortment **\$1.69**

AMERICAN SALES CO.  
1811 W. 47th St. Chicago 9, Ill.



# WILCOX CW 3 RECEIVER



The CW Receiver is a highly selective crystal controlled superheterodyne unit operating of any fixed frequency in the band of 1900 kc to 16,500 kc. The total band is covered by means of four groups of plug-in coils. Extension of the range above or below the specified range may be had by means of special groups of plug-in coils. Plug connections are provided for 110 volt, 60 cycle AC power source and for connection of receiver output.

- ★ FIXED FREQUENCY RECEIVER
- ★ 7 TUBE SUPERHET CIRCUIT
- ★ CRYSTAL CONTROLLED LOCAL OSCILLATOR
- ★ COILS SUPPLIED COVER 5.6 TO 10 MEGACYCLE BAND
- ★ AUDIO AMPLIFIER STAGE CAPABLE OF PRODUCING ZERO LEVEL DB OUTPUT ACROSS A 500 OHM LOAD
- ★ TUBE COMPLEMENT
  - 2-6K7
  - 1-6K8
  - 2-6C8G
  - 1-6SN7
  - 1-80
- ★ COMPLETE SET OF EXTRA SPARE TUBES
- ★ FITS STANDARD 19" RACK, 19" WIDE, 3 1/2" HIGH, 11 1/2" DEEP
- ★ GRAY & BLACK FINISH
- ★ PACKED IN WOODEN SHIPPING CASE
- ★ WEIGHT ONLY 14 LBS. NET
- ★ SHIPPING WEIGHT 42 LBS.
- ★ COMPLETE WITH INSTRUCTION BOOK, COILS, LESS CRYSTAL

ONLY \$21<sup>95</sup>

F.O.B. N.Y.

25% deposit required  
on C.O.D. shipments

**MARITIME SWITCHBOARD**

336 CANAL STREET NEW YORK 13, N. Y.

## TELEVISION FOR TODAY

(Continued from page 31)

each pulse to set the level of the bias which will prevail during the associated line of image detail. Thus, by having the tube's grid bias vary directly with each line, we can reinsert the d.c. component.

Note that the bias does not vary from instant to instant, but only at each pulse. Throughout the remainder of the line it is steady, affecting each video variation in an identical manner. In this way we do not erase the detail within the line. Values of  $R_g$  range from 400,000 ohms to 1 megohm;  $C_c$  is then chosen accordingly.

From the plate of the final amplifier the adjusted signal is applied to the control grid of the cathode-ray tube. No intervening condensers are employed, since these would only remove the d.c. that has just been inserted. Because of the direct connection, it is necessary to place a positive voltage on the cathode of the image tube to counteract the positive voltage at the control grid.

An additional control must be provided at the image tube so that the blanking pulses of the incoming signal coincide with the beam cut-off of the tube. A potentiometer (generally labeled *Brilliance Control*) is placed in the cathode lead. With it, the observer is able to adjust the cathode-ray tube bias so that no retrace is visible on the screen.

Some commercial receivers obtain d.c. reinsertion by adding a diode tube. See Fig. 4. The final video stage now is operated as a conventional amplifier.

The amplified signal is coupled to the grid of the cathode-ray tube. At the same time a portion of the signal (that appearing across the 3,300-ohm resistor) is applied through a 10,000-ohm resistor and a 0.005  $\mu$ f condenser to a diode tube. The d.c. voltage is produced

here and inserted into the video signal through the 470,000-ohm resistor.

To respond to only the negative synchronizing pulses, the diode tube must be inverted. The plate will then reach its most positive value (with respect to its cathode) at the synchronizing pulses. As the pulse reaches its greatest amplitude, the voltage difference between the ends of  $R_2$  reaches its greatest value, with the top end negative. This potential is applied directly across  $R_3$ ,  $C_1$ , and  $R_1$ . Because of the diode, the 1-megohm resistor is effectively bypassed at this instant and condenser  $C_1$  is charged to its greatest value. Throughout the remainder of the video line, until the next pulse, the diode tube is inoperative while the accumulated charge across  $C_1$  discharges through the 1-megohm, the 3,300-ohm, and the 10,000-ohm resistors. The flow of electrons is up through  $R_1$ , making the grounded and negative with respect to the other terminal of the resistor. The amount of charge on  $C_1$  varies from line to line, being governed wholly by each synchronizing pulse. The voltage will fluctuate as described for the previous method.

Since the d.c. reinsertion occurs beyond the final video amplifier, it is permissible to insert a coupling condenser between the 1852 and the control grid of the cathode-ray tube. However, there is no coupling condenser after the d.c. reinsertion. The presence of the 0.1  $\mu$ f coupling condenser removes the previously high positive voltage from the control grid of the image tube and permits a smaller biasing voltage at the cathode.

### Image Synchronization

While the video information is being supplied to the grid of the image tube, some directed voltage must be activat-

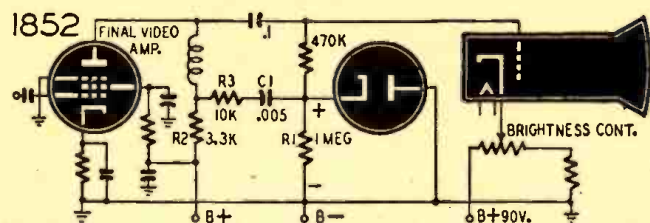

Fig. 4—This method of d.c. reinsertion uses an additional diode tube.

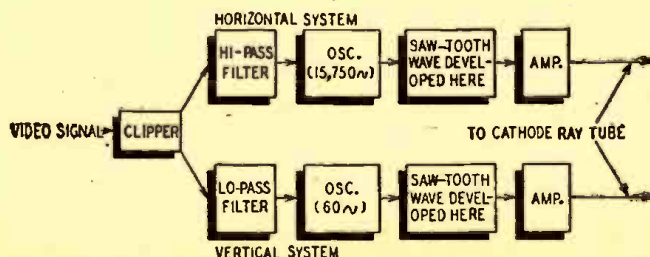

Fig. 5—Block diagram of typical deflection and synchronization system.



ing the deflecting coils to position the video signals in their proper place on the screen. This is the function of the synchronizing pulses.

There are two types of synchronizing pulses in a video signal, the vertical and the horizontal. Since all pulses have the same amplitude, their separation necessarily must be based upon their frequency difference. Horizontal pulses have a fundamental frequency of 15,750 cycles per second; vertical pulses appear every 1/60 second. In addition to their separation, it must be remembered that at no time should either synchronizing system be permitted to slip out of control.

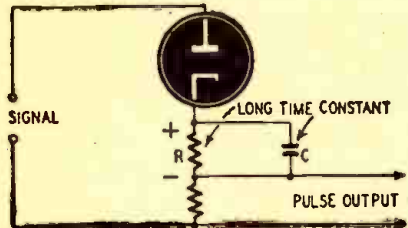

Fig. 6-a—Fundamental diode clipper circuit.

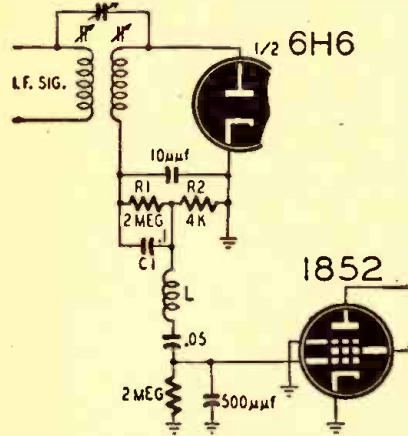

Fig. 6-B—The above as applied commercially.

A block diagram of the entire synchronizing system of a typical television receiver is given in Fig. 5. At some point beyond the video detector, a portion of the video signal is applied to a clipper tube which separates the pulses from the rest of the signal. Vertical and horizontal pulses are separated by means of low-pass and high-pass filters. Other names for these units are *integrating* and *differentiating* networks, from the similarity of their actions to the same processes in mathematical equations.

The pulses obtained from the filters trigger their respective synchronizing oscillators, locking them in to the pulse frequency. If the two are close in frequency, the lock-in will be sufficiently binding to prevent the oscillator from returning to its free-running state. The synchronizing oscillator controls the charge and discharge of the saw-tooth voltage generator. A saw-tooth wave, applied to the deflecting plates or coils, will place the image properly on the screen. The purpose of the *clipper* is to separate the synchronizing pulse from the rest of the video signal. In operation, then, it must remain unresponsive to any voltage other than the pulses.

(Continued on page 74)

## Four Reasons Why

# RADIO SERVICEMEN PREFER WRIGHT VERIFIED SPEAKERS

BRIGHTENING  
Tone Quality

STURDY  
Construction

CONES  
Stay Centered

THE VERIFIED GUARANTEE PROTECTS THEM  
Against Any Loss

## WRIGHT INC.

2233 UNIVERSITY AVE.

ST. PAUL 4, MINN.

## MORE SMASH BUYS at National Radio Distributors

NOW! IMMEDIATE DELIVERY!

THE NEW AND IMPROVED NATIONAL RADIO AND PHONO KITS. The original and still the finest. All parts brand new and unconditionally guaranteed against defect. No War Wreary Surplus. Component parts are perfectly matched for easy wiring and topnotch performance. These kits also feature new Alnico V speakers. Beautiful Plastic Cabinet. Built-in loop Antenna. Dust-Proof backs, and illuminated Airplane dials. Instructions include clearly drawn, easy to follow schematic diagrams.

MODEL N. R. 7-5 TUBE 105-125 A.C./D. C. SUPER-HETERODYNE. Uses 12 SA7, 12SK7, 12SQ7, 50L6 & 35Z5 Tubes. Net Price \$11.95 Lots of 3 " " " 10.95 Kit of 4 Matched Tubes " " " 4.50

MODEL N. R. 8-5 TUBE TWO BAND A.C./D.C. SUPER HETERODYNE, as above. Freq. Range: Band 1-850 to 1600 K.C. Band 2-5.5 to 18 Megacycles. Net Price \$13.95 Lots of 3 " " " 12.95 Kit of 5 Matched Tubes " " " 4.50

MODEL N. R. 1-4 TUBE A.C./D.C. 105-125 T.R.F. Uses 12 SK7, 12 SJ7, 50L6 & 35Z5 Tubes. Recommended for Students, Schools, Hospitals and Institutions. Net Price \$10.95 Kit of 4 Matched Tubes " " " 3.50

MODEL P. R. 7-Portable Radio-Phonograph COMBINATION KIT. Features: Powerful 5-Tube Superheterodyne radio, Sec N. R. 7 Self Starting Phono Motor, Feather-Weight Crystal Pick-Up Arm Luxurious leatherette covered carrying case. Will play 10" & 12" records with lid closed. Net Price \$27.50 Kit of 5 Matched Tubes Net Price \$4.50

NEW VANITY PORTABLE ELECTRIC PHONOGRAPH, completely assembled, ready to plug into 110 V.A.C. line.

- As small as a Ladies' Vanity-Case Measures 12" x 10" x 3 1/2"
- 5" Alnico V. speaker, concealed underneath turntable.
- Full 1 1/2 Watt Beam Power Output, with Tone & Volume Control.
- Luxurious Two-Tone leatherette covered carrying case. Will play 10" & 12" records.

List price \$34.50 Your Net \$22.95 Please Remit at least 25% with order. We will ship balance C.O.D. We carry complete stocks of Supreme, Precision, Duo-tone Bright Star, Webster, Stancor, Merit, etc. WRITE FOR COMPLETE CATALOG. IT'S FREE! Cable address, "ENARDEE," New York

## National Radio Distributors

899 Southern Blvd., New York 59, N. Y.

Radios for the hard-of-hearing are now being made by a national manufacturer. The radios have, in addition to the regular loudspeaker, a molded plastic ear-piece with individual volume control adjustable to the listener's needs.

## ANNOUNCING--

The first volume in the long-awaited Massachusetts Institute of Technology Radiation Laboratory Series, bringing you—

the engineering data you need  
to design RADAR SYSTEMS



Here is an important book which presents the general principles of the design of various radar systems. From the standpoint of the designer the book discusses the basic considerations which underlie and are particular to systems design.

## RADAR SYSTEM ENGINEERING

Edited by L. N. RIDENOUR, Associate Professor of Physics, University of Pennsylvania. Over 900 pages, 6x9, \$7.50.

AFTER a general approach to Problems encountered, this authoritative book takes up the leading design considerations for the important components that make up a radar set. Detailed examples of actual systems are included. Two new and important auxiliary techniques—moving target indication and the transmission of radar displays to a remote indicator by radio means—are fully treated. Anyone interested in the varied applications of radar will find this new volume of immense value as a basic, useful reference.

10 days' free examination—mail coupon

Mc-Graw-Hill Book Co., 330 W. 42nd St., N.Y. 18. Send me M.I.T. Radiation Laboratory Series, Vol. 1—Radar System Engineering for 10 days' examination on approval. In 10 days I will send you \$7.50 plus few cents postage\* or return book postpaid. (We pay postage on cash orders.)

Name .....

Address .....

City and State .....

Company .....

Position .....



# "TAB"

That's A Buy

Transformer cased "LANGEVIN" Pri 105 to 250V/60cy Sec 2240VCT/500ma. 12V/4.5A, 19.2/2.5A, 2.5V/10A \$11.50. Two for \$19.95  
 1000 cycle hummer DC Inpt-Freq. adjust. .97  
 Transformer 50/800cy/80&115V. Sec 1000 VCT-300V 110ma. 6.3V/4.5A, 5V/3A to 3V/.65A. 6.3V/.65A. 6.3V/1.25A & 2 H'cased chokes 10H/110ma & Two 3mf/330VAC/1000WVDC oil condrs & 1641/RK60 Heat tube & socket. .95  
 Transformer 840VCT/110ma. 530VCT/21ma. 5V/3A, 5V/3A. 6.3V/1A, 8.3V/1A, 115V/60 cyPri & Two 10H/110ma chokes & oil Condr 2/2.5mf&5mf/600WVDC & Rack chassis. 6.95  
 H'cally cased chokes 10H/115ma/185ohm. Two for 2.50

IF YOU DON'T SEE IT — WRITE FOR IT  
 ASK FOR CATALOGUE 99  
 New Navy SP 3" Synchroscope Complete \$59.50

S.C. Remote control unit RC201 Complete. \$24.49  
 S.C. Tuning Unit BC-746A & 2 crystals 1.00  
 Ext cord 10 foot hvy duty 5J with Male & Female plugs 1.00  
 WE Dynamic Microphone D-1733-4D-A with 50' cable 9.95  
 Kenyon dynamic mike 1.00  
 Collins choke 6H/1.2amp/12500V wkg Cased Micro-Mu Switch leaf SPDT 15A/125V. Two for 1.08  
 Transf line to line 500, 333, 250, 200, 125, 50 ohms 1DB 1.95  
 West's Receptor F.W. res. trans. 8V/1.5A amp Headsets HS10A-S.C. new S.C. Inap with 6' cord 1.95  
 W. E. 508 Headset & 8 ft Cord & Plug (S12) 4.95

G.R. VARIAC 200CU/860W/Oto130V/60cy & Dial. Knob \$14.95  
 G.R. VARIAC 200B/170W/Oto130V/60cy & Knob 9.95  
 Sola LAB model Constant Voltage Transf 60Watt/95-125V 15.00

Condr 10mf/600WVDC oil (2-2.5mf&5mf) \$1.25  
 Condr 20mf/600WVDC oil (1-2-4-5-8mf) 2.50  
 Condr 2mf/5000WVDC oil (LP#45) \$6.75  
 Two for 12.00  
 Condr Pyranol 3 mfd/330VAC/1000WVDC Two for 2.50  
 Condr Pyranol 15mf/330VAC/1000WVDC 4.50  
 Condr RF 25mmfd/10000V wkg new 3 for .75  
 Condr CD oil 8mf/1500WVDC 2 for 4.50  
 Condr GE Pyranol 4 section 2.5mf/660 VAC/2000WVDC 7.95  
 WE uncer min PP/P to PP/C Inpt. RS9029 1.20  
 WE PP Inpt & PP res. trans. 8V/1.5A amp 6.95  
 UTC uncer dynamic mike to grid .49  
 Uncer choke HI-Impedance Jefferson .49

PRECISION WIRE WOUND 1% RESISTORS, INC. SMALLCROSS. MFC. INST. REG. CO. OHMITE FOR METERS, BRIDGE AMPLIFIERS  
 \*1%, \*\*5%, \*\*\*10%  
 1500 2000\* 4000 4300\*\*  
 5000 7500\* 10000 15000  
 17000 30000\* 75000 100000  
 140000 147000 190750 201000  
 22000 25000\* 65000\*\* \*REST  
 "TAB" SPECIAL 3 for \$1.00 (1%)  
 250000 294000 314000 333500  
 300000 400000 420000 422000  
 485000 478000 THREE for \$1.50  
 500000 700000 THREE for \$1.95  
 1 Megohm 1% accy THREE for \$2.45

Dynamotors 12V Inpt/275V/110ma \$1.95  
 Dynamotors 500V/50ma Conv. rated & filter & 275V unit 3.49  
 Weston 478 SQ 3" B.C. 15VAC (S10) 4.25  
 Weston GE 1048DB 500/600ohm L. 3.95  
 Weston 301 meter 10KV/1000ohms V & Mult 15.00  
 WESTON 796 insulation tester & Microhm-meter in oak case-new. 5.50V & 10 meg 24.95  
 Electronic VM 13meg section 5.50V & 10 meg 24.60  
 SC A27 Phantom Antenna new with manual Contains Millen 12.51 Variable Condr 150mmf/3000V & 2 WL plaque 12ohm/40 Dynamic mlke & min transf to G new 1.95  
 Dynamic mlke & min transf to G new 1.95

CRYSTALS MTD "BT" CUT Four for... \$3.00  
 DC-15A Standards 200KC ± 10cy 5.85  
 CINCH MICA B Dual crystal sockets. 8 for 1.00

WE Crystals boxed IN21-22-23 3 for \$1.25  
 WE Crystal boxed sealed IN26 LUHF/1cm ea .54  
 ICR Precision 1KV/1meg 4.95  
 sealed Navy (S25) 1.69  
 WSTGHE DIAL AN IND 200 microamp 4.50  
 GE Meter 2 1/2" B.C. one amp RF 3.95  
 GE Meter 2 1/2" B.C. five amp RF 3.50  
 GE & De-Ju 2 1/2" B.C. one ma DC intr. 2.95  
 Socket Octal 785B mica B (18c) 1.50  
 25 for 1.50  
 Socket Octal MIP 88-8X (20c) 20 for 1.50  
 Socket Octal ceramic 49558 (45c) 15 for 1.50  
 Socket Octal ceramic & saddle rlnK Cinch 10 for 1.50  
 Socket marginal ceramic 49-SS1L (1.25) 2 for .98

866A GE Comb. tubes, fil transf, caps, sockets \$7.00  
 872A Comb tubes, fil transf, caps, sockets 12.00  
 808 RCA tubes new gtd S.C. BOXED Two for 5.00

Socket miniature bayonet DialCO 93-4931. 100 each \$ .15  
 Socket Hubbel 15A/125V Twist lock 7586 Five for 2.00  
 OSCILLOSCOPE 5" inc. Inlet transducer 115V/80cyPri. 375VCT/110ma 1320V 5V/3A. 2.5V/3.25A. 6.3V/2.75A AC200V Ray tube, Rectifier tube, Condens. Chokes Low&H.V. Supply. 16.95  
 Pri transf inp 230V/sec117/112/103/93V at 7mil 19.95  
 Auto Trans GE 115V/100/170/200V/1.95A Littifuses 250ml/3AG (I.P. 25c) 48 for 2.00  
 Condenser kit silvermica & mica condrs 50 for 2.00  
 Resistor kit BT 1/2 & 1Watt 50 to 2megohm asstd resistors 2.50  
 Control kit AB: 50 to 2megohm: Ten for 2.50

\$2 Min. order FOB N.Y.C. Add Postage all orders and 25% deposit. Worth 2-7230. Send for catalogue 390. Specialists in International, Export, School, College & Industrial trade. Money Back Guarantee.

"TAB" DEPT. RC2  
 6-A CHURCH STREET, NEW YORK 6, N. Y.

## TELEVISION FOR TODAY

(Continued from page 73)

Perhaps the simplest way of achieving this is to permit the pulse itself to serve as the biasing agent. In Fig. 6-a, the diode clipper uses the time constant of R and C to bias the tube so that all save the synchronizing pulses are eliminated. Condenser C and the resistor R form a low-pass filter with a relatively long time constant, equal to approximately 10 horizontal lines. Therefore, the voltage developed across R (and C) will be determined by the highest voltage applied across the input terminals. This, of course, means the synchronizing pulses. Throughout the remainder of the line, while the video voltage is active, the plate is never driven sufficiently positive to overcome the positive cathode bias.

A commercial application is shown in Fig. 6-b. One half a 6H6 is used for picture signal detection (not shown) while the other half is devoted entirely to combined pulse rectification and clipping. R1 and R2 form the pulse detector load. Here the rectified signal is developed. The time constant of the load is set essentially by C1 and R1. At the application of each pulse to the tube, a short flow of current takes place, recharging C1, and, at the same time, causing the pulse to appear across R2. This voltage is passed on to an 1852 synchronizing pulse amplifier. The series inductance L maintains the response of this network to the higher frequency components of the square-shaped pulses.

Note that the circuit in Fig. 6-b employs a separate diode for pulse rectification and clipping, and in addition a separate amplifier. A simpler arrangement would have resulted if the clipping did not occur until after the first video amplifier. In this way, the additional amplifier would have been unnecessary.

The chief disadvantage of a diode clipper is the loss in amplitude that results. With a triode or a pentode connected as a pulse clipper, we gain some amplification plus a sharper sep-

aration between signal and pulse. Typical circuits are shown in Fig. 7. Each tube is zero-biased in the absence of a signal. When a signal is applied, current flows, charging the coupling condenser. Throughout the remaining portions of the cycle, when grid current is not drawn, Cc discharges through Rg. The result is grid-leak bias. Since this form of bias is determined by the most positive portion of the signal, it works very well in producing sufficient bias to serve as a clipper. To aid clear-cut separation, lowered tube potentials are utilized.

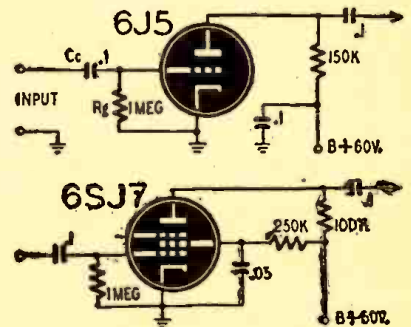

Fig. 7—Triode and pentode types of clippers.

It should be noted that the foregoing triode and pentode clipper stages are essentially similar in form to the d.c. insertion network of Fig. 3. Their difference, however, lies in the values of the grid resistors, and the electrode operating potentials. In the clipper, Rg is high, generally 1 megohm or more. Further, the operating voltages are low. In the d.c. reinsertion circuit, Rg is much lower in value and the tube voltages are higher. The high grid resistor of the clipper biases the tube to the point where only the pulses cause plate current. The lowered plate voltage aids this action. In the d.c. insertion circuit, the negative bias is less, permitting current to flow throughout the entire video signal. In both instances, however, it is the synchronizing pulse portion of the signal which is effective in setting the bias.

## DETECTOR FOR THE OSCILLOSCOPE

NEARLY every service shop of respectable size now has an oscilloscope. This is a very handy instrument, with a multitude of uses. A few additions can increase its uses to cover many other things. Most oscilloscopes respond to only a limited range of frequencies, generally not over 100 kc. This range is sufficient for many uses but if you desire to use it as a signal tracer, the higher frequency r.f. is only a blur on the 'scope. By inserting a detector before the amplifier in the 'scope you can trace a modulated signal from antenna post to the speaker. By adding a phone jack or a small 4-inch speaker the signals can

be heard as well as seen. This speeds services greatly and many troublesome problems can be solved in a jiffy with this efficient instrument. The detector can be constructed and installed in three or four hours for less than five dollars.

The exact location on the chassis of the detector will vary with the make of the 'scope. I found it best to put the tube on a separate little chassis of its own—approximately one and one-half by two and one-half inches in size—and bolt it directly to the top of the 'scope chassis. The detector should be close to the amplifier already in the 'scope.

An infinite-impedance detector was



**Order from LAKE!**  
**You'll Make No Mistake!**  
**RADIO Cabinets & Parts**

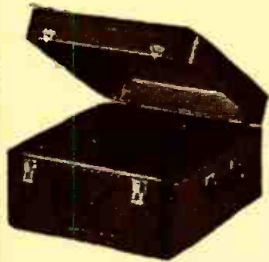

**De Luxe  
PHONO  
CABINET**

Covered in luxurious, genuine brown leatherette, has deluxe brass hardware throughout, made completely of plywood with brown plastic handle, has padded top and bottom. Motor board

14" x 14 1/2". Overall dimensions 16" L x 15" W. x 8" H. Your net price..... **\$8.95**

**DE LUXE RECORD-CHANGER and  
AMPLIFIER CASE**

De luxe changer case with ample room for amplifier. Overall dimensions 20" L x 10" W. x 10" H. Sturdily built of 3/4" plywood, de luxe brass hardware throughout. Inside dimensions: 15 1/2" L x 14 1/4" W. x 9 1/2" H. **\$12.95**

Also blank table cabinets of walnut veneer in the following sizes, with speaker opening on left front side. (Note: 7" has center speaker grill.)

#1	8 1/2" L x 5 1/2" H x 4" D	\$1.95
#2	10 1/2" L x 6 1/2" H x 5" D	\$2.75
#3	13 1/2" L x 7 1/2" H x 6 1/2" D	\$3.25
#7	10 3/4" L x 7" H x 5 1/2" D	\$2.50

\*Speaker Opening in center of front side.

**SERVICEMEN-RETAILERS**

Join our customer list today. Write today for our new 16-page illustrated catalog NR-116. It's free. Get on our mailing list. Dept. C

**LAKE RADIO SALES CO.**

615 W. Randolph Street, Chicago 6, Ill.

**The  
HOUSE OF A  
MILLION RADIO PARTS**

**POPULAR KITS  
FOR SERVICE AND SOUND MEN**

- 60S 6 Assorted Speakers Cones 5-6 & 8" ..... \$2.49
- 50K Assortment of 50 bakelite knobs push on ..... 3.95
- 100K Assortment of 100 knobs—bakelite—wood—push on and set screw ..... 6.72
- 101R Assortment 100—1 watt, 1/2 watt and 1/4 watt Carbon Resistors.. 2.94
- 200R Assortment 200 1/4 watt insulated resistors ..... 4.95
- 69K Heavy Duty Army Code Key .... .69
- 10C Heavy Duty 10 tube Power Transformer ..... 2.95

Thousands of other bargains available for immediate shipment. Catalog on request.

**Lifetime Sound Equipment Co.**

DEPT. 26 TOLEDD 2. OHIO

**Do you need  
BINDING POSTS?**



The XL PUSH POST with its Spring Action assures Constant Contact and quick connection. Manufactured in All Aluminum Type M at 12c each. Aluminum Body, Bakelite Top Type S1 at 15c each. Types GP or NP. ALL BRASS—STAINLESS STEEL SPRING & PIN. PROVEN BY 240 HR. SALT SPRAY TEST as NON-CORROSIVE at 25c each. Manufacturers and Dealers Liberal Discounts

**X. L. RADIO LABORATORIES**

420 West Chicago Ave., Chicago 10, Ill.

Low-temperature dry cells, developed by the Bureau of Standards during the war, operate excellently at 22 degrees below zero, and can be used at 40 below. One of the new cells is a methyamine hydrochloride-ammonium chloride type, the other works with calcium chloride and ammonium chloride. The latter battery was the more successful, and is adaptable to many commercial uses.

found to work the best of all circuits tried. This was followed by a straight amplifier to increase the gain on weak signals. To save space a 6SN7 (twin triode) tube was used as the combined detector-amplifier. It was found to give good gain in the amplifier ( $\mu=20$ ). The infinite-impedance detector will work well on either large or small input signals. Most important is that it does not overload the circuit to which it is coupled. It also has low distortion—an important fact when a circuit is being tested for fidelity. Care should be taken in constructing this circuit so no distortion will be introduced by it.

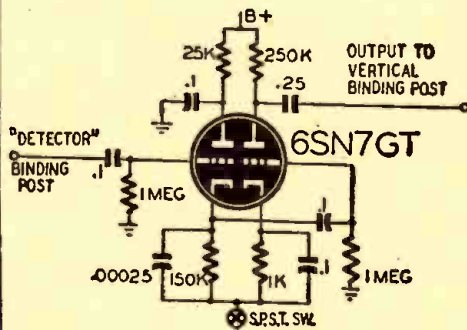

Circuit of the detector and amplifier stage.

The figure shows the circuit and method of hookup. An extra binding post should be installed on the front of the oscilloscope for the input and can be labeled "detector." A 0.1  $\mu$ f condenser couples the detector grid to this binding post. The cathode of the detector is bypassed only to r.f. but the plate is bypassed to both r.f. and a.f. by a 0.1  $\mu$ f condenser between plate and ground. The output of the detector is coupled to the grid of the amplifier through a 0.1  $\mu$ f condenser. The output of the amplifier should be connected through a 0.25  $\mu$ f condenser to the vertical input binding post which is already coupled to the vertical amplifier in the scope. The detector circuit is turned on or off by a switch which grounds or ungrounds both the detector and amplifier cathodes. B+ for the plates is obtained from any handy suitable high voltage point under the chassis and the filament is connected in parallel with the other 6.3 volt filaments. An open-circuit jack can be installed on the front panel for the 'phones. The jack can be coupled through a .05  $\mu$ f condenser to the common side of the vertical amplifier on-off switch—this is usually on the vertical gain control. The scope is now ready for use and with the phones plugged in any modulated r.f. signal fed into the "detector" binding post will be heard as well as seen. Seeing as well as hearing aids greatly in service work—distortion can readily be seen on the 'scope as well as heard in the 'phones. With the detector off it in no way affects the operation of the oscilloscope.

The small amount of work and the small cost, to the service man, of adding this circuit will be repaid many many times over by the ease and speed with which he can now repair those really "tough" jobs. The service man will find countless new uses for his oscilloscope. —Kenneth C. Dike

**OSCILLOSCOPE  
FOUNDATION KIT**

5 INCH

Consisting of Case, Chassis, two shelves (right & left), tube shield and bracket, front panel, screen window frame, handle, plastic window socket, with 5CP1 Cathode Ray tube—Special ....



**\$15.50**

- 2x2 Tube ..... \$1.00
- Socket for 2x2 Tube ..... .25
- H.V. Condenser .5 Mfd 2000 V- 1.95
- KIT, without Cathode Ray tube 11.95
- Tube shield and bracket only.... 1.98

**SURPLUS TUBES  
at BARGAIN PRICES**

All Tubes New and Sold Under New Tube Guarantee



5CP1	-3.95	884	-.99	6J5GT	-.51
5BP1	-4.95	885	-1.05	6L6C	-1.20
5BP4	-4.95	8012	-1.25	6L7	-.99
5JP1	-9.95	15E	-1.25	6SD7	-.65
3BP1	-3.45	15R	-1.25	6SH7	-.65
954	-.89	E-1148	-.69	6SL7	-.89
9002	-.89	2C26	-1.30	6SN7	-.69
1619	-.89	EF-50	-.79	12SK7	-.80
1625	-.70	VR 105	-.99	6 X 4	-.69
1629	-.89	2050	-1.30	6Y6G	-.89
1631	-.99	7193	-.99	12A6	-.99
1633	-.89	UH50	-3.95	12C8	-.79
1644	-.99	10Y	-.99	12SN7	-.79
2C40	-2.30	5R4GY	-.99	37	-.49
2C43	-4.25	864	-.60	1G6	-.87
3C45	-1.40	6X5	-.89	1J6	-.87
100TH	-8.25	843	-2.75	12SQ7	-1.05
2051	-1.35	811	-2.00	34	-.80
801A	-2.05	6F8	-.92	30	-.80
802	-2.05	6SJ7	-.74	83	-.92
803	-7.95	75	-.70	6K7	-.79
805	-5.25	70L7	-1.65	104	-.79
813	-7.50	1R5	-.79	6B8C	-.79
826	-4.25	2X2A	-1.05	6AC7	-.99
6SQ7	-.80	3A4	-.79	6AC7	-.84
1616	-.99	3Q4	-.89	39.44	-.60
717A	-1.05	6AB7	-.84	5Y4	-.63
713A	-.85	6AB5	-1.05	5Y3	-.63
371A	-1.29	6AK5	-1.30	6K6	-.69
1960	-.75	6AL5	-.89	6W7	-.79
836	-1.75	6C4	-.64	12 SF7	-.69
837	-2.10	6C5	-.59	6SK7	-.79
866	-1.25	6C5	-.59	6SK7	-.79
865	-1.05	6H6CT	-.56	6J7	-.80

Minimum Order on Tubes \$2.00

All Prices FOB New York City, N. Y.

Send for Our FREE Monthly Bulletin

**Highbridge Radio-Television  
and Appliance Co.**

340 CANAL STREET NEW YORK 13, N. Y.



# COMMUNICATIONS

ALWAYS ONE INTERESTING ARTICLE

**WIRE! WIRE! WIRE!**  
**U. S. Army Wire W-110-B**  
 5500 ft. Double Strand  
 Per ft. . . . . \$33.00  
 Coil Deposit Returnable. 6.00

**RGU 8 Low Loss Cable—**  
 Radio Frequency about  
 1200' to a coil. . . \$0.41/2 ft.

**Radio & Communication**  
**Wire 7/32" Copper**  
**Shielded—Brown rubber**  
**—Covering about**  
**5000'—Coils . . \$3.50 1000'**

**AN 16 Aircraft Wire**  
 Also AN 14 **\$3.50 1000'**  
*White and other colors*

**LYELL HARDWARE CO.**  
 P. O. BOX 5 ROCHESTER 11, N. Y.

**AMAZING NEW RADIO!**  
**Pocket or Purse size**  
 SMALL AS A PACK OF CIGARETTES! Weighs only a few ounces—Beautiful black chrome plastic case. Uses new war born crystal diode, Hi-Q-slide dial, NO tubes, batteries or electric "plug-ins." Usually receives local broadcasts without outside aerial wires.

**GUARANTEED TO PLAY**  
 when used according to instructions sent with each radio! You can use it at home, in offices, hotels, cabins, in bed, etc.—lots of fun—real entertainment!

**Send Only \$100** (cash, money order, check) and pay postman \$2.99 plus delivery fees on arrival or send \$3.99 for postpaid delivery. Complete as shown Ready to Play with self contained personal photo. For Gift—children will love it—grown-ups too! An exceptional value—order yours and enjoy the many good radio programs coming! Don't be without your Pa-Kette Radio another day! (All foreign orders \$5.00 U.S. cash.)  
 Pa-Kette Electric Co. Dept. RC-2 Kearney, Nebraska

**PEN-OSCIL-LITE**  
 Extremely convenient test oscillator for all radio servicing; alignment • Small as a pen • Self powered • Range from 700 cycles audio to over 800 megacycles u.f. • Output from zero to 125 m.w. • Low in cost • Used by Signal Corps • Write for information.

**GENERAL TEST EQUIPMENT**  
 38 Argyle Ave. Buffalo 9, N. Y.

**ELECTRONIC VOLT-OHM-METER**  
**\$1185** 110 VOLTS AC 20 RANGES  
 0/5/10/50/100/500/1000/5000 volts DC and AC. 0—1,000,000,000 ohms in six overlapping ranges. Sensitivity: over MILLION OHMS per VOLT on 5 volt range.

POSTPAID Complete kit includes all component parts, tubes, punched and drilled chassis and beautifully enameled panel. Easily assembled and wired.

Special slideback circuit developed during war by scientist at the California Institute of Technology gives amazing sensitivity and flexibility while completely eliminating necessity of batteries and expensive meter. Each instrument is individually calibrated. Dial scale over nine inches long!

In addition to performing the usual volt-ohm functions, this instrument easily measures these voltages: SUPER-HET OSCILLATOR, AVC, AFC, TRUE GRID BIAS AT THE GRID, BIAS CELLS without affecting the circuit. Measures the exact leakage resistance of INSULATION, TUBES, CONDENSERS. It can be used with a signal generator for SIGNAL TRACING.

**STERLING ELECTRONIC COMPANY**  
 168 N. Sierra Bonita Ave., Dept. 2, Pasadena 4, Calif.

**YOUR ELECTRIC DRILL**  
**Has 100 Other Uses**  
 when used with K-Jax attachments  
**METAL SAWING . . . SHEARING**  
**RIVETING ATTACHMENTS**  
 Ask your Hardware dealer or write for illustrated circular  
**K-JAX, 2600 Canton St., Dallas, Texas**

British trains are experimenting with radar to cut down time lost in fog. The work is being carried on cooperatively by the country's four largest railroads, and radar-equipped trains are already making test runs.

Dear Editor:

I think RADIO-CRAFT is one of the great magazines; there is always at least one article of interest in it. Take for instance articles like that one on the 'Scope in October, that keen article on Improving Sound Equipment in November, and—for a change—the December story on W2IXY was very good.

I get a kick out of reading the Communications Dept, or the Complaint Department, as it sometimes seems to be. I think some of these correspondents are like the gal who married the poor guy to improve him, instead of improving themselves, which is why I read RADIO-CRAFT (from Volume I, No. 1). I don't expect RADIO-CRAFT to be a

**SERVICEMEN SHOULD SELL**

Dear Editor:

As a new hand at the game, I have the following to offer on the question: "Why does a radio (service) man want to sell sets?"

I opened up shop this year (1946) with the sole idea of service and service only. After turning out 600 sets in three months, I want more than ever to sell radios!

Each salesman has his particular item or product to sell. Also he knows the game and is a qualified (not an "authorized") man in his particular field. A good baker knows bread; a good furniture man knows furniture. Why should not a good radio man know radio?

But here's the story I hear every day from set owners: "When I bought that console, I thought I was buying a good radio. Instead I bought a good box." This is true. If the customer wants a good shortwave radio, the furniture man sells him a large console. A radio man would recommend a communications set, something the furniture man, druggist or other "radio dealer" never heard of!

More than once, after I had picked up a big box, the customer has come in while I had the "works" on the bench, and refused to believe that the midget chassis was his radio. They buy their sets on a basis of: "The bigger the box, the better the receiver," and feel swindled when they see "that little thing on the bench." You can explain to them that the big box acts as a baffle and improves reproduction but they still feel (correctly) that a "bigger and better" radio would be even more of a help to get a better output.

It takes a radio man to sell radios. As one radio man to all you others, I say: "Let's stop the 'box' racket and sell the public radios, the kind of radios they need and require!"

OTIS H. WYMAN,  
 Collinsville, Ill.

pure service magazine, and for that reason I take *Service, Radio Service Dealer, Radio & Appliance Journal* and *Radio Maintenance*. I don't expect it to talk nothing but Ham lingo, and for that reason the newsdealer sells me *QST*, the *Ham Bible (ARRL Handbook)* and *CQ*.

I believe that RADIO-CRAFT is in a class of its own—a good solid, middle-of-the-road radio and electronics magazine, and by the beard of the Prophet, may it always be thus!

V. H. HERNDON,  
 Odon, Indiana.

(While RADIO-CRAFT is pleased and happy to receive letters like the above, please keep on sending your kicks to our "Complaint Department."—Editor)

Come to the famous  
**COYNE**  
**TRAINING SHOPS**  
 where you learn by doing



**TRAIN FOR RADIO-ELECTRONICS**  
 IN A FEW WEEKS

**Prepare For A Good Job Now With A Lifetime Future!**

Trained Radio-Electronics men needed now. They will be needed too in the years to come. Don't be caught napping. Get a Radio training now and be ready. Learn by Doing. Free employment service for life after graduation. Many gain while learning. If you are short of money, ask about my Student Finance Plan. Now added Training in Industrial Electronics and Electric Refrigeration. We are also equipped to train those who qualify under G. I. Bill. We also have facilities for men with physical disabilities whether due to war or other causes. Fill in and mail coupon for details.

**SEND COUPON FOR FULL DETAILS**

B. W. COOKE, Dir., Radio-Electronics Div.  
 COYNE ELECTRICAL SCHOOL  
 500 S. Paulina St., Dept. 27-8E, Chicago 12, ILL.  
 Send Big Free Book; also details about Coyne Part-Time Employment and Student Finance Plan.  
 Send G. I. Bulletin  Physical Disability

NAME..... AGE.....  
 ADDRESS.....  
 CITY..... STATE.....

a GOLD MINE of  
**SURPLUS PARTS**  
 for RADIO REPAIRMEN  
 AMATEURS AND EXPERIMENTERS

**12 lbs. of RADIO PARTS only \$2.00**

Relays — Condensers — Resistors  
 Transformers — Coils — Hardware  
 Wire, etc., etc.

Send 2.00 cash, check or M.O., today! (Pay small express charges on receipt.) Write for Radio Parts Catalog.

**ELECTRONIC PARTS, Inc.**  
 622 W. Randolph St. Dept. C2 Chicago 6, Ill.



## SMALL RECORDING STUDIO

(Continued from page 52)

plifier consists of two input circuits arranged as a mixer, so that individual gain control of each circuit is possible. The mixer is followed by two voltage amplifier stages and a push-pull triode output amplifier. Negative feedback is applied to the cathode circuit of the first voltage amplifier stage. See Fig. 2.

Filter networks are so inserted in the feedback net that the low- and high-frequency response may be varied independently. Note the method of connecting the mixer plate circuits so that the loading of the tubes on each other is negligible. The speaker and monitor phones are driven from the output transformer, which is of the high-fidelity type. The crystal cutter is driven through a pair of 2- $\mu$ f condensers directly from the plates of the 6B4G's. To reduce the hum level to the vanishing point, all the heaters except the 6B4G's are supplied from a 6-volt d.c. source. This d.c. is obtained from a selenium rectifier through a heater filter circuit consisting of a filament transformer and two 1000- $\mu$ f filter condensers.

The amplifier gain is approximately 100 db which is adequate for all but the lowest level microphones. A pre-amplifier is used when additional gain is necessary.

The amplifier is mounted in the cabinet, with a sloping metal panel added to mount the recording controls. These include the two gain controls, together with their input selectors. One input is used for AM, FM recording, and playback from either the Brush pickup or the dynamic pickup, mounted on the auxiliary 12-inch Presto turntable. The other input is used for microphone work and can be switched from a remote mike to a local one so that the recordist may make necessary announcements.

The next control group includes the bass compensation control, the high-frequency selector and the high-frequency compensation control. There is a wide choice of high frequency boost points which allow compensation of the high loss in recording toward the center at

33 1/3 revolutions per minute. The response can be varied to provide the proper conditions for recording FM, AM, voice, and for any special effects required.

The last group of controls includes the cutter switches and power switches. One switch applies the amplifier output alternately to a playback speaker or the cutter. There is another to give either a constant-velocity or constant-amplitude cutting characteristic. The main power switch and motor power switch complete the group.

Located conveniently are the jacks for the local microphone and the earphones. A 0-1 milliammeter is mounted in the top surface of the cabinet to indicate cutting level and is plainly marked as to the maximum cutting level. A 1N34 germanium crystal diode is used as the meter rectifier, as its frequency response is absolutely flat over the audible range and far beyond.

All the external connections to the cabinet are made by means of a terminal plate which includes the radio, mike, and remote pickup inputs, speaker output, 117-v input, and filament and plate voltages for the four-stage t.r.f. AM tuner. All the wiring from amplifier to panel and terminal plate is completely shielded to reduce hum pick-up. With the gain controls wide open and the bass boost control in the maximum position, the hum is inaudible. There is no pattern on the recordings from motor vibration or from any other source, and the rumble of the turntable is below the scratch level of a professional quality recording disc which has been cut with a new sapphire.

The speaker system consists of a Jensen 14-inch auditorium type L woofer and a Jensen type C tweeter mounted in a home-made bass reflex baffle. A photograph of this speaker appeared in the November (1946) issue of RADIO-CRAFT, in which it was described completely.

In the next installment of this series, Mr. Hoadley will tell how to make a record. Succeeding articles will deal with electrical considerations, recording troubles and other features of sound recording.

## A RADIO KIT OF NOTABLE QUALITY AND VALUE!



Our model R-3 is a 3-tube receiver kit of the regenerative type. This receiver is the 110 volt type and operates at a frequency of 550

Kc to 1500 Kc by means of a plug in coil. The power supply is self-contained in the receiver thus eliminating the need for a separate power pack. This kit comes to you completely disassembled.

### ALSO AVAILABLE

KIT MODEL S-55 . . . a 5-tube superheterodyne radio kit, comes complete including tubes, bakelite cabinet and instructions, ready for assembly.

KIT MODEL S6X . . . a 6-tube, 2-band receiver kit, equipped for either 110 or 220 volts, AC or DC . . . covers the following ranges: 550 Kc- 1600 Kc, 4-16 Mc. This kit is furnished complete, ready for assembly.

KIT MODEL RP-S5 . . . a combination radio and phono kit. (5-tube superheterodyne radio), 5" Alnico V Speaker, Astatic L-72 pick-up, beautiful walnut finish cabinet, ready for assembly.

(ALL KITS SUPPLIED LESS WIRE & SOLDER)

Write for Descriptive Catalog M

## RADIO KITS COMPANY

120 Cedar St., New York 6, N. Y.

## BE YOUR OWN BOSS!

### MAKE MORE MONEY



\$1.00 VALUE

25c

40,000 WORDS IN TEXT

In "CASH IN" you now get THE real money-makers — dozens of profitable tested mail order plans, confidential business secrets, dozens of practical tested formulas, successful tested schemes — actual experiences of men who have started on a shoestring—with less than \$10 capital. 25c a copy postpaid. Send U. S. stamps, money order, or coin.

Money Back Guarantee

NATIONAL PLANS COMPANY

Box 26RF, Ansonia Station

New York 23, N. Y.

# THE BIGGEST BARGAIN ON EARTH!



One of the best Vacuum tube Volt-Ohm-Milliammeters ever built. For only \$44.85. (Built to sell for \$52.50) (Used on atom Bomb) Furthermore—10 days' FREE TRIAL.

0-1000 in six ranges DC and AC 6% in. probe. Flat response from 20 cycles to over 20 kcs. 0-200 meter 4 1/2 inch scale. Reads direct, no

graphs to follow, uses 6SN7—6H6—6X5—Black crackle case 10 x 8 x 7 made by St. Clair Engineering Corporation.

Send money in advance and if not satisfied in ten days return meter and get your full amount refunded less postage. 20% deposit if ordered C.O.D.

Take it! . . . Try it! . . . Test it!

## RADIO EQUIPMENT COMPANY

377 EAST MAIN STREET

LEXINGTON, KENTUCKY





# SCARCE TUBES

GOOD DISCOUNTS  
ON ALL TUBES

7B6, 7C6, 7G7, 58, 1D8, 2A6, 12K7, 14Q7, 1L84, 1LC6, 5Z4, 788, 7C5, 84, 12Z3, 1LA6, 43, 47, 25Z5, 32L7, 57, 12A8, 6F5, 50Y6, 35Z3, 35, 6Q7, 0Z4, 117Z6, 7A8, 70L7, 7B7, 6A8, 50A5, 2A5, 59, 1LN5, 14R7, 7C6, etc.

All Tubes New and Guaranteed.

Write for Catalog—We Ship Anywhere.

**COMMERCIAL RADIO**  
36 BRATTLE ST., BOSTON 8, MASS.

## THE YEAR'S BIGGEST OFFER

### 10 lb. Radio Parts Assortment

A "find" for the radio serviceman. Hundreds of valuable radio parts, including coils, resistors, trimmer condensers, lugs, transformers, switches, hardware, etc.

Only ..... \$1.95

Write for radio parts circular

**RANDOLPH RADIO STORES**  
609 W. Randolph St. Chicago 6, Ill.

### SERVICE MEN!

- RCA Radiotron
- Sylvania
- Tungsol
- Raytheon

Tubes, Parts & Equipment  
Write for our latest bulletin, Dept. C2

Distributors of  RADIO EQUIPMENT

## CHIEF ELECTRONICS

104 MAIN STREET, POUGHKEEPSIE, N. Y.  
The Square Deal Supply House

## OPPORTUNITY AD-LETS

Advertisements in this section cost 20 cents a word for each insertion. Name, address and initials must be included at the above rate. Cash should accompany all classified advertisements unless placed by an accredited advertising agency. No advertisement for less than ten words accepted. Ten percent discount six issues, twenty percent for twelve issues. Objectionable or misleading advertisements not accepted. Advertisements for March, 1947, issue must reach us not later than January 29, 1947.  
Radio-Craft • 25 W. Broadway • New York 7, N. Y.

**CORRESPONDENCE COURSES AND SELF-INSTRUCTION** books, slightly used. Sold. Rented. Exchanged. All subjects. Satisfaction guaranteed. Cash paid for used courses. Complete information and 100-page illustrated bargain catalog Free! Write—Nelson Co., Dept. 39, Chicago 5, Ill.

**WE REPAIR ALL TYPES OF ELECTRICAL INSTRUMENTS,** tube checkers and analyzers. Hazleton Instrument Co. (Electric Meter Laboratory), 140 Liberty Street, New York, N. Y. Telephone—BArcley 7-4239.

**MAGAZINES (BACK DATED)—FOREIGN, DOMESTIC,** arts, books, booklets, subscriptions, pin-ups, etc. Catalog 10¢ (refunded). Ciccone's, 863 First Ave., New York 17, N. Y.

**AMATEUR RADIO LICENSES, COMPLETE CODE** and theory preparation for passing amateur radio examinations. Home study and resident courses. American Radio Institute, 101 West 63rd Street, New York City. See our ad on page 80.

**FREE WHOLESALE BULLETIN, TUBES, PARTS,** Bargain prices. Henshaw Radio Supply, 3313 Delavan City, Kansas City, Kansas.

**WANTED COPIES OF "MODERN ELECTRICS" AND** "Electrical Experimenter." State Price. Box GT, % Radio-Craft.

**"WIRE RECORDER HEAD—RECORDS, REPRODUCES,** erases. Highest quality laboratory instrument. Brush made for Government. Value \$12.50. Our price \$2.50 with order. Radloco 1110R Marshall Bldg., Cleveland, Ohio."

**ALL RIDER MANUALS WANTED. WRITE, LOPES,** 780 E. 214, New York City.

**BARGAIN—CONDENSER KITS 15 ASS'T. MICAS** .00005 to .001—250-500 V \$1.00. Reliable Radio, P.O. Box 132, Merchantville, N. J.

## INDEX TO ADVERTISERS

Allied Radio Corp.	48	National Radio Institute	1
George Brodsky Advertising		Van Sant, Dugdale & Co.	
Almo Radio Co.	60	National Schools	13
E. L. Brown Co.		The Mayers Co.	
American Sales Co.	70, 71	National Union Radio Corp.	2
Amplifier Corporation of America	65	Hutchins Advertising Co.	
Sternfield-Godley, Inc.		New York Technical Institute of N. J.	42, 43
Audel Publishers	58	Schwab & Beatty, Inc.	
Grant & Wadsworth		Newark Electric Co., Inc.	6
Bell Telephone Labs.	Inside Back Cover	The Charles Brunelle Co.	
N. W. Ayer & Son		Niagara Radio Supply	71
Brooks, George & Associates	69	Burke & Wayburne Advertising Agency	
The Schram Advertising Co.		Oelrich Publications	68
Buffalo Radio Supply	57	Sander Rodkin Advertising Agency	
International Advertising Agency		Olson Radio Warehouse	45
Burstein-Applebee Co.	71	Jessop Advertising Company	
Frank E. Whalen Advertising Co.		Opportunity Adlets	78
C. F. Cannon Co.	69	Pa-Kette Radio Co.	76
M. J. Werner Adv.		Arrow Advertising Agency	
Capitol Radio Eng. Inst.	49	Progressive Electronics Co.	69
Henry J. Kaufman & Associates		Radcraft Publications	63
Chief Electronics	78	Radio Dealers' Supply Co.	69
Graphic Company of Advertising		Burke & Wayburne Advertising Agency	
Cleveland Institute of Radio Electronics	47, 55	Radio Electric Service Co.	40
Kenneth Kolpein		David Zibman Adv.	
Commercial Radio	78	Radio Equipment Co.	77
Goulston Co., Inc.		Radio-Experts	70
Communications Equipment Co.	12	Radio Kits Co.	77
Borough Advertising Co.		Hamburger Agency	
Concord Radio Corp.	46	Radio Parts Co.	51
E. H. Brown Advertising Agency		Sydney S. Lovitt Adv.	
Coyne Electrical School	59, 70	Radio Publications	64
Phil Gordon Advertising Agency		Radolek Company	67
Coyne Electrical School	76	Turner Co.	
McJunkin Advertising Agency		Randolph Radio Stores	78
Crabtree Wholesale Radio	79	Reed Manufacturing Co.	79
DeForest's Training Institute	11	Rosticrusians, The	70
Lauesen & Salomon		Richard Jorgensen	
Dow Radio	79		
Electronic Parts, Inc.	69, 76		
Campbell & Reynolds			
Esse Radio Co.	14, 15		
Gary A. Ruben Advertising			
Feller Engineering Co.	60		
George Brodsky Advertising			
General Cement Mfg. Co.	51		
Sander Rodkin Advertising Agency			
General Electronic Distributing Co.	54		
Bass & Webber Co., Inc.			
General Test Equipment Co.	76		
Suzanne Hayman Adv.			
Harrison Radio Co.	53		
Altomari Advertising Agency			
Hershel Radio Co.	8		
Hugh Allen Advertising			
Highbridge Radio-Television and App. Co.	75		
Burke and Wayburne Advertising Agency			
Hollander Radio Supply Co.	67		
Turner Advertising Agency			
Howard Supply Co.	69		
Hudson Specialties	64		
Instructograph Co.	79		
Turner Advertising Agency			
International Resistance Company	41		
John Falkner Arndt & Co., Inc.			
K-Jax	76		
Lafayette Radio	52		
Reiss Advertising Agency			
Lake Radio Sales Co.	75		
Sander Rodkin Advertising Agency			
Leads Radio Co.	64		
Bass & Webber Co., Inc.			
LeJay Mfg. Co.	69		
Frizzell Advertising Agency			
Leotone Radio Corp.	59		
Altomari Advertising Agency			
Liberty Sales Co.	62		
Sternfield-Godfrey, Inc.			
Lifetime Sound Equipment Co.	75		
The Miller Agency			
Lyell Hardware Co.	76		
McGraw-Hill Book Company	73		
McMurdo Silver Co., Inc.	54, 65		
Edward Owen & Co.			
Mallory & Co., P.R.	Back Cover		
Aitkin-Kynett Company			
Maritime Switchboard	72		
Metropolitan Electronic & Inst. Co.	56		
Bass & Webber Co., Inc.			
Murray Hill Books, Inc.	4, 5		
Harry P. Bridge Advertising Agency			
National Plans Institute	77		
National Radio Distributors	73		
Burke & Wayburne Advertising Agency			

RADIO SCHOOL DIRECTORY—See Page 80

American Radio Institute		Sams & Co., Inc., Howard W.	3
Sternfield-Godley, Inc.		Aitken-Kynett Co.	
Baltimore Technical Institute		Senco Radio, Inc.	69
Benson Radio Institute		Simpson Electric Co.	Inside Front Cover
Gunn-Mears Advertising Agency		Kreicker & Meloan, Inc.	
Candler System Co.		Sprague Products Co.	16
Rand-Ries Adv., Inc.		Harry P. Bridge Co.	
Commercial Radio Institute		Sprayberry Academy of Radio	9
Lincoln Engineering School		Harry P. Bridge Co.	
Buchanan-Thomas Adv.		Stahl, Michael	68
Malville Radio Institute		Bass & Webber Co., Inc.	
Seidell Adv.		Standard Electronic Dist. Co.	79
RCA Institutes		Sterling Electronic Co.	76
United Radio Television		Superior Instruments Corp.	39
Western Radio Television Institute		Bass & Webber Co., Inc.	
Y.M.C.A.		Supreme Publications	61
		Henry H. Teplitz, Advertising	
		Sylvania Electric Products, Inc.	7
		Newell-Emmett Co.	
		"TAB" Technical Apparatus Bldrs.	74
		Bass & Webber Co., Inc.	
		Trutone Products Co.	68
		Julius J. Rowen Company	
		Turner Company	44
		W. D. Lyon Co.	
		Variety Electric Co.	66
		Bass & Webber Co., Inc.	
		Wright, Inc.	73
		Kay Advertising Agency	
		XL Radio Laboratories	75

### CARBON ARC SOLDERING

I find that good soldering carbons can be made from the arc carbons used in movie projectors. These carbons are copper sheathed and the leads may be soldered directly to this coating.

The negative carbon is preferable because it burns down to a sharp point. Used carbons may be obtained from the projection room of almost any movie theatre.

N. SCHREDMAN,  
Bronx, N. Y.

### SCRATCH REMOVER

Plastic materials such as flash-light lenses and radio dials often become scratched and soon take on the appearance of ground glass. The scratches may be removed by buffing the surface with a piece of soft felt that has been coated with a film of jeweler's rouge. Glass also may be polished by this method, but the process is a long and tedious one.

HARRY A. NICKERSON,  
Dorchester, Mass.



# BOOK REVIEWS

**RADIO FAMILIES—U.S.A.** Compiled and published by the Broadcast Measurement Bureau. Flexible fiber covers, spiral wire binding, 8½ by 11 inches, 250 pages (publisher's statement, pages not numbered). Price \$5.00.

A compilation of the number of families owning radios in each county in the United States, this book is divided into three sections. The first compares the total number of families with the number of radio families in each county in the United States, and is divided by states. The second indexes all cities of 10,000 or more population, plus all cities of under 10,000 which have a radio station. List is alphabetical by city. The third section shows the population and radio population of metropolitan districts.

A Canadian supplement shows radio ownership by counties, or by census subdivisions where counties do not exist.

Percentages are given in all cases, and show that radio ownership ranges from 91.1 in one county in Massachusetts through 50 percent in an Alabama county to 34.3 in one county of Quebec. Although all figures were secured by statistical methods and therefore do not reflect local variations from the general pattern, the overall picture given by these percentages should be very useful not only to the radio advertiser but to the general businessman surveying economic and cultural conditions in any of the areas covered by the report.

**RADAR, WHAT IT IS**, by John F. Rider and G. C. Baxter Rowe. Published by John F. Rider Publisher, Inc. Flexible paper covers, 8½ x 11 inches, 72 pages. Price \$1.00.

This simply written and well-illustrated book is prepared for the layman or student with no previous knowledge of radio or electronic fundamentals—nor is this knowledge required—for the work gives a fairly complete picture of radar that can be understood by elementary students without resorting to mathematics or physics.

Its eight chapters, illustrated with photographs, diagrams, and clever cartoons, utilize simple analogies to explain the fundamentals, development, and applications of radar. Because of the simple presentation, this book will provide interesting reading for the scientifically minded layman.

**ELECTRIC MOTOR REPAIR**, by Robert Rosenberg. Published by Murray Hill Books, Inc. Flexible fiber covers, 6½ x 9 inches, special binding, 308 pages of text and 243 separate pages of illustrations. Price \$5.00.

This book, which can serve equally well as a text, laboratory workbook, or handbook on electrical motor repair, will be useful to motor repairmen as well as students and vocational instructors.

Step-by-step servicing and troubleshooting procedure is presented on all types and sizes of a.c. and d.c. motors.  
(Continued on page 80)

## EASY TO LEARN CODE

It is easy to learn or increase speed with an Instructograph Code Teacher. Affords the quickest and most practical method yet developed. For beginners or advanced students. Available to persons from beginner's alphabet to typical messages on all subjects. Speed range 5 to 40 WPM. Always ready—no QRM.



**ENDORSED BY THOUSANDS!**

The Instructograph Code Teacher literally takes the place of an operator-instructor and enables anyone to learn and master code without further assistance. Thousands of successful operators have "acquired the code" with the Instructograph System. Write today for convenient rental and purchase plans.

**INSTRUCTOGRAPH COMPANY**

4701 Sheridan Rd., Dept. RC, Chicago 40, Ill.

## ROTA-BASE

**NEW HANDY LAB. DIAL.** Simply turn the movable dial to the tube number desired on the ROTA-BASE and complete correct connections are instantly indicated on the "prong" diagram. Filament, grid, plate, cathode, etc., to more than 300 tube types are given. No more valuable time lost on lengthy reading or thumbing of pages. ROTA-BASE actually gives a "prong" picture of the connections. **PRICE NOW ONLY \$1.00.** Postage prepaid or sent C.O.D. plus postage. Money back if not delightfully pleased.  
**REED MFG. CO.** 411 S. Main St. Los Angeles, Calif.

## Supplying Every Electronic Need

- FOR THE—
- RADIO SERVICE MAN
  - AMATEUR
  - STUDENT
  - EXPERIMENTER
  - INDUSTRIAL

WRITE FOR ILLUSTRATED PRICE LIST

**CRABTREE'S**  
**WHOLESALE RADIO**

DALLAS 2608 ROSS AVE. TEXAS

## ORDER NOW

Signal Corps 1-222A Signal Generator  
8 to 15, 150 to 230 MC.....\$69.95  
300 Ohm Amphphenol Twin Lead, per 100 ft..... 2.90  
75 Ohm Amphphenol Twin Lead, per 100 ft..... 2.00  
P23 Army Head Set, 8000 Ohm with 5 ft.  
Cord and plug..... 2.95  
3 Gang 410 MMFD, Per Section Condenser, Excellent Quality..... 2.95  
BC312 Army Receiver..... 59.95  
BC 312 converted for 110 VAC..... 79.95  
National ACN Dials..... 3.00  
4 MFD 600 Volt Oilfilled condenser, standard can mounting..... 1.59  
JAN type 2c40 Lighthouse tube, new in cartons 4.49  
Complete line of RCA, TAYLOR, GE, and EIMAC Tubes. Write Us Your Needs in Any Ham Equipment.

### DOW RADIO

1759 E. COLORADO PASADENA 4, CALIF.  
Pasadena Phone—Sycamore 3-1198  
Los Angeles Phone—RYan 16683

## IN STOCK!!!

Hammarlund HQ 129 & SPKR..... 173.25  
Hammarlund Super Pro & SPKR..... 338.25  
RME "45" & SPKR..... 198.70  
Also Complete Line of Ham and Service Equipment

**Standard Electronic Distributing Co. Inc.**

1497 MAIN STREET GA. 5000 BUFFALO 8, N. Y.

## RADIO TERM ILLUSTRATED

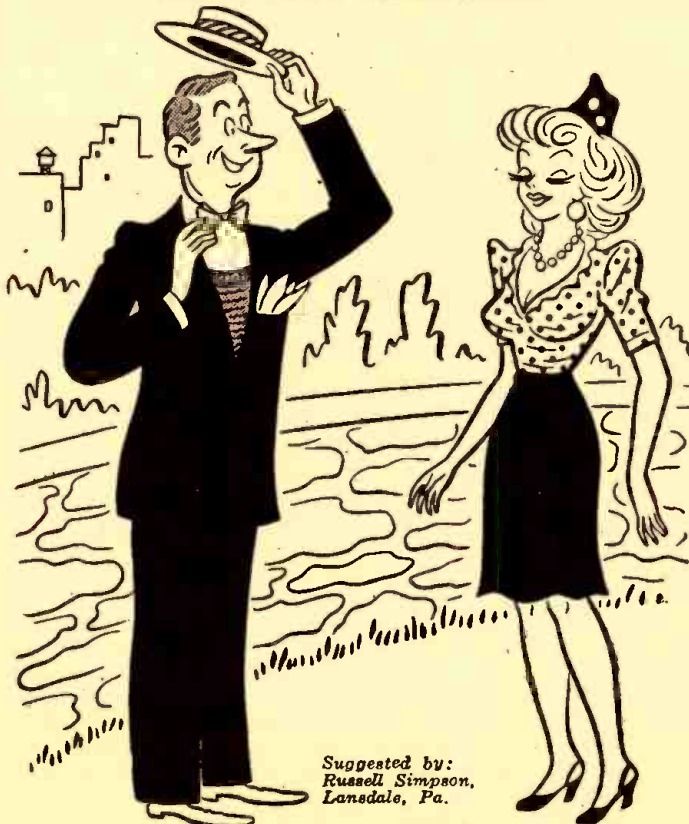

Suggested by:  
Russell Simpson,  
Lansdale, Pa.

MAGNETIC PICKUP!



# RADIO SCHOOL DIRECTORY

PREPARE NOW FOR SKILLED JOBS IN RADIO AND ELECTRONICS

## CAREERS in RADIO

**INTENSIVE COURSES**—Thorough, technical education for progressive men and women.

1. **RADIO TECHNICIAN**—The MRI General Course. Includes F.M. & Television. Prepares for FCC Broadcast Licenses.
2. **RADIO & TELEVISION SERVICING**—Prepares for employment as Repairman on Standard Broadcast, F.M. & Television Receivers.
3. **RADIO COMMUNICATIONS**—Prepares for FCC Operators' License. Leads to position as Merchant Marine or Flight Radio Officer; Commercial Operator.
4. **FUNDAMENTAL RADIO MATHEMATICS**—The MRI Preparatory Course. Required pre-training for students lacking a basic mathematical background.

**MELVILLE RADIO INSTITUTE**  
45 W. 45th St., N. Y. 19, BR 9-5080

"The Radio School Managed By Radio Men"

Licensed by the State of New York

**MELVILLE RADIO INSTITUTE**  
45 West 45th St., New York 19, N. Y.

GENTLEMEN: RC  
Send me FREE Information about your school.

Name.....

Address.....

MAIL THIS COUPON NOW

### HAM STATION FROM SURPLUS

(Continued from page 30)

normal a.v.c. operation is permitted. Closing the switch removes this voltage.

The amateur experimenter may make other improvements such as adding a vernier dial or connecting the output of the 6B8-G amplifier to the input of the interphone amplifier. A loudspeaker may be connected into the plate circuit of the 6V6-G power amplifier V8B.

The over-all gain of the set may be improved by reducing the value of the cathode bias resistors in the r.f. amplifiers. Under no conditions should these be reduced to the point of instability.

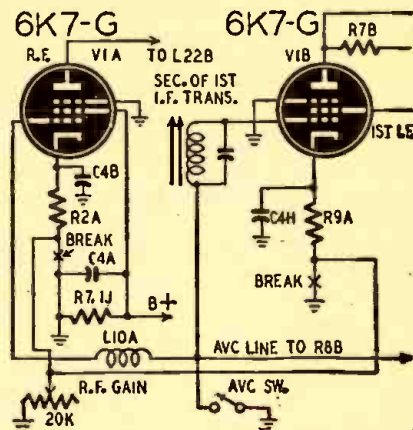

Fig. 4—A.v.c. and r.f. gain control details.

## Radio Men Needed

The Finest in Radio Training

Train for well-paid positions in Radio Engineering, Television, Electronics. Thorough courses in frequency modulation, math, mechanical drawing, construction, repair, aviation and police systems, sales and service, broadcasting.

APPROVED FOR VETERANS UNDER GI BILL

Low Tuition and Living Costs. Fine Climate—Hunting and Fishing. New Classes Start Each Month. Write

COL. H. C. WASHBURN Dept. 4 CLOVIS, NEW MEXICO

## Benson Radio Institute

**RCA INSTITUTES, Inc.**

Offer thorough training courses in all technical phases of Radio and Television

**VETERANS:** RCA Institutes is approved under G. I. Bill of Rights

For Free Catalog Write Dept. RC-47  
**RCA INSTITUTES, Inc.**  
A Radio Corporation of America Service  
75 VARICK STREET NEW YORK 13, N. Y.

## COMMERCIAL RADIO INSTITUTE

A radio training center for twenty-six years.

RESIDENT COURSES ONLY

Broadcast, Service, Aeronautical, Television and Marine telegraphy classes now forming. Literature upon request. Veteran training. Classes now forming for mid-year term, Feb. 1st. Entrance exam, Jan. 13.  
Dept. C. 38 West Biddle St., Baltimore 1, Md.

## LEARN RAPID RADIO SERVICING

Send for Free Information: "3 Ways to Learn Radio." Approved for Training Veterans.

**WESTERN RADIO INSTITUTE**  
1457 Glenarm, Denver 2, Colo.

## RADIO COURSES

- RADIO OPERATING
- RADIO SERVICING — ELECTRONICS
- REFRIGERATION SERVICING

Personal Counselling Services for Veterans  
Write for Latest Trade & Technical Catalog  
**Y.M.C.A. TRADE & TECHNICAL SCHOOLS**  
4 W. 64th Street New York City

## CORRESPONDENCE COURSES IN RADIO and ELECTRICAL ENGINEERING

**ELECTRICAL ENGINEERING** Get good grasp of wide electrical field. Prepare yourself at Low Cost, for secure future. Modern course. So simplified anyone can understand quickly.

**RADIO ENGINEERING** Extra fine course in radio, tube technician. Servicemen needed badly. Diploma on completion. Many graduates earning big pay.

Send postcard for Free Copies of school catalog, full details, all about deferred payment plan, experimental kits, etc.  
**WRITE \$25** Either  
Lincoln Engineering School, Box 931C—96, Lincoln 2, Nebr.

## RADIO

RADIO Technician and Radio Communications courses. Register now for new classes starting first MONDAY of each month. Day and Evening Classes.

**AMERICAN RADIO INSTITUTE**  
101 West 63rd St., New York 23, N. Y.  
APPROVED UNDER GI BILL OF RIGHTS.

## LEARN

### RADIO—TELEVISION—FM

Complete courses in all phases given in both day and evening classes.

Veterans accepted under G.I. bill

**United Radio Television Institute**  
225 Halsey Street Newark 2, N. J.

## CODE SENDING SPEED

Be a "key" man. Learn how to send and receive messages in code by telegraph and radio. Commerce needs thousands of men for jobs. Good pay, adventure, interesting work. Learn at home quickly through famous Candier System. Write for FREE BOOK.

**CANDLER SYSTEM CO.**  
Dept. 3-B, Box 928, Denver 1, Colo., U.S.A.

## RADIO COURSES

Servicing, Broadcast Engineering, Commercial Operating, Television  
INDIVIDUAL LABORATORY WORK—LEARN BY DOING!  
DAY AND EVENING CLASSES

Approved by the Maryland State Department of Education and the Veterans Administration

FREE TO VETS—TEXTBOOKS, TOOLS, TEST SET

Write for Bulletin  
**BALTIMORE TECHNICAL INSTITUTE**  
1425 Eutaw Place—Dept. C. Baltimore 17, Maryland

## BOOK REVIEWS

(Continued from page 79)

selsyns or synchros, and electronic motor control units. Each type of motor is discussed at length in a separate section that is concluded with a quick-

## THE RADIO PEN IN EUROPE

(Continued from page 71)

America only is capable of making something exceptional, that for many, news from America is as true as words from the Gospel!

"A 4-tube radio in a Fountain Pen! Why not, if the Pen is American!"

"Paris in a glass Bottle! Why not, if the bottle is American!"

Another technical magazine which joined the ranks of those who were taken in was the Italian technical magazine *L'Antenna*. In their issue of September, 1946, they reprinted the article and even went to the trouble to redraw the April Fool diagram solemnly. *L'Antenna* started the article by stating that the Radio Pen was manufactured by "Utis Electronic Corporation"—without stopping to think what the word meant. Utis is a character from the old Greek mythology. The word means, literally—Nobody!

Evidently RADIO-CRAFT's April Fool joke has come home to roost!



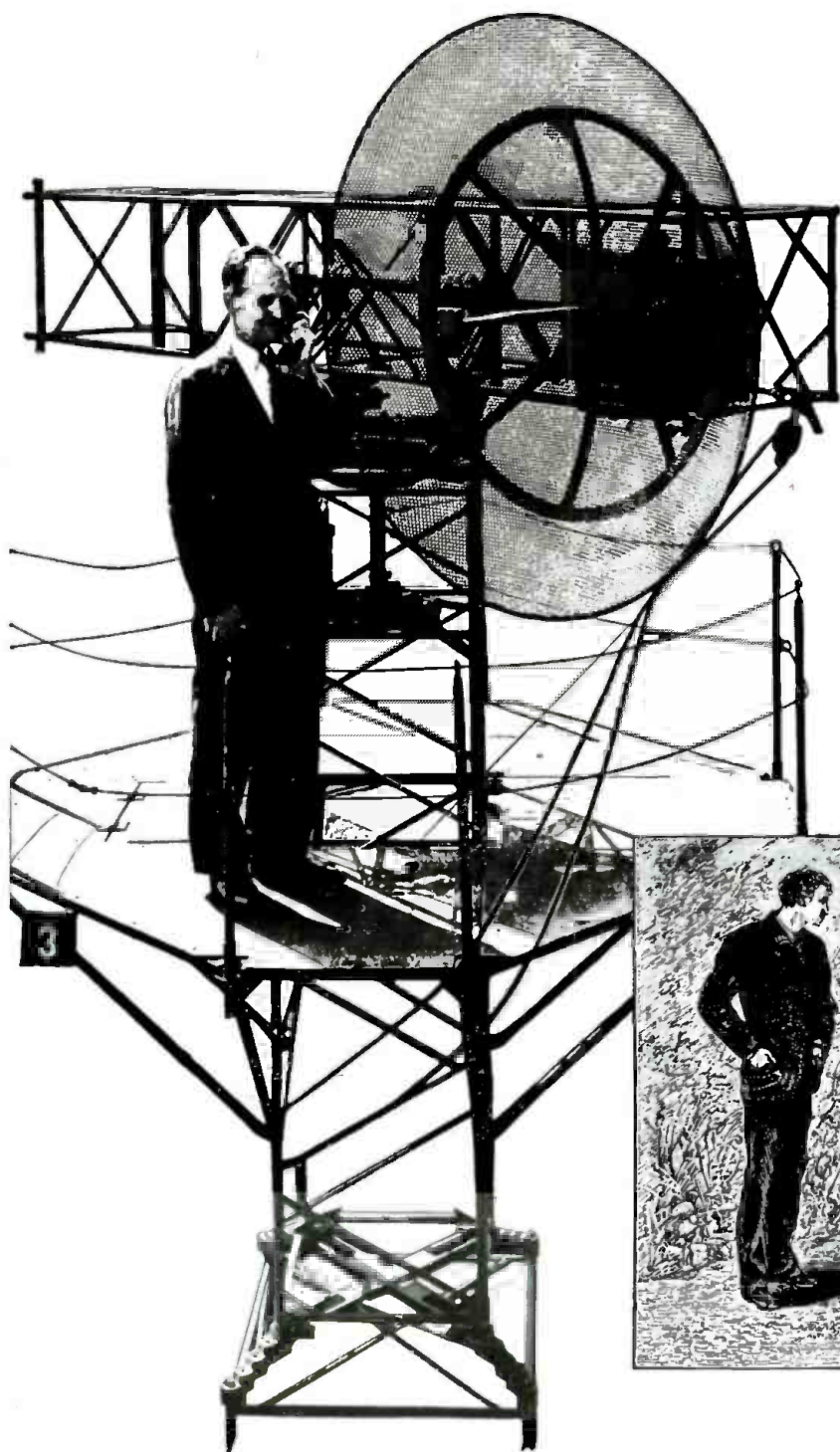

## Words that rode on a beam of light

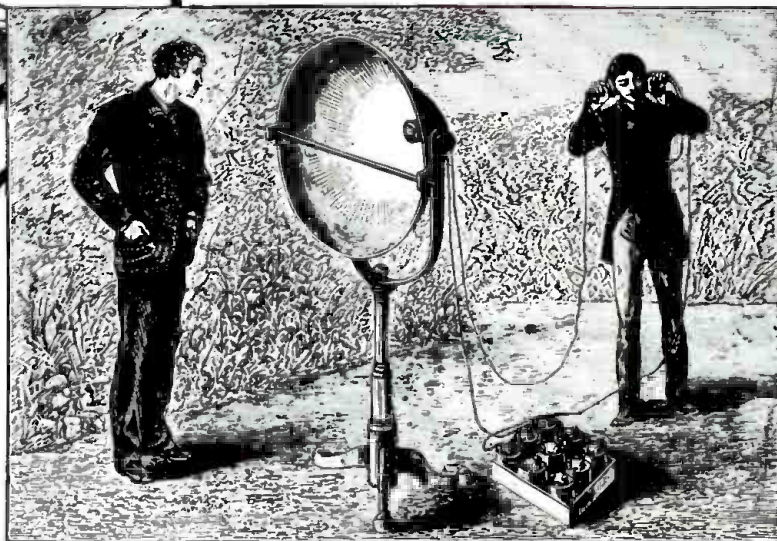

**I**F Alexander Graham Bell could look at the microwave antenna in the illustration, how quickly his mind would go back to his own experiments, 67 years ago!

For in 1880 the inventor of the telephone had another new idea. Speech could be carried by electric wires, as Bell had demonstrated to the world. Could it be carried also by a light beam?

He got together apparatus—a telephone transmitter, a parabolic reflector, a selenium cell connected to hand-phones—and “threw” a voice across

several hundred yards by waves of visible light, electromagnetic waves of high frequency.

Bell's early experiment with the parabolic antenna and the use of light beams as carriers was for many years only a scientific novelty. His idea was far ahead of its time.

Sixty years later communication by means of a beam of radiation was achieved in a new form—beamed

microwave radio. It was developed by Bell Telephone Laboratories for military communication and found important use in the European theater. In the Bell System it is giving service between places on the mainland and nearby islands and soon such beams will be put to work in the radio relay.

In retrospect, Bell's experiment illustrates once again the inquiring spirit of the Bell System.

**BELL TELEPHONE LABORATORIES**





**THEY'RE BETTER THAN EVER**

*and they cover  
every requirement*

- 1** Better impregnation to eliminate moisture
- 2** Better hermetic sealing for longer life
- 3** Quality control during manufacture



## MALLORY PAPER TUBULARS

**Y**OU want quality in the paper tubulars you buy — of course! Otherwise your replacement work won't stand up. Mallory gives you the quality you want.

But Mallory gives you quantity, too. Quantity in a wide assortment of ratings

and sizes that meet all requirements that come your way.

That's the story in a nut shell—whether you're looking for wax impregnated cardboard tubulars or oil impregnated ones. The Mallory Catalog and your Mallory Distributor both prove that—

**➔ YOU EXPECT MORE AND GET MORE... FROM MALLORY**

**P. R. MALLORY & CO. Inc.**  
**MALLORY**

VIBRATORS . . . VIBRAPACKS\* . . . CAPACITORS . . . VOLUME  
CONTROLS . . . SWITCHES . . . RESISTORS . . . FILTERS  
. . . RECTIFIERS . . . POWER SUPPLIES.

\*Reg. U. S. Pat. Off.

**APPROVED PRECISION PRODUCTS**

**P. R. MALLORY & CO., Inc., INDIANAPOLIS 6, INDIANA**

*Stephens F*